

EGSC
Fall Semester 2020 Return to Campus Plan
Revised 07/12/2020

ARCHIVED
The COVID-19 Public Health Emergency Declaration ended at midnight on May 11, 2023.
Information for archival use only.

USG Guidelines for Developing This Plan

EGSC State Georgia College (EGSC) has adopted this plan in accordance with the guidelines provided by the University System of Georgia (USG), including the following:

“The plan is for all USG (USG) institutions **to begin the fall semester face-to-face**. It is important to bring our students back to our campuses so that they may engage in the full higher education experience, which we have all invested much time in developing. **The health and safety of our students, faculty, and staff are our top priority.**

With that priority in mind, the USG will work in tandem with the Governor’s office, the Governor’s COVID-19 Task Force, and the Georgia Department of Public Health (GDPH) to make public health-informed decisions affecting the status of any of our campuses or our system.

The future for the next months and possibly year(s) is uncertain due to COVID-19. This uncertainty will require robust planning, coupled with extreme flexibility. We cannot predict what the circumstances will be for the start of the 2020- 2021 academic year or during any part of the fall term; however, we can develop plans that account for some of the scenarios under which we might be asked to begin the fall term. **There are multiple scenarios for the fall semester for which institutions should have plans.**

1. **Academic Year 2020-2021 Start – Fall classes begin with limited social distancing expectations**
2. **Contingency Plan 1 – Fall classes begin with social distancing expectations**
3. **Contingency Plan 2 – Fall classes begin fully online**
4. **Contingency Plan 3 – Classes and operations must go to an online format for a period of time during the semester**

Classes and operations must be able to go between best practices in face-to-face and online delivery for a period, based on public health information during the semester. **Each institution must be prepared for a disruption in the fall semester based on the fluid situation.** While we have proven we can move to an online environment very quickly, we now need to develop and implement best practices for moving to the online environment.”

Fall Semester 2020 Return to Campus Plan - Introduction

The COVID-19 pandemic has presented the world, the nation, Georgia, our region and local community and EGSC with unprecedented challenges. Responding to these challenges has caused sudden changes to the manner in which EGSC carries out its responsibility to serve as a point of access to a high quality, affordable college education. EGSC has learned from the experience of implementing these challenges and is committed to returning its operations in Fall Semester 2020 to a “new normal” – returning to an environment which includes the physical presence of students on our campuses in a manner which allows learning to continue and thrive while preserving health and safety. **EGSC is committed to providing students, faculty, and staff with an environment where a culture of learning based on scholarship, leadership and creative expression can continue to thrive despite the continuing impact of the COVID-19 pandemic.**

EGSC’s policies and protocols for returning to the new normal in the face of the COVID-19 pandemic is based in an understanding of EGSC’s responsibility to provide for safety for staff, faculty, students, guests, and the community we serve. It is also based in an understanding of our responsibility to provide a vibrant learning culture on our three campuses in the face of the pandemic.

Guiding Principles for EGSC's Return to Campus Plan

The following principles guided the formulation and adoption of this plan for return to “normal operation” at the beginning of Fall Semester 2020 – a return to campus of the students, faculty, and staff of EGSC.

- **Continual change** during the period of time covered by this initial return to campus plan is a certainty. We **must adapt continually**.
 - Change in the underlying crisis (the COVID-19 pandemic)
 - Change in the orders of the federal and state government
 - Change in USG directives
 - Change required by CDC or Georgia Department of Public Health guidance
 - Change required by internal evaluation of whether this plan is working (see below)
- It is **important to continually and regularly assess this plan** to determine if this plan is working well; and it is important to modify the plan as needed in response to these evaluations
- It is **important to coordinate our plan with the plans of our sister institutions (GaSouU and AU)** since EGSC operates programs in Statesboro and Augusta in partnership with those institutions
- Our three sites (Swainsboro, Statesboro, and Augusta) are not currently accessible by students or the public except in strictly limited situations. Faculty and staff are now permitted access only when they are essential (compliance with the “critical infrastructure requirements of the Executive Orders of the Georgia Governor). **Transition from this current status to “normal operations” during Fall Semester 2020 should be accomplished in three orderly stages allowing regular evaluation and change to this plan as needed.**
- **Health and safety are a top priority** in designing this plan.
 - Maintaining accepted standards for **social distancing** is a priority
 - Use of **physical barriers** (e.g., acrylic shields, partitions, defined pedestrian pathways) and re-configuration of office spaces to limit physical contact whenever to supplement social distancing is a priority
 - Emphasis on the importance of regular and thorough **handwashing** is a priority
 - Meeting accepted standards for continually and regularly **cleaning, disinfecting and sanitizing campus** is a priority. For purpose of this plan, these terms are defined as follows:

Cleaning removes germs, dirt, and impurities from surfaces or objects. Cleaning works by using soap (or detergent) and water to physically remove germs from surfaces. This process does not necessarily kill germs, but by removing them, it lowers their numbers and the risk of spreading infection.

Disinfecting kills germs on surfaces or objects. Disinfecting works by using chemicals to kill germs on surfaces or objects. This process does not necessarily clean dirty surfaces or remove germs, but by killing germs on a surface after cleaning, it can further lower the risk of spreading infection.

Sanitizing lowers the number of germs on surfaces or objects to a safe level, as judged by public health standards or requirements. This process **works by either cleaning or disinfecting** surfaces or objects to lower the risk of spreading infection.

- Emphasis on **the personal responsibility** of all persons on campus for the health and safety of themselves and others on campus is a priority. Accordingly:
 - Providing all persons on campus with convenient access to a sufficient **supply of appropriate disinfectants** (hand sanitizers disinfectant wipes) is a priority
 - Requiring that all persons on campus **wear protective face coverings** as directed in the July 6, 2020 email from the USG:
 - “Effective July 15, 2020, University System of Georgia (USG) institutions will require all faculty, staff, students, and visitors to wear an appropriate face covering while inside campus facilities/buildings where six feet social distancing may not always be possible. Face covering use will be in addition to and is **not** a substitute for social distancing.
 - Face coverings are not required in one’s own dorm room or suite, when alone in an enclosed office or study room, or in campus outdoor settings where social distancing requirements are met.
 - Anyone not using a face covering when required will be asked to wear one or must leave the area. Repeated refusal to comply with the requirement may result in discipline through the applicable conduct code for faculty, staff or students.
 - Reasonable accommodations may be made for those who are unable to wear a face covering for documented health reasons.”
- Conducting **meetings by electronic or telephonic means** whenever possible is a priority
- **Limiting classes, meetings, events, and gatherings to a size which permits appropriate social distance** in the gathering space is a priority
- **Education of the campus community** using multiple methods about best practices and this plan is a priority
- **Staggering work schedules** to minimize the likelihood of physical contact on campus is a priority
- **Scheduling classes to minimize the likelihood of physical contact** on campus is a priority. (staggered class beginning and ending times, use of hybrid classes when possible)
- Adherence to **ban on state travel** is a priority
- This plan relies on current CDC, GDPH and USG guidelines. In addition, this plan is informed by and relies upon the *ACHA Guidelines, Considerations for Reopening Institutions of Higher Education in the COVID-19 Era*. **See Attachment A.**

- It is **important to build the framework for health and safety implemented by EGSC during Spring Semester 2020 and continued during Summer Semester 2020 since faculty and staff are familiar with that model, it has worked effectively and the direct involvement of EGSC unit heads (a review not less than weekly review of work schedules of all employees in their unit) has assured that those unit heads have ownership and direct oversight of this plan.**
- **Communication on a regular (not less that weekly) basis with all key constituencies (students/faculty and staff/community) is a priority.**
- It is a top priority to **provide faculty and staff with the working conditions which will enable them to complete their important work.**

ARCHIVED
The COVID-19 Public Health Emergency Declaration ended at midnight on May 11, 2023.
Information for archival use only.

The Role of Personal Responsibility in Carrying Out this Plan

The success of any plan of this type is, of course, dependent upon the acceptance of personal responsibility by students, faculty, staff and guests for their own health and safety and the health and safety of others. Intentional effort by all faculty, staff, students, and guests is essential. This exercise of personal responsibility by all members of the EGSC community will create a culture that sustains a safe and healthy environment.

ARCHIVED
The COVID-19 Public Health Emergency Declaration ended at midnight on May 11, 2023.
Information for archival use only.

The Role of Law, Policy and Guidelines of Governing Bodies in this Plan

EGSC's plans for returning to normal operations in Fall Semester 2020 and increasing the presence of faculty, staff, students and guests will require adherence to a wide range of policies, laws and guidance at the federal, state and local level. Those policies, laws and guidance will change continually due to the changing nature of the COVID-19 pandemic. EGSC will continually evaluate and modify this plan as needed in response to changes in the following:

- Executive Orders of the Georgia Governor;
- Directives of the Board of Regents of the USG;
- Local ordinances;
- Laws and Guidelines enacted by the Federal Government

EGSC plans for returning to normal operations in Fall Semester 2020 is also dependent in part upon the following:

- Resource availability: including PPE (Personal Protective Equipment) for students, faculty, staff and guests;
- Availability in the region of testing and contact tracing resources;
- Financial feasibility.

EGSC's plans for returning to normal operations in Fall Semester 2020 are also dependent upon rates of COVID-19 transmission locally, in the region and in the state; and upon the capacity of the health system to meet changing needs. EGSC recognizes that it is possible that, depending on these changes, a return to a prior phase of this plan or a return to the emergency restrictions of Spring and Fall Semester 2020 may become necessary.

EGSC's Return to Campus Plan

The following sections of this plan represent the work of 11 EGSC sub-committees charged with the responsibility to develop a return to campus plan for consideration by the college's Cabinet and COVID-19 Task Force. Members of the COVID-19 Task force are as follows:

Bob Boehmer, President

Terri Brown, Director of eLearning

Cliff Gay, VP for Business Affairs

Karen Jones, Associate VP for Student Affairs

Nick Kelch, Associate VP for External Campuses and Director of EGSC Augusta

Norma Kennedy, Associate VP for Executive Affairs and Interim AVP for Institutional Advancement

Dr. Carmine Palumbo, Director of Study Abroad

Mike Rountree, VP for Information Technology

Mack Seckinger, Chief of Police and Director of Public Safety

Dr. Sandra Sharman, VP for Academic and Student Affairs

Mary Smith, Chief of Staff and Legal Counsel

Angela Storck, Director of Housing

Dr. Linda Upchurch, Director of Nursing

Angie Williams, Director of Event Planning and Scheduling

Jessica Williamson, Director of EGSC Statesboro

Chuck Wimberly, Director of Athletics

Manner of Presentation of the EGSC Plan

EGSC, as directed by the USG, formed sub-committees to address components of this plan. The work of each sub-committee is presented separately below.

- Each sub-committee section first addresses EGSC’s Plan Under Contingency 1 (Fall Classes Begin with Social Distancing Expectations);
- Contingency 2 and contingency 3 are then addressed as needed by each sub-committee;
- The USG Guidelines identify certain mandatory questions for certain sub-committees. Those USG questions are presented **in green type** within each sub-committee’s report followed by EGSC’s response.

TABLE OF CONTENTS

Workplace & Health Safety Sub-committee	11
Academics & Research	37
Public Service, Outreach, Continuing Education & Cooperative Extension	65
Student Life (including residence life)	71
Enrollment Management	95
Athletics	123
Communications	134
Fiscal Impact	152
IT	158
External Campuses (Statesboro and Augusta)	163
Attachments	168

1. Workplace & Health Safety Sub-committee

- Mary Smith, Chief of Staff (Co-chair)
- Dr. Linda Upchurch, Director of Nursing (Co-chair)
- Tracy Woods, Director of Human Resources
- David Steptoe, Director of Plant Operations

The following is the plan of the Workplace & Health and Safety Sub-committee.

CONTINGENCY PLAN #1 (Fall Semester 2020 Classes Begin with Social Distancing Expectations)

Action steps Necessary to Carry Out this Plan

Implement an Education and Awareness Plan

EGSC will educate employees and students on information related to COVID-19 prior to their return to campus. **Central to the success of the education campaign and to ensuring a healthy environment is personal responsibility.** EGSC's education awareness will emphasize the importance of personal responsibility during this pandemic. Students and employees will receive weekly emails communicating COVID-19 awareness and recommended preventive measures each can practice. In addition, the EGSC homepage will display a COVID-19 Information and Resources banner which informs the community and visitors that EGSC has adopted CDC's preventive measures. EGSC will create a campus reopening video to educate employees and students on changes and expectations for Fall 2020. The video will be an integral part of the student and employee training along with the EGSC COVID-19 Health and Safety Protocols Acknowledgement and Personal Responsibility document which emphasizes personal responsibility for the safety of the campus community. See Attachment I [this paragraph revised as of 07/05/2020]

EGSC will use the CDC's educational sources to educate students and employees on the following:

- Instruction for proper type of face coverings, wearing, care and storage;
- Safe hygiene practices for hand washing, cough and sneeze etiquette;
- What to do for suspected illness;
- What to do if contact with those who have been exposed to the virus or have the virus;
- Caring for someone who is in higher risk category; and
- Other GDPH, CDC or USG guidance that may become available.

EGSC's education and awareness campaign will include educational materials, signage, webpages and videos providing information and instruction to students and employees on COVID-19. EGSC will, across all campuses, implement social distancing, implement the use of physical barriers (acrylic screens, partitions) where needed, increase the number of hand hygiene stations, further enhance sanitation practices, require face coverings of all employees, students and visitors in indoor spaces, require that all meetings be electronic or telephonic, where possible.

Educational materials will be posted on the EGSC webpage, including an instructional video on the webpage for this purpose, building entrances, in classrooms and labs, various locations in the student

center, dining hall, housing, library and ACE, gym and fitness center, employee breakrooms and all restrooms.

See also the report of the Communications Committee below.

Implement Measures to Promote Healthy Environment

EGSC will implement measures as recommended by USG, GDPH and CDC:

- Face coverings will be required as indicated below;
- Social distancing will be required as indicated below;
- Physical barriers will be installed when social distancing is not possible; and
- Space and equipment sharing will be avoided when possible.

EGSC will require face coverings of everyone in indoor spaces on campus as required by the USG directive (see above). EGSC will provide a limited supply of protective face coverings. However, acquiring a face covering will be the responsibility of the wearer unless the use is part of the person's job responsibility (facilities and food services). It is the personal responsibility of students and employees to acquire their own face covering. The EGSC Bookstore will have a small supply of face coverings available for purchase on-line and in the campus bookstore.

To ensure social distancing, physical barriers will be placed in work areas to separate workspaces where maintaining 6 feet apart is currently not possible due to the space layout. Acrylic shields barriers will be used in workspaces where staff are required to meet face-to-face with individuals and students.

Floors will be marked with tape to indicate allowed social distances (enrollment management offices, student life offices, etc.) so that students may be served in person.

EGSC will eliminate desk, computer and other equipment sharing by using telework or assigning an alternate temporary space if available. If office equipment sharing must continue (copiers, printers, scanners in suites) then each employee will be instructed to sanitize the equipment before and after use. All employees will be required to sanitize their personal workspaces daily with supplies provided by EGSC, paying close attention to high touch areas such as doorknobs, telephones, keyboards, etc. This cleaning by employees is in addition to regular daily cleaning by EGSC custodial staff as noted herein.

When faculty return to campus they will be expected to practice social distancing and avoid gathering in the hall and common areas. Faculty office schedules will be staggered to the extent possible. EGSC will require all workplace meetings to be held via virtual/electronic resources wherever possible to limit gatherings. [this paragraph revised as of 07/05/2020]

Timeline for Action Steps

Action	Unit(s) with Primary Responsibility (in collaboration with the Workplace and Safety Committee)	Timeline for completion
Education and awareness;	Workplace and Safety	June 1, 2020 (or when plan

developing plan	Committee	approved by USG)
myEGSC or D2L risk acknowledgment and pledge for students, faculty, and staff	Information Technology	By June 15, 2020 (or prior to any return to campus)
Placing CDC educational signage throughout all 3 campuses in strategic locations	Communications department; facilities management	June 1, 2020 (or when plan approved by USG)
Creating educational video for website and campus TV system announcing safety requirements of all on campus	Communications department	By June 15, 2020 (or prior to any return to campus)
Ensure all work and classroom spaces prepared for adequate social distancing. If unable due to space limitations, provide barriers and screens as protective measures	Facilities management; Business Office (purchasing)	By June 15, 2020 (or prior to any return to campus)
Place tape or other directional signages throughout campus in strategic locations to mark appropriate social distancing locations (or to prevent use of workstations closer than 6' in areas such as computer labs or classrooms with fixed seating)	Communication department; facilities management. Units to inform Communications department of needed signage	By June 15, 2020 (or prior to any return to campus)
Ensure hand sanitizing stations and hand soaps available throughout all 3 campuses in appropriate and strategic locations	Facilities management; Business Office (purchasing)	By June 15, 2020 (or prior to any return to campus)
Have face coverings in the Bookstore for purchase	Bookstore management, EGSC Business Office	By June 15, 2020 (or prior to any return to campus)
Ensure technology available to all staff/faculty to facilitate virtual meetings	Information Technology; unit leaders/Deans	By June 15, 2020 (or prior to any return to campus)
Ensure all staff/faculty have exclusive use of items such as telephones or office equipment. If unable, have approved cleaning supplies available for cleaning by the user in between uses.	Information Technology; Deans/unit leaders to request needed items; facilities management for cleaning supplies; business office for purchasing	By June 15, 2020 (or prior to any return to campus)
Purchase of approved cleaning, disinfecting and sanitizing equipment, solutions, and personal safety equipment for use	Facilities management; business office for purchasing	By June 15, 2020 (or prior to any return to campus)

by facilities personnel		
Staggered work schedules as needed for all staff or faculty to ensure social distancing	Deans/unit leaders/VPASA	By June 15, 2020 (or prior to any return to campus)
Assess for staff/faculty at high risk for COVID-19; offer alternative work schedules or telework	VPASA; Deans/unit leaders/Human Resources	By June 15, 2020 (or prior to any return to campus)

Specific Topics to be Covered in Plan to Educate the EGSC Community

(See, also, the Communications Sub-committee’s plan below concerning the communication techniques which will be used)

Content Topic	Audience	Timeline	Content Owner	Critical Points	Method of Communication
Workplace and Health Safety	Students, Staff, Faculty, Visitors, Vendors, Community	Before faculty/staff or students return to campus; proposed date – June 1, 2020	Mary Smith, Linda Upchurch	<p>1) Ensuring a healthy campus environment while meeting Mission of the college</p> <p>2) Educate audience on information relative to COVID-19 and campus safety measures (via video announcements, printed signage, D2L and myEGSC acknowledgments, printed letters and email, and webpage announcements)</p> <p>3) Highlighting personal responsibility as critical to safety of all</p> <p>4) Formulate a</p>	<p>Email, printed letters, printed signage, D2L announcements, campus TV network, webpage; video</p> <p>(All materials to be recommended and reviewed by Workplace and Health Safety Committee, Human Resources, and EGSC administration prior to implementation)</p>

				<p>plan for hygiene practices while on campus (face coverings, hand washing, use of hand sanitizers, and user cleaning of facilities)</p> <p>5) Formulate a plan for ensuring appropriate social distancing practices (room spacing, virtual meeting, outdoor dining options, etc.)</p> <p>6) Monitoring for changes in safety practices recommended by CDC and GDPH guidelines</p> <p>7) Evaluating effectiveness of safety measures. Make recommendations per outcomes, including need to transition to all online format (as in Spring Semester 2020 plan)</p>
--	--	--	--	---

All communication materials will be created or printed by EGSC. Printed educational materials are available for use free of charge and are found on the CDC website. The Workplace & Health Safety Committee has collaborated with the EGSC Communication Department to determine which resources will be printed and the locations on campus where those posters/handouts will be located. Videos and web announcements will also be created in-house. Samples of communications include:

- 1) Signs demonstrating handwashing techniques will be posted in restrooms;

- 2) “Stop, do not enter if you are sick/have symptoms” signs will be posted at building entrances;
- 3) Educational videos will display on campus TVs;
- 4) Video announcing safety practices that have been implemented will be posted on the EGSC website and sent to students, faculty, and staff via email prior to return to campus;
- 5) Printed handouts for education regarding symptoms of COVID-19 will be placed in strategic locations on campus and sent via email to students, faculty, and staff; and
- 6) Signage indicating social distancing requirements in all areas; specific signage for small areas where social distancing may not be possible (restrooms, breakrooms, etc.) to limit the number of individuals in the area at one time.

Standards for Social Distancing

EGSC will follow *CDC Guidance for Institutes of Higher Education (Attachment B)*, including, but not limited to:

- Small in-person classes, activities, and events. **Individuals remain spaced at least 6 feet apart and do not share objects (e.g., hybrid virtual and in-person class structures or staggered/rotated scheduling to accommodate smaller class sized).**
- Staying home or self-isolating when appropriate
- Hand hygiene and respiratory etiquette
 - Handwashing and use of hand sanitizers
 - Cover coughs and sneezes with a tissue or inside elbow. Dispose of used tissues in trash and wash hands.
- Cloth face coverings
- Adequate supplies
- Signs and messages
- Cleaning and disinfection
- Discourage use of shared objects
- Adequate ventilation
- Modified room layouts
- Physical barriers and guides
- Partitions, shields, and tape markers
- Barriers in communal spaces, such as restrooms
- Modified food service plan
- Virtual meetings
- Travel ban
- Communication

See website:

<https://www.cdc.gov/coronavirus/2019-ncov/community/colleges-universities/considerations.html#principles>

Standards for Regular Cleaning, Disinfecting and Sanitizing of Physical Spaces on Campus

EGSC will follow *USG Coronavirus Disease 2019 (COVID-19) Implementation Guidance for Facilities Officers – Custodial Operations Focus* dated March 25, 2020 for custodial operations and cleaning intervals and response. The guidance is based on industry recommendations. The USG guidance, EGSC's plan for cleaning the student health center and the student health clinic staff's cleaning procedures are attached to this document as **Attachment C**. EGSC Employees will be responsible for cleaning and disinfecting their own personal workspaces daily. This responsibility will be included in all employee COVID-19 educational materials. [This paragraph revised as of 07/05/2020].

EGSC will place additional hand-sanitizing stations in prime locations throughout buildings and workspaces and increase monitoring to ensure that soap dispensers in restrooms and lab spaces are continuously filled and maintained. EGSC will equip each classroom and lab with hand sanitizer, provided supplies can be obtained. EGSC will follow the USG facility sanitation guidelines as discussed in later sections of this plan.

Recommended Standards for Personal Hygiene

EGSC will follow the hand hygiene recommendations by the CDC, *When and How to Wash Your Hands*; See **Attachment D**. Education and signage will reinforce these practices, to include:

How germs spread

Touching eyes, nose, and mouth with unwashed hands

Preparing or eating food and drinks with unwashed hands

Touching contaminated surfaces or objects

Blowing nose, coughing, or sneezing into hands and then touching other people's hands or items

Key times to wash hands:

- **Before, during, and after** preparing food
- **Before** eating food
- **Before and after** caring for someone at home who is sick with vomiting or diarrhea
- **Before and after** treating a cut or wound
- **After** using the toilet
- **After** changing diapers or cleaning up a child who has used the toilet
- **After** blowing your nose, coughing, or sneezing
- **After** touching an animal, animal feed, or animal waste
- **After** handling pet food or pet treats
- **After** touching garbage
- **After** touching items frequently touched by others (door handles, gas pumps, shopping carts, cashier registers/screens
- Use hand sanitizer when you can't use soap and water

Five steps to wash hands the right way

Follow these five steps every time.

1. **Wet** your hands with clean, running water (warm or cold), turn off the tap, and apply soap.
2. **Lather** your hands by rubbing them together with the soap. Lather the backs of your hands, between your fingers, and under your nails.
3. **Scrub** your hands for at least 20 seconds. Need a timer? Hum the “Happy Birthday” song from beginning to end twice.
4. **Rinse** your hands well under clean, running water.
5. **Dry** your hands using a clean towel or air dry them.

How to use hand sanitizer

- Apply the gel product to the palm of one hand (read the label to learn the correct amount).
- Rub your hands together.
- Rub the gel over all the surfaces of your hands and fingers until your hands are dry. This should take around 20 seconds.

Standards for Wearing of Personal Protective Equipment (PPE)

Currently, this plan provides that everyone is required to wear protective face coverings as provided in the above USG directive. A limited supply of protected face coverings will be provided by EGSC. However, employees are responsible for acquiring their own protective face coverings unless the job duties require special face coverings (cafeteria and facilities management). EGSC will provide PPE for those employees only. Central to the success of the implementation of EGSC’s preventive measures is the personal responsibility of employees.

Standards for PPE

Facilities management and cafeteria staff will follow guidelines for PPE by their individual governing bodies (EPA, CDC, etc.). Students and employees will be provided guidance on proper wearing of face coverings and how to make a face covering. See *CDC Use of Cloth Face Coverings to Slow the Spread of COVID-19. Attachment E.*

Monitoring of the Health of Individuals on Campus

(See also later in this plan: Testing and Screening of Employees)

While current CDC and Georgia Department of Public Health (GDPH) workplace reopening guidelines recommend testing of employees where feasible, **EGSC currently lacks resources to test its employees.** Third party provider testing provided by USG to institutions would assist EGSC in this process.

Beginning Fall semester 2020, employees will be asked to self-monitor for symptoms of COVID-19 and report illness to his/her supervisor. A sample self-assessment questionnaire from the Mayo Clinic illustrates the COVID-19 symptoms. See *Mayo Clinic COVID-19 Self-Assessment Tool. Attachment F.* [This paragraph revised as of 07/05/2020]

Employees will exercise personal responsibility to report symptoms to his/her supervisor and leave work when ill. EGSC will follow CDC and GDPH guidelines for sending sick employees home, notifying EGSC Human Resources of this action and notifying employees of to seek medical care. EGSC will respond to suspected and confirmed cases of COVID-19 as indicated in the *EGSC Supervisor Guidance Regarding Employee Illness or Absence During COVID-19 (Attachment G)*. EGSC's COVID-19 Campus Contact will cooperate with GDPH and the local health departments when necessary concerning contact tracing. EGSC will comply with HIPPA regulations regarding confidentiality of an employee's medical records. [This paragraph revised as of 07/05/2020].

Health and Safety Reporting

Students and employees will exercise personal responsibility to report symptoms, not come to campus when ill, and leave campus when becoming ill. Similarly, students and employees will exercise personal responsibility to report possible exposure to COVID-19 and to consult with and follow the advice of their healthcare provider. Unit leaders will inform Human Resources of employee absences due to COVID-19 for follow-up. Faculty will report student absences and/or suspected illness to unit leader and VPASA. Employees will be encouraged to contact healthcare provider for recommendations for testing or provider visit. Students will be encouraged to contact EGSC Student Health Services for testing. Employees and students with positive test results must follow GDPH guidelines for self-quarantine during illness. Students who live in student housing must follow guidelines for quarantine outlined by that department. [This paragraph revised as of 07/05/2020]

Everyone must have a "return to work/school" permission from healthcare provider before return to campus. EGSC will follow the GDPH Guidelines Concerning this topic.

If symptomatic and positive test, the following apply before return to work/school:

- No fever for at least 72 hours (3 full days without the use of fever reducing medication; AND
- Improved symptoms; AND
- Gone at least ten days since symptoms first appeared.

If asymptomatic and positive test, the following apply before return to work/school:

- 10 day quarantine after test and no symptoms during quarantine period;
- If symptoms arise during 10 day quarantine, the symptomatic rules above apply.

GDPH COVID-19 Non-healthcare personnel Return to Work Guidance After COVID-19 Illness or Exposure – 5/21/2020 Attachment V. [This paragraph revised as of 07/05/2020].

Healthcare providers, in collaboration with the GDPH will provide contact tracing activities for persons positive for COVID-19.

Written Acknowledgement of Risk

Vendors will be informed of EGSC's preventive measures and will be asked to read, acknowledge and agree to follow the measures while on campus. The vendor acknowledgement will include a waiver. Attached to the Acknowledgement is the CDC guideline *How to Stop the Spread*; all vendors will be provided a copy of this document. See *EGSC COVID-19 Acknowledgment and Waiver. Attachment H.*

As student, parent/guardians, visitors, applicants for employment and employees return to campus in Fall Semester 2020, each will be asked to read the *EGSC COVID-19 Acknowledgment and Pledge of Personal Responsibility*. Attached to the Acknowledgement is the CDC guideline *How to Stop the Spread*, adopted by EGSC as its health and safety protocol. **See Attachment I.**

Testing

See also later in the document, Testing and Screening of Employees

EGSC's on campus student health clinic is managed and staffed by a third-party provider and funded by student fees. The student health clinic provider is the local Swainsboro hospital, Emanuel Medical Center, which is a COVID-19 testing site. The clinic will provide COVID-19 testing for students. Student health clinic staff, in collaboration with the Georgia Department of Public Health, will perform contact tracing for those with positive test results. Students will be required to self-quarantine and must receive a "return to school" clearance from the student health clinic prior to return to classes. EGSC will follow the GDPH Guidelines Concerning this topic:

GDPH Covid-19 Non-healthcare personnel Return to Work Guidance After COVID-19 Illness or Exposure – 5/21/2020 Attachment V. [This paragraph revised as of 07/05/2020].

Students who are required to quarantine must work with faculty and VPASA to facilitate online learning during quarantine. Students who live on campus must follow student housing guidelines.

Students at the EGSC Augusta campus, located on the AU (AU) Summerville campus, through cooperative agreement with AU, would follow the AU testing provisions. Currently testing is provided by AU and is a covered service under the student health fee. Students at the EGSC Statesboro campus, located near the GaSouU (GaSou) campus, through cooperative agreement with GaSou would follow the GaSou testing provisions. GaSou's health clinic will conduct testing as a covered service under the student health fee. [This paragraph revised as of 07/05/2020].

Employees at all sites would be referred to their local healthcare provider for external testing or referred to AU's screening and referral website and app. If all employees are to be tested prior to Fall Semester 2020 start, EGSC would make this requirement known to its employees with a timeline for completion prior to the start of Fall semester 2020.

Ongoing Evaluation of this Plan

During all phases, departments, student housing, and student health services will complete a weekly report indicating numbers of faculty/staff/student absences or illness rates. These reports will be made available to EGSC Human Resources and the VPASA. If an uptrend of illness is indicated by absences, the committee and the administration will determine need for further mitigation or migration to fully online courses. The Workplace & Health Safety Committee will continue to monitor changes reported by the CDC and the GDPH and make recommendations based on those guidelines and instructions to Colleges and Universities.

Additional Considerations for Contingency Plan 1 as Provided in USG Guidelines

“Campuses are currently planning for a gradual and staggered return to campus for faculty and staff that includes provisions for social distancing. For the purposes of this planning document, you should assume that the expectations outlined in the gradual and staggered planning document remain applicable. Additional plans should be in place to bring all faculty and staff onto campus to resume normal operations but with social distancing practices in place.

Staff

The gradual and staggered return to campus plans will inform the ultimate full return of staff to the campus.

*Building on your plan for the gradual return, what additional actions will need to occur to ensure that the staff on campus are prepared to start the fall semester, including serving students in person, while also practicing social distancing whenever possible?”

See, also, EGSC Initial Return of Faculty and Staff to Campus Plan (separate document).

During Summer 2020, EGSC plans to gradually return staff to campus and allow limited student visits (one-on-one), by appointment only, with specific offices: Financial Aid, Library, Housing and Athletics. Each office will implement CDC guidelines concerning reopening workplaces including the practice of social distancing through six feet spacing between individuals, the use of physical barriers and acrylic shields. Floors will be taped to indicate social distancing spacing, signage will be placed throughout the office and the building, including restrooms, on social distancing, proper hand hygiene, proper cough and sneeze etiquette and the use of face coverings. Staff will be assigned staggered shifts and flexible schedules to minimize the number of staff in the unit where possible.

Campus law enforcement will continue to monitor the main entrance to campus in Swainsboro and Statesboro, allowing employees on campus only when approved by the employee’s supervisor per the supervisor’s weekly report provided to campus law enforcement each Friday for the following week. Students may visit campus by appointment only, when approved by the unit (Financial Aid, Library, Housing, Athletics), and after the unit head’s notification to campus law enforcement of student’s name, parent or guardian’s name, and the date and time of appointment. EGSC Augusta, located on the AU Summerville campus, will follow the protocol stated in AU’s Summer and Fall Semester 2020 plans.

Vendors will be informed of EGSC’s preventive measures and will be asked to read, acknowledge and agree to follow the preventive measures, including social distancing, while on campus. Attached to the Acknowledgement is the CDC guideline *How to Stop the Spread*; all vendors will be provided a copy of this document. See *EGSC COVID-19 Vendor Acknowledgment and Waiver*. **Attachment H**.

As students, parent/guardians, visitors, candidates for employment, as well as employees returning to campus in Summer 2020, will be asked to review and follow the *EGSC COVID-19 Acknowledgment and Pledge of Personal Responsibility*. Attached to the Acknowledgement is the CDC guideline *How to Stop the Spread*, adopted by EGSC as its health and safety protocol. **See Attachment I**. Unit heads are responsible for distributing Acknowledgments to employees in their unit. Offices receiving visitors by

appointment will be responsible for distributing Acknowledgement in advance of visitor's arrival on campus.

For Fall Semester 2020, several steps will need to occur **prior to Fall reopening**:

Implement Education and Awareness Campaign for Staff

During Spring Semester 2020, in compliance with the "critical infrastructure" requirements of the Executive Orders of the Georgia Governor, faculty and staff were permitted access to campus only when they qualified as essential employees or had permission of his/her supervisor. All remaining employees transitioned to telework. While on campus, employees were asked to practice strict social distancing, work staggered shifts, flexible hours, wear face coverings while inside campus buildings as required by the above USG directive, and clean and disinfect their personal workspace. All employees were instructed to conduct meeting via electronic means. As a result, only a limited number of employees have been on campus since the executive order was implemented. The remaining employees are likely not aware of the health and safety protocols needed in the workplace.

To prepare for the return of the campus population in Fall Semester 2020, EGSC's communications plan will provide education and awareness materials to staff to inform them of health and safety protocols and behavioral expectations while on campus. Educational materials will incorporate CDC and GPHS guidelines and will be modified as those guidelines are updated. Currently, this guidance provides that employees are required to wear protective face coverings as provided in the USG guidance. A limited supply of protective face coverings will be provided by EGSC. However, employees are responsible for acquiring their own protective face coverings, unless it is related to a specific job duty (cafeteria and facilities). In that case, EGSC will supply the face covering as appropriate to the task. Central to the success of the implementation of EGSC's preventive measures is the personal responsibility of employees. The education materials will emphasize the link between personal adoption of the protocols and overall campus health. Employees will be asked to acknowledge EGSC COVID-19 health and safety protocols, using updated materials as necessary to changing recommendations, and using the process implemented in Summer 2020. Unit heads will also be responsible for enforcing compliance with the health and safety protocols within their respective unit. [This paragraph revised as of 07/05/2020].

Signage will be posted on building exteriors and interiors with messaging appropriate for all campus areas, for specific spaces, and the health, safety and behavioral expectations of all individuals.

Messaging will also be prominently displayed on the closed-circuit TV monitors throughout campus, on all social media, and on the institution's COVID-19 webpage. A video providing information and instruction will be created, used as training for employees and students, and published on the website to inform the campus and the public of expectations. [This paragraph revised as of 07/05/2020.]

Implement EGSC Health and Safety Measures:

Required use of face coverings by employees as provided in the above USG directive;

Practicing accepted standards for social distancing and travel restrictions:

- Use of physical barriers (e.g., acrylic shields, partitions, defined pedestrian pathways) and re-configuration of office spaces to limit physical contact whenever to supplement social distancing
- Conducting meetings by electronic or telephonic means whenever possible
- Limiting physical classes, meetings, events and gatherings to a size which permits appropriate social distance in the gathering space
- Staggering work schedules to minimize the likelihood of physical contact on campus
- Avoid sharing workspaces; if not feasible, sanitize before and after each use
- Scheduling classes to minimize the likelihood of physical contact on campus (staggered class beginning and ending times, use of hybrid classes when possible)
- Adherence to ban on state travel

Practicing safe hand hygiene standards:

- Emphasis on the importance of regular and thorough handwashing
- Meeting accepted standards for continually and regularly cleaning, disinfecting and sanitizing campus
- Providing all persons on campus with convenient access to a sufficient supply of appropriate disinfectants (hand sanitizers and disinfectant wipes)

Implement Process for Supervisor Evaluation of Employee Job Duties and Unit Needs

Supervisors will evaluate employee job duties and unit needs to determine the employees needed to work on campus, review high risk employees, and identify employees whose job duties are suitable for telework, staggered schedules or other social distancing accommodations. [This paragraph revised as of 07/05/2020.]

Applying the above health and safety protocols, including social distancing practices, the unit heads will determine:

- Appropriate staffing levels
- Specific staff needed to perform unit functions
- Staff whose job functions can be performed via telework
- Physical modifications needed to the unit to accommodate increased staffing levels and service to students and the public
- Special modifications needed to the schedules and workspaces of high-risk employees whose jobs require on campus presence

Units will prepare their respective workspaces prior to the beginning of Fall Semester 2020.

Implement Procedures for Employees in High Risk Categories

High risk categories are defined by CDC. See **Attachment J**. Employees that self-identify being in a high-risk category and that their risk prevents them from returning to campus will be referred to EGSC Human Resources (HR). Employees may self-identify their high-risk status to their supervisor or HR. HR is responsible for following guidelines for disability requests and accommodations due to COVID-

19 high risk status. See *EEOC What You Should Know About COVID-19, the ADA, the Rehabilitation Act and Other EEO Laws*. **Attachment K**.

The process begins with HR conferring with the employee to determine whether the employee is in a high-risk category for COVID-19 as defined by CDC and reviewing the employee's desired accommodation. Documentation to substantiate the employee's high-risk status must be provided to HR. Documentation may be a treating physician's letter, a health insurance record or a current prescription for the high-risk condition. In limited instances where documentation is forthcoming, HR may, in consultation with the supervisor, grant a temporary accommodation for a defined period not to exceed 30 days. Following verification of the high-risk category by HR and review of the requested accommodation, HR will confer with the supervisor to determine whether an accommodation will minimize the risk and if feasible, grant the accommodation. In the alternative, the supervisor may allow the employee to continue teleworking. If an accommodation cannot be granted due to policy, HR will notify the employee. Employees whose requests have been denied may appeal to the President. [This paragraph revised as of 07/05/2020.]

Employees Who Care For or Live with Individuals at Higher Risk for Severe Illness from COVID-19

EGSC expects all employees, except approved high-risk individuals, to return to work as planned. Employees who care for or live with individuals at high risk for severe illness from COVID-19 should plan to return to campus as scheduled and work with their direct supervisor to ensure that their work environment allows for social distancing and the ability to practice behaviors known to reduce the spread of COVID-19. Employees living with individuals at high risk are encouraged to practice appropriate safe hygiene practices including those specific to the individual's high-risk condition. Employees in this situation may exercise appropriate leave provisions. [This paragraph revised as of 07/05/2020].

Emergency Paid Sick Leave and Extended Family Medical Leave

Any employee (as defined by the Fair Labor Standards Act) regardless of their length of service, is eligible for emergency sick leave if the employee is, in connection of COVID-19:

- (1) subject to a federal, state, or local quarantine or isolation order;
- (2) advised by a health care provider to self-quarantine;
- (3) experiencing symptoms and seeking a medical diagnosis;
- (4) caring for an individual who is subject to (1) or (2);
- (5) caring for a son or daughter whose school or child care provider is closed or unavailable; or
- (6) experiencing any similar condition specified by the U.S. Department of Health and Human Services.

The Family and Medical Leave Act is amended to allow employees with at least thirty days of service who are caring for a son or daughter under 18 years of age whose school or child-care provider is closed or unavailable due to COVID-19. Employees should contact HR for more information on the above policies. [This paragraph revised as of 07/05/2020].

Employee Assistance Program

Employees will be notified of the employee assistance program, KEPRO, which provides free and confidential counseling and support 24 hours a day, 7 days per week. Support is available to EGSC employees and eligible household members. Up to 4 free counseling sessions per issue, along with unlimited work/life support resources is available. Support services and information is available for a variety of areas such as: family support, alcohol/drugs, anxiety, managing stress, parenting, workplace, aging, depression, grief, abuse, work-life/convenience services, and legal and financial assistance. [This paragraph revised as of 07/05/2020.]

All Units Implement Health and Safety Preventive Measures

Prior to Fall Semester 2020 reopening, all EGSC units will need to be reconfigured for social distancing to ensure the health and safety of employees, students and the public. As mentioned earlier, Financial Aid, Library, Housing and Athletics areas were reconfigured to receive student visitors through the installation of physical barriers and acrylic shields, tape markings on floors to indicate social distancing and signage. A sample of the remaining units protocols is provided.

The Student Health Clinic will modify its practices to allow for visits by appointment only, social distancing in waiting areas, and offering tele-medicine appointments for symptomatic students. Students that are seen in the clinic will be screened (symptoms and temperature checks). See *Student Health Clinic COVID-19 Response Protocol – Fall Semester 2020*. **Attachment L**. Through cooperative agreements with GaSouU and AU, EGSC Statesboro students have access to the GSU Health Clinic where COVID-19 testing will be available and EGSC Augusta students have access to the AU Health Clinic where COVID-19 testing will be available. [This paragraph revised as of 07/05/2020].

The Counseling and Disabilities Services will modify its practices in a similar fashion. See *EGSC Counseling and Disability Services Tentative Plan for Counseling and Disability Services*, **Attachment M**. Dining Services will continue with mix of limited in person dining and boxed take-out meals. Housing plans are fluid and will develop per USG and Corvias guidelines.

EGSC contracts with a third party to provide bus service on weekends in Swainsboro for housing students and for EGSC Statesboro students transport to GaSouU campus; EGSC uses one transportation provider for these services. See *EGSC Bus Transportation Provider Safe Pledge*, **Attachment N**. [This paragraph revised as of 07/05/2020.]

To ensure adequate supplies and equipment are in place to implement the sanitation protocols, including employee responsibility for cleaning and disinfecting personal workspaces, hand sanitizer availability to all campus, adequate disinfectant, cleaning and sanitizing supplies for custodial staff, EGSC will purchase additional supplies and equipment.

Implement and Further Refine Plan for Testing and Screening of Employees

While current CDC and Georgia Department of Public Health (GDPH) workplace reopening guidelines recommend testing of employees where feasible, EGSC currently lacks resources to test its employees. Third party provider testing provided by USG to institutions would assist EGSC in this process. Beginning in Fall semester 2020, employees will be encouraged to self-monitor for symptoms of

COVID-19. A sample questionnaire from the Mayo Clinic illustrates COVID-19 symptoms. See *Mayo Clinic COVID-19 Self-Assessment Tool*. **Attachment F**. [This paragraph revised as of 07/05/2020.]

EGSC will follow CDC and GDPH guidelines for sending sick employees home and notifying EGSC Human Resources of this action. Employees will exercise personal responsibility to report symptoms to his/her supervisor and leave work when ill. EGSC will respond to suspected and confirmed cases of COVID-19 as indicated in the *EGSC Supervisor Guidance Regarding Employee Illness or Absence During COVID-19* (**Attachment G**). EGSC's COVID-19 Campus Contact will cooperate with GDPH and the local health departments when necessary concerning contact tracing. EGSC will comply with HIPPA regulations regarding confidentiality of an employee's medical records. [This paragraph revised as of 07/05/2020.]

“*What additional materials, supplies, equipment will be needed for staff to begin the fall semester of which you currently do not have access? Please use the attached template to document these items. “

Cleaning, disinfecting and sanitizing supplies and equipment and supplies and equipment necessary to reconfigure the remaining units and campus areas prior to Fall Semester 2020 that EGSC is unable to attain are noted on **Attachment O**.

“*Staff Development opportunities related to best practices in the remote work environment for job duties should be available as appropriate. Please provide a list of opportunities for staff development that are possible beyond your campus and accessible by other USG institutions without additional cost.

EGSC IT has provided training for staff on use of Zoom meetings and Adobe Sign has been implemented for document review and signing. EGSC will continue to research best practices and participate in training opportunities as they become available. [This paragraph revised as of 07/05/2020.]

Faculty

The gradual and staggered return to campus plans will inform the ultimate full return of faculty to the campus.

*Building on your plan for the gradual return, what additional actions will need to occur to ensure that the faculty on campus are prepared to start the fall semester as scheduled while also practicing social distancing? (Note: instructional expectations/plans will be addressed in the Academics & Research section).”

As mentioned previously for staff, prior to Fall semester start, education and awareness materials will be distributed to faculty and each faculty member will be instructed to acknowledge the health and safety protocols. Faculty leadership in this area is essential to the implementation success. Unit supervisors will enforce compliance with the health and safety protocols.

Faculty supervisors will follow the same evaluation process described for staff in determining the

schedules of faculty employees on campus and their location in determining the social distancing practices and health and safety protocols to be implemented. For example, faculty are required to wear a protective face covering as provided in the above USG directive, but not while in their personal office, provided the office is an enclosed area physically separate from others. Faculty should avoid clustering in hallways and breakrooms and are required to wear a protective face covering while in these areas. High risk employees identified will be offered telework if feasible; alternatively, the employee will be provided additional protections when in the workplace. Workspaces should not be shared, but if shared, should be sanitized before and after an employee uses the space.

Faculty supervisors will determine reconfiguring of unit spaces as needed to accept faculty, staff students and visitors while implementing social distancing and health and safety protocols. Physical barriers and acrylic shields will be used for this purpose as well as faculty-student meetings will not occur in faculty offices but will be held virtually, by telephone or at another on campus location where social distancing can occur. The unit heads will implement all necessary reconfigurations prior to Fall Semester 2020 start date.

Faculty supervisors will monitor faculty compliance with the health and safety protocols. [This paragraph revised as of 07/05/2020.]

EGSC will begin Fall Semester 2020 with all hybrid courses, allowing for a limited number of students on campus, and the ability to transition all courses to wholly online format if necessary. Classroom and lab spaces will be rearranged to ensure 6 feet between desks and workspaces. This is accomplished by removing desks, placing tape or other visible markers to outline a 6-foot radius, and physically placing barriers on chairs/desks that cannot be moved.

Faculty will monitor student absences and report absence peaks to his/ her Dean. Students absent for extended periods due to illness related to COVID-19 will be considered for possible online course transition if possible, hardship withdrawal or incomplete, as appropriate for the circumstances.

*“*What additional materials, supplies, equipment will be needed to begin the fall semester for faculty of which you currently do not have access? Please use the attached template to document these items.”*

Faculty workspace requirements are noted on the EGSC spreadsheet of needed resources. IT needs are noted on the academic affairs and IT plan incorporated herein. **See Attachment O.**

“Travel

Travel for faculty and staff in the USG will be guided by the up-to-date travel guidance from the CDC. Institutions will receive updated information as the situation changes. Faculty and staff who are traveling back to their campus from a region that is in the midst of a COVID-19 increase should follow the appropriate CDC guidelines related to self- quarantine. “

EGSC will continue to encourage use of its Travel Registry, a voluntary travel record of personal travel by employees and students.

CONTINGENCY PLAN # 2 – Fall classes begin fully online

EGSC will follow the transition plan to wholly online instruction plan implemented in Spring Semester 2020. Faculty are planning hybrid classes for Fall Semester 2020 with the flexibility to transition to wholly online as needed. No additional ramp up time would be needed for this transition. If this contingency plan should become necessary, classes will continue to be wholly online and no students will be in the on-campus residence halls. Employees access to campus will be limited and determined by job function. Teleworking plans will be implemented for non-essential faculty and staff. Visitors, including finalist applicants for employment, will not be allowed on campus; vendors will be allowed with permission.

Key elements of this plan are as follows:

- No access to campus is permitted by students or the public;
- Only essential employees are allowed on campus (during times specifically authorized by supervisor and approved by President). Essential employee lists are reviewed and updated weekly
 - Access to Swainsboro and Statesboro campus is strictly monitored by EGSC police;
 - EGSC Augusta employees at Galloway Hall on AU campus will follow AU campus access guidelines;
 - Each unit head will submit a weekly plan for essential employees to the President's Office on Friday of each week for the following week. That plan is provided to the Police Chief and access is strictly limited to authorized, essential employees.
- Enhanced regular cleaning/disinfecting/sanitizing of campus will be implemented;
- Supplies of hand sanitizer and disinfectant wipes will continue to be provided for all areas of campus;
- Social distancing while on campus will be required;
- All meetings will be required to be telephonic or electronic, when possible;
- Reporting and quarantining protocols established for sick employees/employees exposed to COVID-19 will be implemented;
- Food services are closed;
- Bookstore is closed (available online only);
- Student activity areas (including recreational and athletic facilities) are closed;
- Health center is open only for telephone consultation;
- Counseling and Disabilities will be open for telephone consultation or electronic meeting;
- Sudie A. Fulford Community Learning Center is closed;
- Voluntary Travel Registry will continue; and
- Travel ban will be place for all college-related travel.

Faculty will continue classes remotely through the D2L course management system. Student and academic support services will continue remotely as indicated above. In preparation for Fall Semester

2020, EGSC’s CARES Act proposal requests that funding be used to purchase laptops and hotspots for students in need, to equip classrooms for synchronous learning, webcams, Zoom licenses, and increase online tutoring services. If approved, the technological improvements, equipment and services will increase the likelihood of student success.

CONTINGENCY PLAN # 3 – Classes and operations must go to an online format for a period of time during the semester

“The USG will work in tandem with the Governor’s office, the Governor’s COVID-19 Task Force, and the Georgia Department of Public Health (GDPH) to make public health-informed decisions affecting the status of any of our campuses or our system.

Contingency plans 2 and 3 will require similar planning, in that classes and operations must be able to start or transition to an online, remote environment if the COVID-19 situation requires us to do so. Where noted, there will be different submission requirements based on the timing for any move to an online environment. Decisions about moving online will be made at the University System Office in consultation with the Governor’s office, the Governor’s COVID-19 Task Force, and GDPH. No institution shall make the decision to move online on their own.

Using the Spring Semester 2020 semester as a reflection point with lessons learned, institutions should implement best practices in the online delivery of courses and in the remote delivery of institutional services. These plans should include employees working remotely when possible and employees working on campus. Now is the time to conduct after actions reviews to identify opportunities for improvement in online delivery, as well as inventory the necessary resources that would be required to move to this environment again in the future.

*What preparations will your campus need to make to ensure a smooth transition to an online environment? Will there be additional ramp up time required? If so, how much?”

Fall Semester 2020 classes will be hybrid format with the clear intention that classes may transition to on- line at any time during the semester. Faculty are using lessons learned from Spring Semester 2020 transition and are preparing now for the hybrid format and possible online transition. No additional ramp up time is needed.

“Staff

*Institutions should document the work environment and expectations for all staff on campus to include:

- What policies and procedures need to be reviewed/amended to provide for a remote work environment, including new hire expectations?”

The following policies were implemented in response to COVID-19:

- EGSC Telework Terms and Conditions for COVID-19; (Attachment P)
EGSC Daily Telework Report; (Attachment Q)
- Emergency Paid Sick Leave; (Attachment R)
- Non-Closure Emergency Leave Procedures; (Attachment S)
- Non-Closure Emergency Leave Justification Form; (Attachment T)
- Supervisor Guidance for Employee Illness or Absence During COVID-19; (Attachment G) and
- Possible COVID-19 Exposure Report; (Attachment U).

The above policies remain in place and will be amended as circumstances require. As part of EGSC's budget reduction, open positions were eliminated. For critical positions that are approved and in process, the supervisor will evaluate the job function to determine whether on campus presence is required and suitability of the job functions for teleworking. Applicants will be informed of this by Human Resource, through the job posting, if at this initial stage, and if not, through supplemental written communication with the applicant. At this time, face to face meetings are required between HR and finalist applicant to verify and finalize employment documents. Appropriate protective measures and social distancing will be utilized by HR and the applicant.

- "Which employees are able to operate remotely? What are the supervisor expectations for these employees beyond the stated job duties?"

Using the procedure implemented in Spring Semester 2020, unit supervisors will identify employees that can work remotely and employees will be transitioned to telework. Supervisors will implement the Daily Telework Report procedure, requiring employees to report the tasks and goals completed, so that employees are held accountable for work assigned. Employees will be required to be available as needed for online meeting and phone calls, and flexible schedules may be implemented.

- "What additional equipment is necessary, if any, to move staff to telework?"

No additional equipment would be needed since this was addressed in Spring Semester 2020.

- "Which employees are required to remain on campus and should remain on campus and practice social distancing while still having student residence life operational?"

All residence staff should continue to work normal scheduled sufficient to cover needs of the resident population. This includes the director, assistant director, resident assistants, and housing safety assistant. The Student Health Clinic and Counseling and Disabilities Services will be required to continue to provide services on site while students are in the residence halls. Dining Hall staff will be required to continue to provide food service while students are in the residence halls and the bookstore will continue to operate. Campus law enforcement will remain on campus. Student Conduct and the Title IX Coordinator should be on campus and may consider alternating work schedules to ensure coverage in event of

student need. Library services and tutoring may be accessed online.

- “Which departments require personnel on campus for operations during specific times of the semester?”
 - Indicate departments that will require personnel on campus in the weeks leading up to the beginning of the semester and what the plans will be for practicing social distancing.”

Student support offices such as enrollment management (Financial Aid, Admissions, Registrar), Academic Center for Excellence (testing), Business Office, Library, and Athletics will require personnel on campus to serve students in the weeks leading up to Fall Semester 2020.

- “Indicate departments that will require personnel on campus at the beginning of the semester and what the plans will be for social distancing.”

Academic and student support offices mentioned above, as well as Student Conduct, Title IX, and Student Life will require personnel on campus at the beginning of the semester.

- “Indicate departments that will require personnel on campus at any other distinguishable time during the semester, including the timing.”

Personnel will need to be on campus to serve students during peak times: advising and registration periods (Academic Center for Excellence), add/drop periods (Registrar) and payment deadlines (Business Office).

In all of the above scenarios, social distancing will be accomplished through the use of physical barriers including acrylic screens separating the employee from the student/public, tape markings on the floor indicating 6 feet social distance, limiting the number of individuals in an office or area as needed for social distancing, signage, and students, guests and employees are required to wear protective face coverings as provided in the above USG directive.

- “What flexible schedules will be implemented to ensure social distancing is possible for employees who remain on campus?”

Unit heads will determine flexible schedules based on the needs of the unit and the employee’s job function. Work shifts should periodically alternate among employees so that each employee has the opportunity to work a desired late/early shift.

“Faculty

Using the existing academic structure on a campus, colleges/schools and departments should document the work environment and expectations for all faculty that fall outside of the traditional faculty expectations.

*What practices will be in place to ensure that faculty have access to their offices and other

necessary areas of campus while also allowing for the practice of social distancing and the safety of other essential personnel who may be on campus?”

Faculty supervisors will coordinate faculty office hours within the school for which each is responsible. Schedules will be communicated to each faculty member. EGSC’s education and awareness campaign will ensure that faculty receive the information necessary to practice social distancing and health and safety protocols. Signage will be placed in units reminding employees of these expectations. The importance of following the health and safety protocols will be stressed and an emphasis on personal responsibility for the health and safety of employees as well as the campus community will be communicated

“Travel

Travel for faculty and staff in the USG will be guided by the up-to-date travel guidance from the CDC. Institutions will receive updated information as the situation changes.”

Additional USG Guidance Concerning

Expectations for Testing, Screening, Contact Tracing, Isolation, and Notifications

“Every scenario/contingency plan should expect to implement the following:

At this point in time we do not know what our role in testing will be. In concert with GDPH, specific guidance from the USG will be forthcoming related to COVID-19 testing, monitoring, contact tracing, and isolating. Guidance related to testing, screening, contact tracing, isolation, and notifications is evolving and campuses should be flexible in their plans to be able to respond to the most up-to-date best practices.

For now, please submit the following information:

Testing

*In the event institutions will have access to rapid testing, will your campus be able to administer the tests through your on-campus health center or will you need to partner with a local health care provider or public health entity to administer tests? If you will need an external provider to administer tests, with which health care provider or public health entity in your community could provide this service? What additional resources would you need to provide access to testing outside of the tests themselves?”

EGSC’s on campus student health clinic is managed and staffed by a third-party provider and funded by student fees. The student health clinic provider is the local Swainsboro hospital, Emanuel Medical Center, which is a COVID-19 testing site. The clinic will screen students for COVID-19 symptoms tests students onsite. The clinic, in collaboration with the Georgia Department of Public Health will perform contact tracing, for those with positive test results. Students will be required to self-quarantine and must receive a “return to school” clearance from the healthcare provider prior to

return to classes. Students who are required to quarantine must work with faculty and VPASA to facilitate online learning during quarantine. Students who live on campus must follow student housing guidelines.[This paragraph revised as of 07/05/2020.]

Students at the EGSC Augusta campus, located on the AU Summerville campus, through cooperative agreement with AU, would have access to COVID-19 at AU. Students at the EGSC Statesboro campus, located near the GaSouU campus, through cooperative agreement with GaSouU will have access to COVID-19 testing at the GaSouU student health clinic.

Employees at all sites would be referred to their local healthcare provider for external testing or referred to the AU's screening and referral website and app. If all employees are to be tested prior to Fall Semester 2020 start, EGSC would make this requirement known to its employees with a timeline for completion prior to the start of Fall Semester 2020.

“Screening

**Institutions should develop and implement appropriate policies regarding screening, including temperature checks and/or symptom monitoring for employees and for students. Institutions will use guidance and best practices as outlined by GDPH. Please provide any policy or practice you will use to guide screening on your campus. What additional training or resources will you need in order to conduct the identified screening measures?”*

Beginning Fall semester 2020, employees will be asked to self-monitor for symptoms of COVID-19 and report illness to his/her supervisor. A sample questionnaire from the Mayo Clinic illustrates the COVID-19 symptoms. See *Mayo Clinic COVID-19 Self-Assessment Tool*. **Attachment F**. [This paragraph revised as of 07/05/2020.]

EGSC will follow CDC and GDPH guidelines for sending sick employees home and notifying EGSC Human Resources of this action. Employees will exercise personal responsibility to report symptoms to his/her supervisor and leave work when ill. EGSC will respond to suspected and confirmed cases of COVID-19 as indicated in the *EGSC Supervisor Guidance Regarding Employee Illness or Absence During COVID-19* (**Attachment G**). EGSC's COVID-19 Campus Contact will cooperate with GDPH and the local health departments when necessary concerning contact tracing. EGSC will comply with HIPPA regulations regarding confidentiality of an employee's medical records. [This paragraph revised as of 07/05/2020.]

“Contact Tracing

USG is working with GDPH to determine the best avenue for contact tracing on the USG campuses. Further guidance is forthcoming. Contact Tracing is an important part of an overall comprehensive approach. Additional requests related to campus planning for contact tracing and any necessary training will be given in the future. A plan submission is not required at this time.

Isolation

Employees who test positive or receive a clinical diagnosis for COVID-19 should leave campus immediately and not return to campus until they meet the below criteria for discontinuing home isolation. The Workplace and Health Safety plan should be followed and support the needs of the employee while away from work due to COVID-19.

Students who test positive for COVID-19 should leave campus immediately and return to their primary residence whenever possible. Students must remain off campus until they are able to meet the GDPH guidance for discontinuing isolation (see below).

*Institutions should submit their plans for:

- How to work with a student who tests positive for COVID-19 from the point of test results to allowing a student back on campus or back into campus life.”

When a student tests positive for COVID-19, the student will be instructed by the testing facility to quarantine. The student should notify the Vice President for Academic and Student Affairs (VPASA) of a positive test result and quarantine period. If the student lives in the residence halls, the student should notify his /her roommates and Housing Director to ensure adequate preventive measures for the roommates and the facility can be implemented. If possible, the student should be sent home for the quarantine period and the housing unit deep cleaned by EGSC per CDC guidelines. The VPASA will assist the student in contacting his/her instructors to notify them of absence period and to determine if learning can occur remotely. Faculty members should remain flexible and work with the student to the extent possible during this period. At the expiration of the quarantine period and when cleared by the student’s healthcare provider or student health clinic, the student may return to campus and to housing. EGSC will follow the GDPH Guidelines Concerning this topic.

GDPH Covid-19 Non-healthcare personnel Return to Work Guidance After COVID-19 Illness or Exposure – 5/21/2020, Attachment V.

- “Where a student will isolate if returning home is not an option
 - If in an on-campus residence hall, the residence life director will work in tandem with the campus health center or local health care partner to determine what practices and procedures should be in place. Plan submissions for this scenario should include details for those practices and procedures to include arrangements for cleaning and disinfections; food service; and monitoring. “

If a student must isolate in the on-campus residence hall because returning home is not an option, EGSC will, subject to availability, provide a unit for the student to live in isolation during the period of illness or quarantine. EGSC will reserve a limited number of units for this purpose. The student’s original unit will be deep cleaned per CDC guidelines. EGSC housing staff will deliver meals to the student using social distancing and conduct daily wellness check-ins with the student. See Housing

Plan for more details. [Paragraph revised 07/05/2020.]

- “If in an off-campus facility, describe where the student will go, what arrangements will need to be made with the off-campus facility, including expected cost (e.g. hotel, medical facility, etc.). Plan submissions for this scenario should include details for those practices and procedures to include arrangements for cleaning and disinfections; food service; and monitoring.”

EGSC does not provide off campus student housing. Students that test positive and live in off campus facility will be instructed to return home when possible, or quarantine in place. Students will be responsible for their own food, cleaning, and disinfecting. EGSC VPASA or designee will check on the student. Students will be required to provide a clearance letter from their healthcare provider to VPASA prior to return to campus. EGSC will follow the GDPH Guidelines Concerning this topic:

GDPH Covid-19 Non-healthcare personnel Return to Work Guidance After COVID-19 Illness or Exposure – 5/21/2020 Attachment V.

- “Plans should include any self-quarantine requirements as directed by the GDPH as a result of contact tracing.”

Students that are identified as having contact with a person infected with COVID-19 will be asked to self-quarantine by the local health department. The local health department conducts contract tracing for COVID-19 in conjunction with the college. The college and the student will follow the local health department’s instruction on quarantine. The student may return to campus upon clearance from the student health clinic or local health department. EGSC will follow the GDPH Guidelines Concerning this topic:

GDPH Covid-19 Non-healthcare personnel Return to Work Guidance After COVID-19 Illness or Exposure – 5/21/2020 (Attachment V).

Notifications

*Employees who test positive for COVID-19 or who receive a clinical diagnosis should report the positive test to their immediate supervisor as soon as possible. Each campus should identify one point person to whom all supervisors will immediately notify of an infected employee. This point person will initiate the institutional plan for contract tracing and any further notifications required with the GDPH. Supervisors are not to share the news of or the identity of a COVID-19 diagnosis/test with anyone other than the campus point person. Campus-wide notifications of COVID-19 are not necessary as long as contact tracing is in place.

*Students should notify the following individuals on campus if they receive a diagnosis of COVID-19:

If you live in the residence hall	Residence Director
If you live off campus	

If an employee receives a notification of a positive test for an employee or a student, they should immediately notify either their supervisor in the case of an employee or the VPASA in the case of a student.

If you live in the residence hall	VPASA and Residence Director
If you live off campus	Vice President for Academic and Student Affairs

Academic Arrangements for Faculty and Students with COVID-19

If a faculty member tests positive for COVID-19 or receives a clinical diagnosis for COVID-19 and is temporarily unable to continue teaching their courses, department chairs will make appropriate arrangements for the faculty member’s courses to be covered and for students to continue to earn the credit for which they are registered. Faculty will work with the campus human resources department to identify available leave options. “

Faculty may return to campus upon clearance from their healthcare provider.

“If a student tests positive for COVID-19 or receives a clinical diagnosis for COVID-19, faculty should be prepared to make any necessary flexible arrangements for a student to complete the coursework. The institution should make every effort to provide for continued enrollment for students with COVID-19 without penalty to the student. Students may choose to obtain a medical withdrawal for courses with a COVID-19 test or diagnosis.”

If a student chooses to return to campus, a clearance from their healthcare provider is required prior to return. EGSC will follow the GDPH Guidelines Concerning this topic:

GDPH Covid-19 Non-healthcare personnel Return to Work Guidance After COVID-19 Illness or Exposure – 5/21/2020 Attachment V.

2. Academics & Research

- Dr. Sandra Sharman, VP for Academic and Student Affairs (Chair)
- Jim Beall, Associate VP for Academic Affairs and Enrollment Management
- Dr. Carlos Cunha, Dean, School of Humanities and Social Sciences
- Dr. David Chevalier, Chair, Department of Biology
- Terri Brown, Director of eLearning
- Dr. Carmine Palumbo, Director of Study Abroad
- Dr. Da'mon Andrews, Assistant Professor of Mathematics
- Dr. Tommy Upchurch, Professor of History
- Courtney Joiner, Associate Professor of History
- Angela Storck, Director of Housing
- Nick Kelch, AVP for External Campuses/Director of EGSC-Augusta
- Jessica Williamson, Director of EGSC Statesboro
- Brandy Murphy, Coordinator of Dual Enrollment
- Karen Murphree, Director of the Learning Commons

The following is the plan of the Academic and Research Sub-committee:

[Entire section for Academics and Research replaced 7-11-2020]

CONTINGENCY PLAN #1 (Fall Classes Begin with Social Distancing Expectations)

Academic Instruction Plan for Re-Opening

Protective face coverings must be worn by students, faculty, staff and visitors inside all campus buildings as provided in the above USG directive. The exception to this rule is when faculty or staff are alone in their private offices.

Academic Instruction

The goal is to keep as much of a face-to-face experience intact while ensuring social distancing.

For courses and programs that were online prior to the system-wide move to online learning in March 2020, there is no expectation for changes to those courses and how they are or will be delivered.

Faculty who are scheduled to teach face-to-face or hybrid courses in fall 2020 shall not move their courses to fully online.

Faculty who fall into a higher risk population should contact EGSC HR to begin the process of requesting alternative arrangements for the fall 2020 semester. Faculty will work in tandem with their department chair/academic coordinator to identify the best alternate arrangement for delivering their courses. Faculty who are "at risk" will be allowed to be fully online. Those who are "at risk" but prefer to sign a waiver to be allowed to teach face-to-face may be able to do so.

Classroom Expectations

EGSC is planning to begin the Fall semester with a hybrid model of instruction to ensure social distancing is upheld. Course sections will be divided by instructional days to allow for social distancing in the classroom. The students will meet on alternating days, based on the scheduled weekly meetings. Example – A class that meets Monday/Wednesday will be split into a Monday section and Wednesday section that meets face-to-face once a week and remotely on the other. Synchronous online instruction will be conducted for the individuals that are learning remotely, as a result (class meets at same scheduled time, just remotely). The sharing of classroom supplies such as erasers, pens, or markers will no longer be allowed. Faculty will use their own supplies, which will be provided to them. It is expected that face protective face coverings will be used by all present.

To ensure safety, we will adapt spacing in hallways and common areas. During the time between classes, we will have faculty help students ease out of the rooms with distancing, before allowing students waiting in the hall to be let in with distancing. We will put tape spacers on the floors to mark where students will stand while they wait for a class to start and will mark hallways so there will be one-way directional markers to regulate the flow of individuals with social distancing (aligning with ADA guidelines for wheelchairs). The largest classroom in Swainsboro is C101 (seats 60 students) and in Statesboro, H196 (seats 80 students). Social distancing will work with the hybrid model. Students who are not in classes may congregate elsewhere on campus, so there will need to be monitoring and spacing in the library, coffee shop, rotunda, and other common spaces.

EGSC will adhere to all safety guidelines published by the USG. The College will use online resources to fulfill the requirements, specifically, for the pre-education students who will not go into the field for observations of live classes.

Instruction will occur in various formats: face-to-face in a hybrid setting, asynchronous, and synchronous. Funds from the CARES Act are being used to equip all classrooms on the main campus and the Statesboro instructional site with technology that will enable synchronous instruction to occur. Faculty will be taught to use this new technology prior to classes starting in mid-August.

When semester schedules are built and as classrooms are assigned, particular attention is paid to the specific requirements for instruction, faculty load, and space. For example, all ENGL 1101 classes (except online) are taught in computer labs. This is in direct response to the need for students to access word processing programs for daily writing, essay writing, and accessing online instructional materials. Another example of this detailed scheduling can be found in the social sciences classes, where group activities are encouraged. These classes are scheduled in the larger classrooms for ease of movement during group activities.

Faculty will begin returning to campus on the first day of classes. They will only come to campus on the days that they instruct face-to-face classes. Faculty will be expected to follow state and CDC guidelines for social distancing and keeping themselves and their environments sanitary. During breaks between classes, faculty will remain in their offices with the doors either slightly ajar or closed. All student consultations will occur remotely or by maintaining protective distancing. In this contingency plan, faculty will have robust and flexible office hours in an appropriate format to ensure students have the ability for one-on-one interactions with the faculty.

All faculty will also need the following technology (see table below):

Computer with high speed internet access (supplied by college)

Microsoft Office Suite (supplied by college)

Adobe Acrobat Reader or Adobe ProDC (supplied by college)

External storage device

Call forwarding enabled on office phones (supplied by college)

Smartphone

Zoom Pro Account (supplied by college)

USB Headphone Set w/Microphone

Webcam (supplied by college)

VPN access (supplied by college)

Faculty will need training related to hosting video-conferencing sessions (e.g. Zoom or Skype) and in creating, delivering, and managing online courses. The college has provided faculty with online instruction modules on how to teach online classes. The USG has also provided a variety of resources for successful online instruction. Faculty have 24/7 access to these development materials.

All part-time faculty will be required to complete online teaching instruction. The deadline for completion is September 15, 2020.

Many EGSC faculty are certified to teach eCore classes. The standards that are expected of eCore instructors are comprehensive. We formed our lists of Basic Expected Standards and Contingency Standards based on the eCore standards. The training modules that will be completed by faculty include: USG Online Faculty Development Series: Course One, Course Two, and Course Three. Full-time faculty have until August 5, 2020, to complete this training.

What faculty did to transition to fully online in spring 2020 can be done again with less effort this time since everyone now has experience doing it. Courses will already be set up in D2L to be totally online if necessary, and students will be informed of the possibility and logistics.

The faculty will have a list of “Basic Expected Standards” that are required for online instruction. All faculty must have these standards in place by the first day of classes. A second list, “Contingency Standards,” is a more comprehensive listing of standards that are required if instruction is transitioned to fully online.

The CETL Director and the Director of eLearning have communicated to faculty regarding online teaching resources, guidance, and training and are available for personal consultations with faculty. The

Deans will, also, arrange mentors for any faculty member who desires additional assistance in course design, delivery, and evaluation.

Faculty offices are currently arranged to appropriately enable social distancing. All full-time faculty have offices with doors that can be closed and locked. Since student consultations will be held remotely, the possibility of social distancing violations will be unlikely. Faculty will be expected to refrain from gathering in groups, sharing supplies, or participating in situations that are in violation of the social distancing policies set forth by the USG.

To enforce social distancing, desks will be positioned at 6-foot intervals. The desks between will be removed from the classrooms.

Laboratories are not currently arranged to appropriately enable social distancing, with the exception of the highest-level science classes that typically have a small number of students enrolled in them. The delivery of lab instruction will be a split or hybrid type where half the students attend on one day of laboratory and the other half receive online instruction. Laboratory materials will be cleaned and disinfected between uses. Students will be required to wear face protective face coverings, as provided in the above USG directive, and gloves during laboratory meetings.

Only faculty, administrative personnel, janitorial staff, emergency personnel, and student workers will have access to the faculty office suites. The suites will be accessible by key and will remain locked, at all times.

If faculty become ill, develop a fever, or suspect that they are becoming ill, they will remove themselves from campus immediately. They should be prepared to transition to online instruction for the duration of their illness. Faculty may not return to campus until 72 hours have passed with no symptoms and no medications to control for symptoms. Faculty must have written clearance from their physician before returning to work. Additionally, faculty may not return to work for at least seven days from the onset of their symptoms. Faculty will be expected to self-monitor for symptoms of illness. If faculty identify themselves as at-risk for infection of COVID-19, their teaching schedules will be amended to fully remote instruction.

Faculty have been informed of the appropriate steps to follow in case of illness.

To promote safety, classroom capacity has been re-configured for social distancing. The tables below illustrate these changes. Additionally, the auditorium will be available for small group meetings, tutoring sessions, and work meetings.

Academic Building Addition						
Room	Room Description	Capacity	Social Distancing Capacity	% of counted	Type of furniture	Notes
C101	Tiered Classroom	84	38	45	Fixed tables, pull out chairs	
C103	Biology Research Lab	16	8	50	Lab tables	
C108	Classroom	30	15	50	Chair/desk	

C110	Classroom	30	15	50	Chair/desk	
C112	Classroom	30	15	50	Chair/desk	
C114	Classroom	30	15	50	Chair/desk	
C115	Biology Lab	30	15	50	Lab tables	
C116	Classroom	30	15	50	Chair/desk	
C119	Biology Lab	30	15	50	Lab tables	

Academic Building						
Room	Room Description	Capacity	Social Distancing Capacity	% of counted	Type of furniture	Notes
C128	Activity Classroom	35	15	43		
C222	Chemistry Lab	24	10	42	Lab tables	
C223	Biology Lab	30	12	40	Lab tables	
C226	Computer Lab	31	14	45	Tables, moveable chairs	
C232	Biology Lab	30	12	40	Lab tables	
C233	Geology/Physics Lab	48	22	46	Fixed tables, moveable chairs	
C236	Computer Lab	24	12	50	Tables, moveable chairs	
C239	Classroom	46	20	43	Chair/desk	
C240	Classroom	46	20	43	Chair/desk	
C250	Classroom	33	15	45	Chair/desk	
C251	CETL	n/a				Used for resource storage and faculty access on an as-needed basis
C253	Classroom	34	15	44	Chair/desk	
C255	Classroom	34	15	44	Chair/desk	
C256	Office	n/a				
C257	Classroom	34	15	44	Chair/desk	

EGSC Statesboro Academic Facility

Room	Room Description	Capacity	Social Distancing Capacity	% of counted	Type of furniture	Notes
H132	Science classroom	29	15	52	Tables, moveable chairs	
H133	Computer classroom	30	15	50	Tables, moveable chairs	
H135	Computer classroom	30	15	50	Tables, moveable chairs	
H191	Classroom	35	16	46	Tables, moveable chairs	
H192	Office	n/a				
H193	Classroom	35	16	46	Chair/desk	
H194	Office	n/a				
H195	Classroom	40	20	50	Chair/desk	
H196	Classroom	35	16	46	Chair/desk	
H197	Classroom	40	20	50	Chair/desk	
H198	Classroom	35	16	46	Chair/desk	

Classroom Addition and Activity Center						
Room	Room Description	Capacity	Social Distancing Capacity	% of counted	Type of furniture	Notes
D130	Gymnasium	999	50	5	Open basketball court, walking track	Will be used for two aerobics classes; open-use at other times
D142	Computer classroom	20	10	50	Tables, moveable chairs	
D151	Art studio classroom	15	7	47	Tables, moveable chairs	
Luck Flanders Gambrell Center						
J503	Classroom	20	10	50		
J527	CHOICE	n/a				Office space
J528	CHOICE	n/a				Office space
J531	Computer	30	15	50		

	classroom				
J550	Auditorium	473	175	37	
EGSC Physical Education Building					
D101	Office	n/a			
D127	Computer classroom	30	15	50	
JAM Student Activities Center					
B112	Office	n/a			

The VPASA holds a weekly meeting for the deans, chairs, and coordinators. During these meetings, guidance and information from the USG, EGSC, and CDC are discussed and action plans are made in response to this information. The team, most recently, compiled correspondence for both faculty and students concerning what they need to know before the campus re-opens.

Academic Resources Required

Resource	Purpose	Cost
Webcams for classrooms and instructors	Effective instruction	\$80-\$120 for each classroom workstation (40 total)
Instructional supplies (white board markers, dry erasers)	Sharing of instructional supplies is prohibited	Varies by item
Sanitary supplies (hand sanitizing stations, disinfectant spray)	The work environment will be sanitized on a continual basis	Varies by item
Signage for Hygiene and Social Distancing Guidelines	Post signs in highly visible locations (e.g., school entrances, restrooms) that promote everyday protective measures and describe how to stop the spread of germs (such as by properly washing hands and properly wearing a cloth face covering image icon).	Varies by item
Computer with high-speed internet access	To deliver instruction efficiently	\$450
Microsoft Office Suite	To deliver instruction efficiently and effectively	No additional cost

Adobe Acrobat Reader or Adobe ProDC	To deliver instruction efficiently	No additional cost
Call forwarding enabled on office phones	To contact students when not present in office	No additional cost
Zoom Pro Account	To deliver instruction efficiently	IT has purchased these.
VPN access	To remotely access office computer	No additional cost

EGSC Momentum Year Plan for Re-Opening

EGSC will continue to actively participate in current Momentum Year Initiatives. To resume services for students, while allowing for social distancing, the EGSC must purchase IT equipment to maintain live contact with students. For example, the Director of Academic Support in the Residence Halls must have a computer camera and audio capability to continue to meet with students both singly and in groups. Also, to maintain the best practice of live tutoring, EGSC will use Tutor.com (\$24/hour) to provide access to tutors in every subject area 24/7 and continue to offer in-house tutoring in both face-to-face and virtual formats.

Presently, EGSC has planned creative ways to schedule the learning support components in the Academic Center for Excellence, using dedicated instructors. Peer tutors are available in the ACE and can be brought directly into the LS classrooms or be available virtually. EGSC is also working with the Dana Center to deliver a series of workshops to math faculty addressing learning challenges and pedagogy.

All summer orientations will occur remotely, so students who apply at later dates will have easy access to the orientation program. Because an interpretation and explanation of the results is very important, the Focus 2 Career Assessment that has been included in the orientation programs has been shifted to the FYE (CATS) classes. We will evaluate our current online orientation model and incorporate information directed at the utility and value of a college education.

All instructional support will be offered in either a face-to-face or a virtual mode. This includes supplemental instruction, peer tutoring, tutoring center, and writing centers. EGSC will offer both virtual (Tutor.com and face-to-face with in-house staff) and face-to-face (in ACE) tutoring for students (with appropriate social distancing measures). The student staff who monitor the entrances to the ACE will use a schedule with built-in increments (of 30 minutes) to schedule students for tutoring. Students will be informed of when they should return to the ACE for tutoring. This will be done to reduce congregating in the waiting areas. Drop-in or walk-in requests for tutoring will be discouraged.

Faculty training will be provided in future terms and incentives given to faculty to design and to embed Growth Mindset modules into their classes

Counseling services, individual and group sessions, will be offered in both face-to-face and virtual formats.

The table below outlines the current EGSC Momentum Year initiatives, what adjustments, if any, are

necessary for continuation of each initiative, and any alternate arrangements or technology needed for successful continuation.

EGSC Momentum Year Initiatives

Initiative		Adjustment Necessary (Yes or No)	Alternate Arrangement/ Technology Needed
1.	20% courses offered in 8-week format	No	
2.	Co-requisite courses in ENGL and MATH	No	
3.	Register students in 15-hours per semester	No	
4.	Students take 9-hours in focus area for first year	No	
5.	Focus 2 Career Assessment administered to all new students	No	
6.	Formal Mindset training in Critical and Academic Thinking Skills (CATS) course	No	
7.	New Student Orientation redesign	No	
8.	Appointment of Director of Retention and Retention Team	n/a	
9.	Early Alert System for students who are at-risk of failure	No	
10.	Director of Academic Support in Residence Halls	Yes	The Director of Academic Support in Residence Halls will need to transition to virtual meetings with students. This can be accomplished via telephone (Facetime), Skype, TEAMS, or Zoom. Both the Director and the students would need access to the internet, computer camera and audio capability, or a smart telephone.
11.	G2C course redesign in ENGL and MATH	No	
12.	Increased use of no and low-cost textbooks	No	
13.	Creation of 2 and 4-year academic plans for all majors	No	
14.	Tutor.com access 24/7	Yes	Additional hours of tutoring will need to be purchased from Tutor.com for \$24/hour.
15.	Mindset training for faculty	No	
16.	Faculty training for co-requisite	No	

	courses		
17.	Tutoring available in all subject areas in Academic Center for Excellence (ACE)	No	
18.	Academic Action Plan implemented to promote student ownership	Yes	This initiative requires face-to-face meetings with faculty advisors and with students' professors. With the continuation of social distancing, these meetings would need to occur via telephone conference call, Skype, TEAMS, or Zoom. Students and faculty advisors would need access to either working phones or internet.

EGSC Learning Commons Plan for Re-Opening

Academic Advisement

Contingency Plan 1 – Fall classes begin with social distancing expectations

How will academic support services be modified to minimize health risks?

It has been determined that the full-time academic advising staff do not have offices large enough to allow for proper social distancing of 6 feet or more between the advisor and the student.

It is suggested if social distancing is still needed and in practice in August, as anticipated, that we continue to advise or “see” students in virtually via phone calls, email consultations, Zoom meetings, etc. which was how advising and registration was conducted during the Spring 2020 fully online transition and will continue throughout Summer 2020.

GradesFirst campaigns will be created for students to sign up for their virtual appointments in the same manner as in person advising appointments.

The following best practices student’s comfort level

b. GradesFirst campaigns will be created for students to sign up for their appointments and asked to indicate in comments section if they want to meet in person or virtually. If virtually, list way they prefer to be contacted (phone, Zoom, etc.).

are suggested if academic advisors must meet with students in person.

a. Provide students the option to be advised either in person or virtually via, phone, email, Zoom, etc. depending on the

- c. If meeting is to take place in person, student and advisor would be required to wear protective face coverings as provided by the above USG directive for health and safety purposes.
- d. All offices should have hand sanitizer, air sanitizer (Lysol) and antibacterial wipes
- i. Office desk spaces should be wiped down after each student leaves advisor's office
- ii. Sneeze guard shields should be placed between each computer station in the Military Resource Center (Swainsboro) and on each study table. A work request has been submitted to have area measured for sneeze guards to be placed in the Center (cost still to be determined).
- e. Only 1 student allowed in advising session (no friends or groups or family members).
- f. Number of students in "waiting" areas (open Tutoring area, Military Resource Center, student study areas, open computer lab) need to be kept to a limited designated number
- g. Doors to "waiting" areas should be propped open as situations allow
- h. Based on symptoms presented by student, the advisor has the right to request the advising session take place by another mode (i.e. phone, email or Zoom).
- i. Somehow determine a way for advisors to have students take their temperature prior to entering advisor's office. If student has temp greater than 99 degrees, then student is not allowed to enter advisor's office and appointment will be conducted virtually or rescheduled.
- j. For registration periods, it is recommended that students be registered in the same manner as they were advised if social distancing is still needed and in practice during the registration period for fall. Advisors will register students virtually via phone calls, email consultations, Zoom meetings, etc. which follows the registration format that was utilized during the Spring 2020 fully online transition period and throughout Summer 2020.
2. What special initiatives will be launched to increase/maintain enrollments? (this information was requested as part of the Enrollment Management Committee Plan)
- a. Sending out regular communication to students through both personal and school email addresses as well as sending text messages via Mongoose when deemed appropriate. Also contact students by phone when needed.
- b. Continue responding to students within a reasonable time frame
- c. Create an incentive for students to register early for classes. It has been suggested several times to have students registered by credit hours, like GSU does. More hours completed earlier registration date.

Contingency Plan 2 – Fall classes begin fully online

All advisement and registration meetings will be conducted virtually via phone calls, email consultations, Zoom meetings, etc. in the same manner that advising, and registration was conducted during the Spring 2020 fully online transition period and throughout Summer 2020.

GradesFirst campaigns will be created for students to sign up for their virtual appointments in the same manner as in person advising appointments.

Contingency Plan 3 – Classes and operations must go to an online format for a period of time during the semester

The Academic Advising Staff would follow Plan 1 if the college is fully open at the start of the semester and then switch to Plan 2 if moved to fully online at some point during the semester.

Instructional Support

Swainsboro Academic Center for Excellence (A.C.E.)

Contingency Plan 1 – Fall classes begin with social distancing expectations

How will academic support services be modified to minimize health risks?

Social distancing and additional health measures will not affect traffic in the A.C.E. if A.C.E. Coordinators are present to manage the time constraints of student activities.

Implementing specific timespans and areas in which students can print, study, and be tutored will be essential to maintaining student traffic in the A.C.E. With these implementations, the A.C.E. will continue to function as a place where students can seek assistance in their courses.

1. Check-Ins

Having an A.C.E. Administrative Assistant (student worker) to serve as a desk attendant to monitor the check-in area will be very important moving forward for Fall 2020.

A work request has been submitted to have sign-in desk measured for Plexiglass shield to be placed around the desk.

The desk attendant will sign each student into the A.C.E. and inquire about student's purpose for coming to the A.C.E. (This will be expanded upon in the Social Distancing section).

The door, doorknob, and sign-in computer will need to receive periodic disinfection since these represent a high-traffic area subject to constant personal contact.

2. Social Distancing

Depending on the social distance requirements at time of opening, students may need to be directed to sit, or the space in the A.C.E may need to be modified to ensure that students sit, in such a way as to

maintain a specific distance from one another (currently suggested minimum of 6 feet). This will affect the number of students who can access A.C.E computers at any given time.

May need to move some computers from the current computer lab area of the A.C.E into the open study area to allow more distance between students.

previous concern for “safe computer access,” we need guidelines from IT as to what can be done to Time constraints may need to be created depending on the task the student is performing to ensure a smooth flow of traffic in the A.C.E. (The A.C.E. Coordinator can determine appropriate times for printing, studying, and tutoring, based on experience, etc., at a later date). A front-desk attendant will inquire about the student’s purpose in the space and allot the student a computer and timeframe in which the student can complete his or her task(s).

Group studying/tutoring may need to be regulated or conducted elsewhere.

3. Disinfection

The following supplies are needed to maintain a clean workspace:

- o Disinfectant spray and wipes
- o Protective face coverings for A.C.E. personnel and students accessing the A.C.E.
- o Sneeze guard shields should be placed between each computer station in the A.C.E and on each study table. A work request has been submitted to have area measured for sneeze guards to be placed in the Center (cost still to be determined).
- o Keyboard covers and mice covers have already been ordered (and purchased approved) for all computers in the Center. This will aid with being able to clean and disinfect work stations.

The A.C.E. will need to be “sprayed down” periodically

Consistent with the disinfect and protect their equipment (computers, keyboards, printers, etc.)

4. Tutoring

Depending on the social distancing being implemented, tutoring appointments will need to be scheduled online via GradesFirst or Catmail. Walk-in appointments will need to be monitored.

Additional tutoring sessions can take place over Zoom or Meeting Spaces if the student is unable to come in or does not feel comfortable with an in person tutoring session.

Tutors will need to be firmer when it comes to time limits on tutoring to ensure all students are accommodated.

5. Printing

Most printing is done via the library. This campus uses one printer. The Coordinator can manage the traffic for students without additional need for supplies.

Contingency Plan 2 – Fall classes begin fully online

All tutoring appointments will be conducted virtually via Zoom or Meeting Spaces through tutor.com in the same manner that tutoring was conducted during the Spring 2020 fully online transition period and throughout Summer 2020.

Students will be able to make appointments with tutors through Catmail or GradesFirst.

Contingency Plan 3 – Classes and operations must go to an online format for a period of time during the semester

The Swainsboro A.C.E would follow Plan 1 if the college is fully open at the start of the semester and then switch to Plan 2 if moved to fully online at some point during the semester.

Statesboro Academic Center for Excellence (A.C.E.)

Contingency Plan 1 – Fall classes begin with social distancing expectations

How will academic support services be modified to minimize health risks?

Social distancing and additional health measures will not affect traffic in the A.C.E. if the A.C.E. Coordinators are present to manage the time constraints of student activities.

Implementing specific timespans and areas in which students can print, study, and be tutored will be essential to maintaining student traffic in the A.C.E. With these implementations, the A.C.E. will continue to function as a place where students can seek assistance in their courses.

1. Check-Ins

Having an A.C.E. Administrative Assistant (student worker) to serve as a desk attendant to monitor the check-in area will be very important moving forward for Fall 2020.

A work request has been submitted to have sign-in desk measured for Plexiglass shield to be placed around the desk.

The desk attendant will sign the student into the A.C.E. and inquire about the student's purpose for coming to the A.C.E. (This will be expanded upon in the Social Distancing section).

The door, doorknob, and sign-in computer will need to receive periodic disinfection since these represent a high-traffic area subject to constant personal contact.

2. Social Distancing

Depending on the social distance requirements at time of opening, students may need to be directed to sit, or the space in the A.C.E may need to be modified to ensure that students sit, in such a way as to maintain a specific distance from one another (currently suggested minimum of 6 feet). This will affect the number of students who can access A.C.E. computers at any given time.

May need to remove some desks from the two workshop/teaching areas to maintain appropriate social distancing of 6 feet (middle rows in each teaching area).

May need to move some computers from current computer stations and create new computer stations in middle of room (this is pending IT limitations).

Time constraints may need to be created depending on the task the student is performing to ensure a smooth flow of traffic in the A.C.E. (The A.C.E. Coordinator can determine appropriate times for printing, studying, and tutoring, based on experience, etc., at a later date). A front-desk attendant will inquire about the student's purpose in the space and allot the student a computer and timeframe in which the student can complete his or her task(s).

Group studying/tutoring may need to be regulated or conducted elsewhere.

3. Disinfection

The following will need to be provided by the college to maintain a clean workspace:

- o Disinfectant spray and wipes.
- o Protective face coverings for A.C.E. personnel and students accessing the A.C.E.
- o Sneeze guard shields should be placed between each computer station in the A.C.E and on each study table. A work request has been submitted to have area measured for sneeze guards to be placed in the Center (cost still to be determined).
- o Keyboard covers and mice covers have already been ordered (and purchased approved) for all computers in the Center. This will aid with being able to clean and disinfect work stations.

The A.C.E. will need to be "sprayed down" periodically.

Consistent with the previous concern for "safe computer access," we need guidelines from IT as to what can be done to disinfect and protect their equipment (computers, keyboards, printers, etc.).

4. Tutoring

Depending on the social distancing being implemented, tutoring appointments may need to be scheduled online via GradesFirst and Catmail. Walk-in appointments will need to be monitored.

Additional tutoring sessions can take place over Zoom or Meeting Spaces if the student is unable to come in or does not feel comfortable with an in person tutoring session.

Tutors will need to be firmer when it comes to time limits on tutoring to ensure all students are accommodated.

5. Loans

In order to continue lending calculators and books, a protocol is needed for each activity.

Calculators:

- o All the hard-plastic slipcovers on calculators need to be removed and stored in the A.C.E.
- o A protective cover (say, a zip lock bag) is needed to minimize calculator contact by A.C.E. personnel and the students. The zip-lock bag will need to be taped around the calculators. After use, the bag can be disinfected.
- o Isolation boxes or containers (e.g., plastic shoe boxes) are needed to hold the individually returned calculators until they can be wiped down and returned to the overall inventory for use.

Books:

- o Similar to calculators, books, once used, would be placed by the student into an isolation box or container (e.g., a Rubbermaid bin big enough to hold our largest books), which would be sprayed in advance with a disinfectant, and the book would later be returned to the locked book cabinet.

6. Printing

One computer can be allocated specifically for printing only.

Once directed to the computer by the front-desk attendant, students can print their documents and then exit the Center. This will ensure a quick turnaround and maintain a steady traffic flow in the A.C.E. regarding students using printing services.

These computers will likely need to be disinfected often since they are the most used of all the other areas and equipment due to the high traffic rate.

If there are multiple students waiting for printing, they will need to form a cue outside in order not to fill up the A.C.E.

If possible, we need to shift to mobile printing (available through MyEGSC), where students could complete the sign in process from their personal computers (or phones). The student could remotely submit the document for printing from the A.C.E. printer, and then the student drops in to receive the printed document. without having to spend more physical time in the A.C.E.

Contingency Plan 2 – Fall classes begin fully online

All tutoring appointments will be conducted virtually via Zoom or Meeting Spaces through tutor.com in the same manner that tutoring was conducted during the Spring 2020 fully online transition period and throughout Summer 2020.

Students will be able to make appointments with tutors through Catmail or GradesFirst.

Contingency Plan 3 – Classes and operations must go to an online format for a period of time during the semester

The Statesboro A.C.E would follow Plan 1 if the college is fully open at the start of the semester and then switch to Plan 2 if moved to fully online at some point during the semester.

Augusta Academic Center for Excellence (A.C.E.)

Contingency Plan 1 – Fall classes begin with social distancing expectations

How will academic support services be modified to minimize health risks?

Social distancing and additional health measures will not affect traffic in the A.C.E. if A.C.E. Coordinator is present to manage the time constraints of student activities.

Implementing specific timespans and areas in which students can print, study, and be tutored will be essential to maintaining student traffic in the A.C.E. With these implementations, the A.C.E. will continue to function as a place where students can seek assistance in their courses.

1. Check-Ins

Having an A.C.E. Administrative Assistant (student worker) to serve as a kiosk attendant to monitor the check-in kiosk will be very important moving forward for Fall 2020.

A work request has been submitted to have sign-in desk measured for sneeze guard shield to be placed by check-in area.

The kiosk attendant will sign each student into the A.C.E. and inquire about student's purpose for coming into the A.C.E. (The importance of this position will be expanded upon in the Social Distancing section).

Having the attendant will cut down on the number of students accessing the check-in kiosk, decreasing the number of times the area will need to be disinfected.

The door, doorknob, and check-in kiosk will need to receive periodic disinfection due to it being a concentrated area of entry and exiting.

2. Social Distancing.

Depending on the distance requirements at time of opening (currently suggested minimum of 6 feet), students will be directed to sit in every other seat to maintain the specified social distance requirements.

Time constraints may need to be created depending on the task the student is performing to ensure a smooth flow of traffic in the A.C.E. (The A.C.E. Coordinator can determine appropriate timespans for printing, studying, and tutoring, based on experience, etc. at a later date). A kiosk attendant will inquire about the student's purpose in the space and allot the student a computer and timeframe in which the student can complete their task(s).

Group studying/tutoring may need to be conducted elsewhere due to space limitations and social distancing requirements.

3. Disinfection

The following will need to be provided by the college to maintain a clean workspace:

- o Disinfectant spray/wipes
- o Protective face coverings for A.C.E. personnel and students accessing the A.C.E.
- o Sneeze guard shields should be placed between each computer station in the A.C.E and on each study table. A work request has been submitted to have area measured for sneeze guards to be placed in the Center (cost still to be determined).
- o Keyboard covers and mice covers have already been ordered (and purchased approved) for all computers in the Center. This will aid with being able to clean and disinfect work stations.

The A.C.E. will need to be "sprayed down" periodically

Need guidelines from IT as far as what can be done to disinfect as well as cover their equipment (computers, keyboards, printers, etc.).

4. Tutoring/Testing

Depending on the social distancing being implemented, tutoring appointments will need to be scheduled online via GradesFirst or Catmail. Walk-in appointments will need to be monitored.

Additional tutoring sessions can take place over Zoom or through Meeting Spaces if the student is unable to come in or does not feel comfortable with an in person tutoring session.

Tutors will need to be firmer when it comes to time limits on tutoring to ensure all students are able to have their tutoring needs met.

Testing can be easily accommodated within our new "reality" with the following provisions:

- o The professors outline specific dates the students need to come test.

o The students contact the A.C.E Coordinator about what time they are available to come to the Center to test. (Walk-Ins must be discouraged to maintain social distancing guidelines).

o The A.C.E. Coordinator maintains a testing schedule that stays within social distancing guidelines.

During testing, minimal printing and studying can occur (space permitting) under complete silence. A sign can be posted on the door that will describe the rules that will be in place during test proctoring.

5. Printing

Two computers can be allocated specifically for printing.

Once directed to the computers by the kiosk attendant, students can print their documents off and exit the Center. This will ensure a quick turnaround and maintain a steady traffic flow in the A.C.E regarding students using printing services.

These computers will likely need to be disinfected often since they are the most used of all the other areas and equipment due to the high traffic rate.

If there are multiple students waiting for printing, they will need to form a cue outside the Center to not fill up the A.C.E.

If possible, we need to shift to mobile printing (available through MyEGSC), where students could complete the sign in process from their personal computers (or

phones). The student could remotely submit the document for printing from the A.C.E. printer, and then the student drops in to receive the printed document, without having to spend more physical time in the A.C.E.

Contingency Plan 2 – Fall classes begin fully online

All tutoring appointments will be conducted virtually via Zoom or Meeting Spaces through tutor.com in the same manner that tutoring was conducted during the Spring 2020 fully online transition period and throughout Summer 2020.

Students will be able to make appointments with tutors through Catmail or GradesFirst.

The Augusta ACE Coordinator would work with professors in utilizing online test proctoring services such as ProctorU or Examity to proctor tests as the center would be closed for testing.

Contingency Plan 3 – Classes and operations must go to an online format for a period of time during the semester

The Augusta A.C.E would follow Plan 1 if the college is fully open at the start of the semester and then switch to Plan 2 if moved to fully online at some point during the semester

Tutoring/Testing

Depending on the social distancing being implemented, tutoring appointments will need to be scheduled online via Catmail. Walk-in appointments will need to be monitored.

Additional tutoring sessions can take place over Zoom if the student is unable to come in. (Screensharing capabilities are available through Zoom).

Tutors will need to be firmer when it comes to time limits on tutoring to ensure all students are able to have their tutoring needs met.

It is imperative that the students can maintain relationships with ACE staff that are located on their respective campuses. Our staff members understand the quirks and intricacies of the Augusta Campus' faculty and classes. Depriving the student of this insight will leave the student inadequately prepared and possible lead to the student not being successful in a class they are struggling to pass.

Testing can be easily accommodated within our new "reality" if the following occurs:

The professors outline specific dates the students need to come test.

The students contact the ACE Coordinator about what time they can come test (Walk-Ins must be discouraged to maintain social distancing guidelines).

The ACE Coordinators maintain a testing schedule that stays within social distancing guidelines.

During testing, minimal printing and studying can occur (space permitting) under complete silence. A sign can be posted on the door that will describe the rules that take effect during test proctoring.

Printing

Two computers can be allocated specifically for printing.

Once directed to the computers by the kiosk attendant, students can print their documents off and be on their way. This is to ensure a quick turnaround and maintain a steady traffic flow in the ACE regarding students using printing services.

These computers will likely need to be disinfected the most out of all the other areas due to the high traffic rate.

If there are multiple students who are waiting to print, they will need to form a cue outside the ACE in accordance with social distancing guidelines.

If the printing function could shift to mobile printing (available through myEGSC) then students could complete the sign in process from their personal computers, have the document print from the ACE printer, and then the student drops in to receive the printed document without having to spend more physical time in the ACE.

Conclusion

Social distancing and additional health measures will not affect traffic in the ACE if ACE Coordinators are present to manage the time constraints of student activities. Our respective spaces are what we make of them; implementing specific timespans and areas in which students can print, study, and be tutored will be essential to maintaining student traffic in the ACE. With these implementations, the ACE will continue to function as a place where student can seek assistance in their courses.

Swainsboro Testing Center

Contingency Plan 1 – Fall classes begin with social distancing expectations

How will academic support services be modified to minimize health risks?

Due to the restrictive measurements of the ACE Testing Center, no more than 6 students should be testing simultaneously depending on social distancing requirements at the time of opening (current requirements 6 feet).

Limiting the number of students testing will require coordination with EGSC course instructors, particularly online instructors for whom the ACE provides proctoring services for most of the exams given throughout the semester.

Additional coordination will need to be done with the scheduling and proctoring of eCore exams conducted through the ACE Swainsboro.

The following best practices are suggested for the health and safety of students and ACE staff:

- a. Keyboard covers and mice covers have already been ordered (and purchased approved) for all computers in the Testing Center. This will aid with being able to clean and disinfect work stations.
- b. Sneeze guard shields should be placed between each computer station in the testing center. A work request has been submitted to have area measured for sneeze guards to be placed in the Testing Center (cost still to be determined).
- c. Throughout the work day, desks and computer equipment in the ACE Testing Center should be cleaned thoroughly before any student is permitted to test at a previously used station. This will require a dependable provision of cleaning supplies and sanitizers to ensure a proper cleaning and decontamination.
- d. Any student or faculty member not adhering to the policies prescribed by the ACE for the protection of the health of our students and staff should not be permitted to utilize our testing services.
- e. The test proctor should have the discretion to exclude students whose physical health clearly appears to be compromised. Those students will be asked to leave the Testing Center and reschedule their exams for another day.

Contingency Plan 2 – Fall classes begin fully online

The ACE Testing Coordinator would work with professors in utilizing online test proctoring services such as ProctorU or Examity to proctor tests as the center would be closed for testing.

Contingency Plan 3 – Classes and operations must go to an online format for a period of time during the semester

The Swainsboro Testing Center would follow Plan 1 if the college is fully open at the start of the semester and then switch to Plan 2 if moved to fully online at some point during the semester.

EGSC Study Abroad Plan for Re-Opening

Study Abroad recruiting programs typically occur over a six-month period. In normal circumstances, recruiting begins much sooner (e.g. students will often express interest in participating in Study Abroad a year or more before participating). The six-month time-period is necessary for students to obtain passports and possibly other travel documents, for Program Directors to make arrangements, including budgeting, scholarships, and logistics, and for appropriate academic planning and logistics to take place. EGSC has typically begun recruiting students for Study Abroad trips that take place during the spring and summer semesters during the previous fall semester.

EGSC has never undertaken a faculty led Study Abroad Program during the fall semester. Although it is possible that a student may participate in Study Abroad with another institution or a private organization during the fall semester, faculty-led programs and USG Goes Global programs have always run during the spring and summer semesters.

There are no faculty-led programs planned for the Fall Semester at EGSC, nor does USG Goes Global have any programs planned. As an institutional policy, Study Abroad should remain suspended through the Fall 2020 Semester, although recruiting for programs to run during 2021 should continue. If a student wanted to participate in Study Abroad with another institution or a private company, the institution would consider each request on a case-by-case basis.

The USG Study Abroad Handbook establishes that institutions may not offer programs to State Department Level 2 or higher or CDC Watch Level 2 or higher locations. EGSC should continue to adhere to this policy, with the provision that transit through airports and other countries may require further consideration.

We will not travel to any country that is designated by U.S. State Department at Level 2 or higher or CDC Watch Level 2 or higher.

Given that we will not travel to locations designated by U.S. State Department at Level 2 or higher or CDC Watch Level 2 or higher, there should be no need to quarantine returning participants,

faculty, staff, or students. If the situation changed during a Study Abroad trip (e.g. an outbreak of COVID-19), then the institution would strictly follow CDC guidelines regarding required quarantine periods for returning participants.

If employees or students do travel to places where COVID-19 is still active, then the institution should require that they self-quarantine, according to CDC guidelines.

Students who have been exposed to COVID-19 or who are coming from locations with higher rates of COVID-19 should self-quarantine according to CDC guidelines.

EGSC Research Plan for Re-Opening

Research is not required for a tenure-track faculty at EGSC. However, Biology faculty perform research with undergraduate students. The main locations for undergraduate research are the C103 and C115 labs on the EGSC Swainsboro campus. In addition, research is also conducted outside on the EGSC campus. Undergraduate research involves one Biology faculty and one student working together.

Both faculty and students will follow these guidelines while performing research on campus with social distancing:

Faculty will reserve the labs to perform research.

Only one Faculty and one student will perform research at the same time in the labs.

Faculty and students will be required to wear protective face coverings as provided in the above USG directive, and lab coats, at all times.

Faculty and students will remain 6 feet apart, at all times.

Faculty and students will, daily, disinfect benches, instruments, glassware, and any materials used during the research

A weekly schedule about the use of the research labs will be posted on the door of the research labs. Faculty will reserve the labs to perform research. Only one faculty and one student will perform research at the same time in the labs. Faculty will be responsible for the adherence to the schedule.

Currently, this plan provides that everyone, including faculty and students performing research, are required to wear protective face coverings, as provided in the above USG directive. EGSC will provide PPE for faculty and students performing research. Individuals who object to wearing protective face coverings due to a medical condition or religious objection will inform their supervisor and HR. HR and the employee will review and analyze possible accommodations and will coordinate with the supervisor to identify a solution. Central to the success of the implementation of EGSC's preventative measures is the personal responsibility of employees. Faculty and students performing research will be provided guidance on proper wearing of face coverings and how to make a face covering. See CDC Use of Cloth Face Coverings to Slow the Spread of COVID-19.

Instructions to follow while performing research will be posted on the door of the research labs and be given to faculty and students performing research. In addition, both faculty and students performing research will be asked to sign a statement that they received and understand these instructions. Faculty supervising the student research will be responsible for the adherence to these instructions. These instructions include: *Only one faculty and one student will perform research at the same time in the labs, *faculty and students will remain 6 feet apart, at all times, *no eating or drinking in the lab, and *faculty and students will be required to wear protective face coverings, as stated in the USG directive above, and lab coats, at all times.

A checklist of daily tasks to perform will be posted on the door of the research labs and be given to faculty and students performing research. In addition, both faculty and students performing research will be asked to sign a statement that they received and understand these tasks. Faculty supervising the student research will be responsible for the completion of these daily tasks. Thee daily tasks to perform at the conclusion of each research session include: *faculty and students will disinfect every bench that they use to perform research, *faculty and students will disinfect any equipment and materials used to perform research, and *faculty and students will thoroughly clean, with soap, glassware used to perform research.

Contingency Plan 2 – Fall classes begin fully online

“The USG will work in tandem with the Governor’s office, the Governor’s COVID-19 Task Force, and the Georgia Department of Public Health (GDPH) to make public health-informed decisions affecting the status of any of our campuses or our system.

Contingency plans 2 and 3 will require similar planning, in that classes and operations must be able to start or transition to an online, remote environment if the COVID-19 situation requires us to do so. Where noted, there will be different submission requirements based on the timing for any move to an online environment. Decisions about moving online will be made at the University System Office in consultation with the Governor’s office, the Governor’s COVID-19 Task Force, and GDPH. No institution shall make the decision to move online on their own.

Using the Spring Semester 2020 semester as a reflection point with lessons learned, institutions should implement best practices in the online delivery of courses and in the remote delivery of institutional services. These plans should include employees working remotely when possible and employees working on campus. Now is the time to conduct after actions reviews to identify opportunities for improvement in online delivery, as well as inventory the necessary resources that would be required to move to this environment again in the future.

*What preparations will your campus need to make to ensure a smooth transition to an online environment? Will there be additional ramp up time required? If so how much?

Academic Instruction

For courses and programs that were online prior to the system-wide move to online learning in March 2020, there is no expectation for changes to those courses and how they are or will be

delivered.

Faculty who are scheduled to teach face-to-face or hybrid courses in Fall Semester 2020 may have to move their courses to be delivered in a fully online environment if the COVID-19 situation calls for a temporary shelter in place or emergency declaration.

In this contingency plan, faculty should have robust and flexible office hours in an appropriate format to ensure students have the ability for one-on-one interactions with the faculty.

*What resources will be needed for the faculty to move to a fully online environment (fiscal, human, equipment, etc.)? Please note that there will not be additional budget dollars for these resources. This list is meant to identify what is needed so that the institution can begin to make arrangements. When possible, the USG will attempt to leverage the needs of campuses with the capacity at other campuses.

Resource	Purpose	Cost

For programs that require significant clinical, labs, and practicum experiences and where factors related to COVID-19 will prevent the completion of these requirements, institutions will work to develop alternatives and mitigate any impact on student progression whenever possible. Institutions will work with appropriate accrediting boards in developing appropriate alternatives where applicable.

Momentum Year & Momentum Approach/Student Success

COVID-19 has presented institutions with the need to be very flexible in their delivery of education. Critical to the success of students during this time will be comprehensive plans that are focused on supporting students for success. Momentum Year and Momentum Approach plans are in place or in development. Institutions must now reevaluate those plans to account for the need for flexibility.

*Using your existing Momentum Year and Momentum Approach plans the institution has already developed and begun implementing, identify any changes necessary to move to an online environment. Institutions should identify:

- Which initiatives need to be adjusted
- What alternate arrangements can be implemented
- What technology would need to implement alternate arrangements

*If not explicitly addressed in the revision to the Momentum Year/Momentum Approach items above, what revised practices for the following will be implemented in an online environment:

- Student advising model
- Instructional support (e.g. supplemental instructions, peer tutoring, tutoring centers, writing

- centers etc.)
- First Year Experience

*Please list any additional resources that are required to implement the above plans for Momentum activities, student advising, and instructional support.

International/Domestic Travel

Because the COVID-19 is an evolving situation, final decisions for any study abroad/study away programs for Fall Semester 2020 should be considered carefully and be informed by public health information. The USG will provide some baseline guidance to institutions related to study abroad/study away that will be based on the current public health information. If during the semester a student’s placement is affected by the need to move to an online environment at the home institution or the away institution, plans should be in place to allow for a student to complete the academic coursework in which they are enrolled when possible.

Faculty Development

*What quality measures will be in place to support the development of online courses and the ability to move quickly to and from remote instruction?

Academic Instruction Plan for Re-Opening

Faculty who are scheduled to teach face-to-face or hybrid courses in Fall Semester 2020 may have to move their courses to be delivered in a fully online environment if the COVID-19 situation calls for a temporary shelter in place or emergency declaration. There may be resources required for a move to wholly online instruction and the academic departments have outlined their requirements in the budget report that is attached. Fortunately, aside from the costs involved with outfitting faculty computers with cameras, the resources (see table below) needed for faculty require no fiscal expenditures.

Resource	Purpose	Cost
Online training for faculty to host video-conferencing sessions, module creation, flexible ways to deliver online instruction, evaluation and testing, and course utility.	The purpose of the training is to ensure that faculty are fully prepared to deliver course content to all students in ways that reflect best practices for online instruction.	Resources are available at no-cost.

If academic instruction is moved to a wholly online format, the faculty will be prepared to transition immediately. Faculty will be required to set up all their courses in D2L prior to the start of the semester (part-time faculty will be given two-weeks to set up their classes in D2L). This move is made in anticipation that classes will meet in a face-to-face format at the start of Fall Semester 2020; however, if classes are moved to an online format, EGSC faculty will be fully prepared to make a seamless move. Additionally, having learned lessons from the sudden transition

to online instruction in March 2020, the faculty have a much better understanding of what is required to teach fully online.

Synchronous online instruction will be strongly encouraged (class meets are scheduled time just remotely) for some faculty. Faculty choose their own delivery method for online instruction.

All faculty, full and part-time, will be required to complete an online training course during Summer Semester 2020.

Faculty who are at risk will conduct fully online instruction. Those who are at risk will be allowed to teach face-to-face classes, if they wish to, if they adhere to sanitary and social distancing guidelines.

All office consultations, club meetings, and advising meetings will be held in an online format, for the safety of faculty and students.

There will be no alterations to the course schedule.

Teacher education students, who, as an integral part of their program of study are required to spend time in elementary classrooms, will abide by the guidelines set forth by the participating school systems.

EGSC Momentum Year Plan for Online Instruction

All EGSC Momentum Year initiatives will be continued in the wholly online format. The technology needs will be, primarily, for students to have internet access and computers.

In a wholly online format, student advising will continue, with students making appointments and advisors working with students via telephone, Skype, or TEAMS.

All instructional support will be offered in a virtual mode. This includes supplemental instruction, peer tutoring, tutoring center, and writing centers.

There will no change to the First Year Experience, as it will be supported in an online format.

EGSC Academic Advisement and Instructional Support (all 3 locations)

All advisement and registration meetings will be conducted virtually via phone calls, email consultations, Zoom meetings, etc. in the same manner that advising, and registration was conducted during the Spring 2020 fully online transition period and throughout Summer 2020.

GradesFirst campaigns will be created for students to sign up for their virtual appointments in the same manner as in person advising appointments.

International/Domestic Travel Plan for Online Instruction

EGSC will continue follow guidance from the CDC and the U.S. Department of State to stay informed regarding current status of COVID-19 infection in locations, both domestically and abroad, and will leverage university system resources, including guidance from the USG Office of International Education, to make decisions dealing with Study Abroad and Study Away programs. At no time will travel be approved to locations designated as Level 2 or above by the Department of State or the CDC.

EGSC Research Plan for Online Instruction

Research on campus will be suspended when instruction is switched fully online. Undergraduate students will continue their research from home by analyzing results and writing research articles.

CONTINGENCY PLAN #3 – Classes and operations must go to an online format for a period of time during the semester

If this contingency occurs, EGSC will follow the same process as followed in Spring Semester 2020 when all USG institutions were directed to move to a wholly online format.

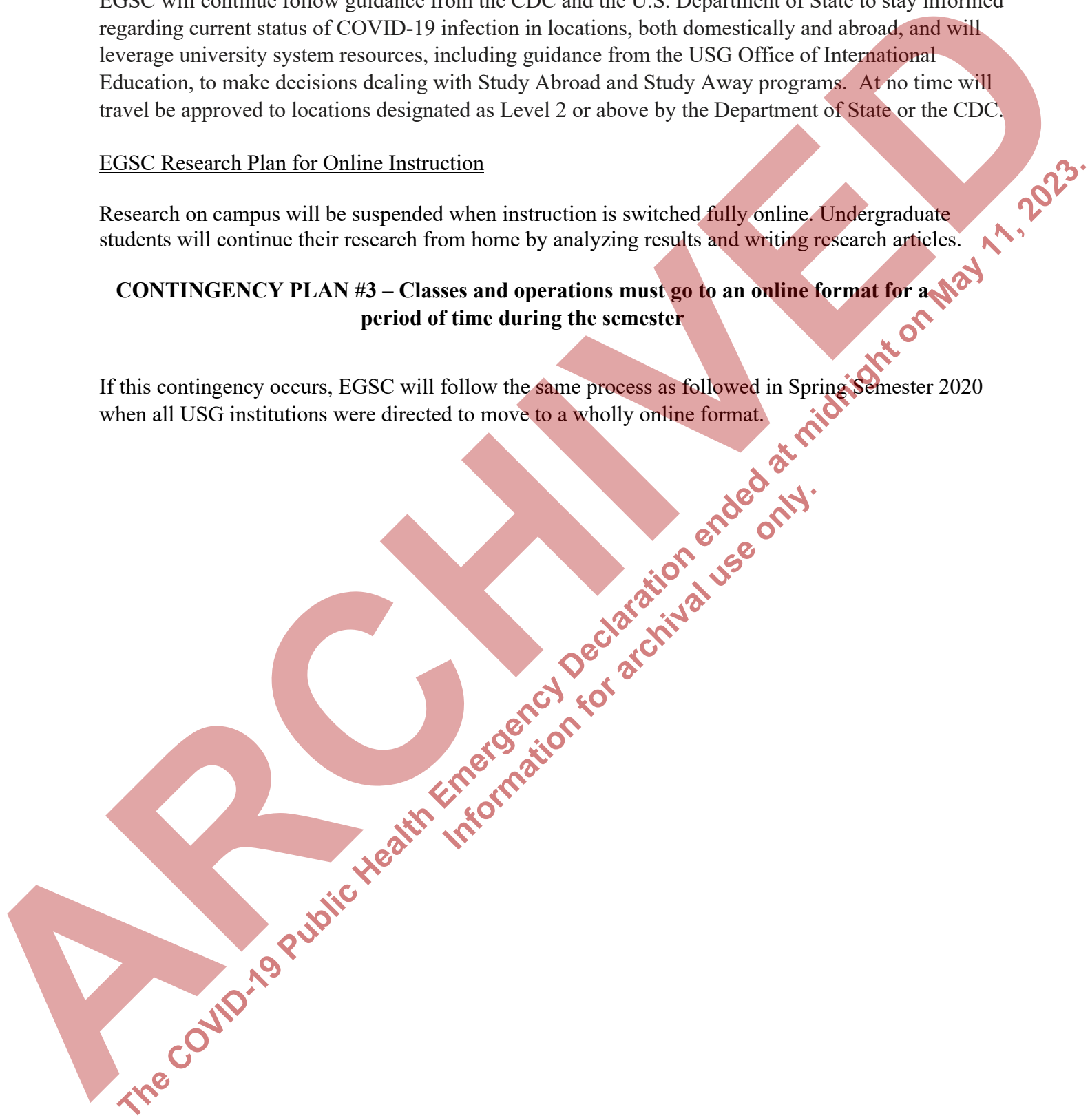

3. Public Service, Outreach, Continuing Education & Cooperative Extension

- Angie Williams, Director of Event Planning and Scheduling (Chair)
- Jean Schwabe, Director of the Fulford Center

The following is the plan of the Public Service Sub-committee:

CONTINGENCY PLAN# 1 – Fall classes begin with social distancing expectations

Guiding Principles

As we all work together to mitigate the impact of COVID-19 and to move toward a Fall Semester 2020 return to campus, we are also focusing our top priority on how we can monitor and protect the health and safety of our EGSC community, both internal and external, to each of our three campuses. In order to provide the faculty, staff, students, and members of the community a sense of security, confidence, and continuity with our “new normal” that any area they may visit is safe and sanitary, we will have to remain flexible and be well prepared to respond strategically to the possibility of constant changes. In formulating the most comprehensive plan possible, we have followed the guiding principles, best practices, and directives as set forth by the USG, GDPH, and the Governor’s office. However, in making critical decisions to allow certain college activities and community meetings/events to once again start taking place on our campuses, it is incumbent upon us to create and maintain a healthy and safe environment, be intentional with having faculty, staff, students, and community accept personal responsibility for their own health and safety as well as for others, and to provide the essential educational tools to our audience for this plan to be successful.

Action Steps

To carry out this plan, it will be necessary to identify the recurring activities, programs, meetings, and events held during Fall Semester 2020 and if they are internal or external to the college. Next, it will be key to examine all locations on the Swainsboro campus inclusive of the Fulford Center as well as the Statesboro campus to determine which of these programs, meetings, and/or events we will be able to allow to take place, in which building, in which room, and how many individuals the room will be able to accommodate at a time. Additionally, consideration for the layout of the room will be required to allow for the limited social distancing expectations. This will determine the maximum number of occupants that can be allowed in that location therefore permitting us to make well informed decisions about scheduling meetings/events. To further ensure the health and well-being of the participants, the identification of essential supplies and signage required in each area being utilized for a specific event will be another important step. The Augusta campus, which is in Galloway Hall on the Summerville Campus of AU, will follow AU approved guidelines by the USG.

Primary responsibility and timeline for Action Steps

The primary responsibility for ensuring that each of the action steps are completed belongs to the EGSC unit Institutional Advancement/Event Planning and Scheduling. The anticipated completion timeline is July 1, 2020.

**Education of the EGSC community about this Public Service Component of this Plan
(note: the communications plan below should address the communication techniques which will be used)**

Regular and factual communication will be key to maintaining successful activities and events on campus, as well as ensuring a safe, healthy environment. Local and area newspapers, social media, as well as the EGSC website will be utilized as the primary source of information sharing. Constant communication with the faculty, staff, students, and community will allow us to share information about campus events and if they will be postponed or cancelled. Regular updates with the community will also keep them informed about what is happening on our campus and with our students. In addition, groups that wish to utilize campus facilities will receive, via email, specific information related to their visit which align with the USG, GDPH and the Governor's Office current expectations and social distancing guidelines. Relevant informational and educational items will include measures the college has implemented to address social distancing guidelines, including the requirement of all faculty, staff, students, and visitors to wear an appropriate face covering while inside campus facilities/buildings where six feet social distancing may not always be possible, as well as the CDC guidelines for hygiene best practices in an effort to protect all EGSC faculty, staff, students, and community visitors, particularly those who may fall into the high risk category, to any of our three campuses. It will be vitally important for everyone to understand through appropriate communication face covering use will be in addition to and is **not** a substitute for social distancing.

See also the Communications Sub-committee section of this plan below.
[Section revised 7-11-2020]

Scheduling of College Activities at the Fulford Center during Fall Semester 2020

The Fulford Center plans to resume college activities as well as allowing external parties to schedule programs, meetings and events during Fall Semester 2020 by strictly adhering to the EGSC standards that have been implemented and by following the guiding principles established by the USG, GDPH and the Governor's Office. Historically, the Fulford Center has allowed multiple meetings/events to occur during a single day. It will now be open to only one group at a time per day. As has been the practice in the past, anyone who would like to reserve the Center for a meeting/event will contact the Fulford Center Director. The director will continue to take reservations in this manner. To comply with the current protocols, the planetarium will be closed due to the impossibility of social distancing, limited or otherwise. The Center classroom will be the most utilized space although the entire building will be available for use. It will be the responsibility of the director when accepting reservations to ensure the visitors understand face covering use will be in addition to and is **not** a substitute for social distancing. As weather permits, the deck will also be utilized as needed. When outside where social distancing can be observed, face coverings will not be required.

The standards that will apply regarding the size of meetings/events will be based on limited social distancing expectations, including the requirement of all faculty, staff, students, and visitors to wear an appropriate face covering while inside the Fulford Center where six feet social distancing may not always be possible, the CDC guidelines for hygiene best practices, cleaning and disinfecting between groups, the type of program/meeting requested, availability of space utilizing the standards to

accommodate. Due to the necessity of reducing the number of groups to one per day, the Center may not always be able to accommodate a group on a specific day or time. In those instances, the Event Planner will be contacted to determine the availability of an appropriate room in one of our other buildings on campus that has been identified as a space where programs/events can be held.

[Above paragraph revised 7-11-2020]

Plan for Activities of MMGYSTC during Fall Semester 2020

The activities of MMGYSTC will be carried out during Fall Semester 2020 by the MMGYSTC Coordinator and her assistant. All activities will be conducted in the member school districts by the coordinator and her assistant. The assumption is the schools within the member districts will be re-opened. In addition, the MMGYSTC Coordinator and assistant will provide virtual professional development opportunities to member school districts as needed. GYSTC will supply the coordinator and her assistant the necessary PPE for use during school visits. When not conducting activities in the schools, the coordinator and her assistant will maintain a shared office space at the Fulford Center. The square footage of the existing office space they occupy will only allow for limited social distancing expectations when both are scheduled to work in the office simultaneously. Otherwise, they may consider a staggered work schedule. While working at the Fulford Center, the coordinator and her assistant will be expected to provide their own protective face covering or cloth face covering; however, hand sanitizers and disinfecting supplies will be available for their use.

Plan for Activities at the Morgan House during Fall Semester 2020

It is not possible for events to be safely scheduled for the Fall Semester 2020. It would be a formidable task to allow any events to take place and remain in compliance with the guidelines of the USG, GDPH, and the Governor's office, even if some exceptions could potentially apply through limited social distancing protocols. *Therefore, there will be no activities scheduled for the Morgan House during the Fall Semester 2020 semester.*

Plan for Scheduling events by External Parties during Fall Semester 2020 in Other Campus Facilities

(e.g., visits to campus by grade and high schools, scheduling of events in campus facilities such as the Gambrell Center, SAT testing)?

The method for allowing external parties to schedule events during Fall Semester 2020 in other campus facilities will entail many of the same processes that we have employed in the past. In preparation to make rational, health-informed decisions regarding the scheduling of groups, whether internal or external to the college, we had to begin with action steps. In determining the requisite action steps and the timeline for the development of the comprehensive plan based on our findings, we have determined that external parties should be allowed to schedule meetings/events in several campus facilities. The

group size in most cases will be extremely limited. The external parties will continue to go through the Event Planner to reserve the location for their meeting/event. The Event Planner will create a Facilities License Agreement that will be modified by working with our legal counsel to include the EGSC protocols regarding social distancing standards, the requirement of all faculty, staff, students, and visitors to wear an appropriate face covering while inside campus facilities/buildings where six feet social distancing may not always be possible, best practices, and directives developed in compliance with the USG, GPHD, and the Governor's Office. Additionally, the requirement of Liability Insurance will continue to be applied, as well as any fee changes that may occur.

Because larger events such as conferences, sporting events, assemblies, etc. can contribute to the spread of COVID_19, sizable gatherings of individuals numbering more than 50 may not be accommodated at this time even with limited social distancing expectations in place.

[Above paragraph revised 7-11-2020]

The USG will work in tandem with the Governor's office, the Governor's COVID-19 Task Force, and the Georgia Department of Public Health (GDPH) to make public health-informed decisions affecting the status of any of our campuses or our system.

Contingency plans 2 and 3 will require similar planning, in that classes and operations must be able to start or transition to an online, remote environment if the COVID-19 situation requires us to do so. Where noted, there will be different submission requirements based on the timing for any move to an online environment. Decisions about moving online will be made at the University System Office in consultation with the Governor's office, the Governor's COVID-19 Task Force, and GDPH. No institution shall make the decision to move online on their own.

Using the Spring Semester 2020 semester as a reflection point with lessons learned, institutions should implement best practices in the online delivery of courses and in the remote delivery of institutional services. These plans should include employees working remotely when possible and employees working on campus. Now is the time to conduct after actions reviews to identify opportunities for improvement in online delivery, as well as inventory the necessary resources that would be required to move to this environment again in the future.

*What preparations will your campus need to make to ensure a smooth transition to an online environment? Will there be additional ramp up time required? If so, how much?

Because EGSC does not offer Continuing Education Classes or Cooperative Extension which would potentially fall into the category of transitioning to an online environment, the same preparations that Academic Instruction would have to enlist, would not be applicable to the Public Service and Outreach Programs that we provide to the community. Should the need arise to transition to an online environment, we will immediately cancel all activities, programs, meetings, and events scheduled for any of our campuses. No additional ramp up time will be required to accomplish this task.

Each institution should identify all of the activities and programs that fall within the categories of public service, outreach, continuing education, and cooperative extension. For each activity or

program, there should be a comprehensive plan in place to either move to a fully online environment or cancel activities. Activities related to public service, outreach, continuing education, and cooperative extension will follow the guidelines of the institution related to the cancellation of activities and events, as well as the remote work environment. Because these activities vary widely across institutions, it is not expected that each institution submit a plan to the USG for the continuance of these activities; however, it is expected that institutions make public health-informed decisions that are appropriate and in alignment with USG, GDPH, and the Governor's office guidance and directives.

Decisions related to external events scheduled on our campuses should conform to the current campus status and be in alignment with USG, GDPH, and the Governor's office guidance and directives. In the event a campus must move to a remote online environment, institutions may need to cancel other campus activities. Campuses should work with their legal counsel or the USG legal counsel as necessary to cancel any contracts. Institutions should attempt to reschedule events whenever possible. For events that are unable to occur, credit should be offered for a future event or a refund should be provided. Institutions should develop a set of published expectations for outside events being held on campus that reflect the requirements for the campus operations.

Major events on campus such as Homecoming and student preview days are expected to follow the up-to-date social distancing requirements.

*Institutions should develop a process to determine which activities and events should be cancelled when a move to online instruction is needed and which activities may continue.

If the situation changes and online instruction is needed, the following process should occur as they relate to programs, activities, meetings, or events that are scheduled:

- All activities, programs, meetings, events will be postponed or cancelled when a move to online instruction is needed.
 - All parties with reservations will be contacted immediately via telephone followed up with an email requesting a written reply of preference to re-schedule or cancel.
 - If the external party has entered into a signed agreement with EGSC and paid any monies, then the agreement will become null and void and any refundable monies will be returned to the permit holder if they choose to cancel.
 - Contact should be made with the Marketing and Communications staff to create a press release to go out immediately to all local & area newspapers.
 - The EGSC Website will be utilized to provide updates. All social media outlets should be updated to reflect the postponement or cancellation of all activities and why with the appropriate contact information for questions.
- Continued weekly updates through the formats listed to faculty, staff, students, & community.

Contingency Plan 2 – Fall Semester 2020 classes begin fully online

There will be no need for the development of a compliance plan if Fall Semester 2020 classes begin fully online. Should this become a reality and there are no students on campus with only essential personnel allowed, we will not be scheduling any meetings/events internal or external to the college on any of our three campuses. However, we will assume a virtual format for special programs such as Fall

2020 Faculty & Staff Workshop and Convocation, and special major events such as Graduation.

Contingency Plan 3 – Classes and operations must go to an online format for a period of time during the semester

The plan in place for limited and full social distancing will be suspended for the period during the semester that the classes and operations must transition to an online format. During the time of suspension, all scheduled events will be postponed or cancelled, and all external parties will be contacted immediately. If the external party has entered into a signed agreement with EGSC and paid any monies, then the agreement will become null and void and any refundable monies will be returned to the permit holder. All parties will be given the opportunity to be notified and to re-schedule should they so desire once the fully online classes are suspended and “normal” operations resume. Any college activity such as Graduation that will need to be celebrated and observed will be held virtually.



4. Student Life

- Sandra Sharman, VP for Academic and Student Affairs (Chair)
- Karen Jones, AVP for Student Affairs
- Stacey Grant, Director of Student Life
- Veronica Cheers, Coordinator of Student Life
- Angela Storck, Director of Housing
- Ruth Underwood, Director of Dining Operations

The following is the plan of the Student Life Sub-committee:

CONTINGENCY PLAN #1 (Fall Semester 2020 Classes Begin with Social Distancing Expectations)

“Institutions should seek to offer a student life that resembles a traditional student experience whenever possible. Social distancing will undoubtedly change the nature of the type of events, activities, experiences that can be provided. The goal is to connect students to the institution in a manner that promotes student success and engagement.

Residence Life

life is a critical component to many students’ experience at our institutions and should be preserved as much as possible. Institutions will not be able to guarantee the safety from COVID-19 to residential students.

Residence hall rooms will be viewed as a shared residence within each room or suite, similar to a family’s shared residence in that social distancing practices are not expected within the room or suite. As such, it is the responsibility of the residential students to adhere to appropriate behaviors related to the prevention of COVID-19, including the cleaning of their room or suite. Individual students should be reminded of the best practices in prevention but must take responsibility for their own actions.

Institutions will create an environment in which students can practice the safety guidance adapted from the CDC in the public areas of the residence halls. Individuals are responsible for the cleaning and disinfection of their individual room. Guidelines for individuals living in shared housing include:

Protect Yourself:

- Social distance by staying at least 6 feet apart from others that you do not live with.
- Consider wearing cloth face coverings in any shared spaces, not including your room.
- Everyday preventative actions everyone should take:
 - Know how it spreads
 - Wash your hands often
 - Avoid close contact
 - Cover your mouth and nose with a cloth face cover when around others

- Cover coughs and sneezes
- Clean and disinfect

Know where to get information

- Make sure you know how your residence hall is going to communicate COVID-19 information to you; email, websites, hotlines, automated text messaging, newsletters, and flyers to help communicate information on.

The Residence Hall

- COVID-19 prevention supplies should be provided in common areas, such as soap, alcohol-based hand sanitizers that contain at least 60% alcohol, tissues, and trash baskets. Custodial staff will be responsible for the cleaning and disinfection of the common areas.
- Non-essential volunteers and visitors in shared areas should be limited or avoided.
- Staff should avoid entering residents' rooms or living quarters unless it is necessary. Staff should use virtual communications and check-ins (phone or video chat), as appropriate.

Common Spaces

Be flexible, rules may change in common areas. Maintain 6 feet of social (physical) distance between yourself and everyone that you do not live with. This may mean there will be alternatives to activities, cancelled activities, or closed areas. If you see people in areas that are small like, stairwells and elevators, consider going one time. Here are some examples of how the rules in common spaces may change:

Shared kitchens, dining rooms, laundry rooms, bathrooms

- Access should be available, but the number of people should be restricted so that everyone can stay at least 6 feet apart from one another.
- People who are sick, their roommates, and those who have higher risk of severe illness from COVID-19 should eat or be fed in their room, if possible.
- Do not share dishes, drinking glasses, cups, or eating utensils. Non-disposable food service items used should be handled with gloves and washed with dish soap and hot water or in a dishwasher.
- Guidelines for doing laundry such as washing instructions and handling of dirty laundry should be posted.
- Sinks could be an infection source and should avoid placing toothbrushes directly on counter surfaces.

Totes can be used for personal items so they do not touch the bathroom countertop.

Students who are considered to be at a higher risk for severe illness as defined by GDPH should carefully consider whether moving into a residence hall is the appropriate option.

Returning to the residence halls will be a significant undertaking. Each campus has unique residence hall configurations and thus it is difficult to provide standard expectations. Plans for residence life should be built on the following ideas:

- Student safety is the top priority.

- Residence life is a crucial component for many students in their academic experience.
- Students ultimately will make their own choices. Our goal is to provide a safe environment for living that allows for social distancing.

*Institutions should submit plans for the following:

- An acknowledgement form for students listing the best practices known at the time of move-in should be developed and used for each resident.
- Each institution should develop an awareness campaign for the residence halls to promote best practices in prevention.
- Policies or practices that may need to be amended to accommodate high risk students (e.g. amending requirement for new students to live on campus during their first year)
- Sanitation practices/procedures
- Bathroom access/accommodations for various types of halls (community bathroom vs. single occupancy vs. double occupancy)
- Policies/Rules related to the residence halls that will need to be in place during the fall
- COVID-19 prevention supplies that will be provided in common areas, such as soap, alcohol-based hand sanitizers that contain at least 60% alcohol, tissues, trash baskets, and, if possible, cloth face coverings that are washed or discarded after each use.
- Visitation policy changes
- Reduction of residence hall staff visits to residents' rooms or living quarters unless it is necessary. Staff should use virtual communications and check ins (phone or video chat), as appropriate
- Additional resources needed

* Institutions should use their move-out plans from the Spring Semester 2020 and the lessons learned to develop a plan to move students back into the residence halls while allowing for the practice of social distancing.

Residence Life

**Per USG guidance, Contingency 2 and 3 will follow the same guidelines as Contingency 1 for Housing unless gubernatorial guidance dictates otherwise. Students will be advised that policies may be updated at any time to reflect this guidance and that compliance with new policies is required.*

***A limited social distancing policy in housing would follow Contingency 1-3 plans with the exception that outside visitors may be permitted to visit the residence halls under limited social distancing expectations. All other policies would remain in place until the social distancing guideline has been fully rescinded.*

Objective	Action Steps	Responsible Dept/Unit	Timeline for Completion
Communication Plan	<p>Create a series of email correspondence that will be disseminated during the summer and into the fall semester that will update/inform about changes in COVID status and guidance.</p> <ul style="list-style-type: none"> - Assumption of Risk/Acknowledgement Form regarding best practices at time of move-in. - Increased risk of living in residence halls for students in high risk groups; encourage them to make an informed decision reviewing CDC guidance before choosing to live on campus. - Housing policy and move-in procedure changes to reflect staggered move-in process from August 11–15. [revised 7-11-2020] - Personal hygiene expectations - CDC guidance shifts - State Government Updates 	Housing; Student Life	Draft of topics and distribution timeline by June 1
	<p>Create signs and messages for appropriate residence hall placement to ensure students are reminded of policy changes and behavioral expectations while social distancing.</p> <ul style="list-style-type: none"> - Expectations for elevator use - Expectations for stairwell spacing - Expectations for social distancing in public common areas such as lounges, kitchens, computer labs, restrooms, the clubhouse, and the game room. - Expectations for the use of required face coverings in all public spaces (any space exterior of the resident's personal apartment). - Expectations for use of hand sanitizer [Above revised 7-11-2020] 	Housing; Marketing	On or before August 3
	<p>Create and disseminate promotional materials such as fliers and pamphlets that provide the most essential informational reminders about infectious disease safety. Place in residence hall rooms prior to student arrival to campus.</p>	Housing; Marketing	On or before August 5
	<p>Create and disseminate an assumption of risk statement electronically that students must complete prior to return to campus that includes heightened risk associated with residence hall living during a pandemic. This will be a fully automated, touchless transaction.</p>	Housing; Legal Counsel	TBD (waiting on USG) [revised 7-11-

			2020]
Training and Preparation for Housing First Responders (Includes Housing Safety Assistants and Resident Assistant Staff Members)	<p>Create and implement training and protocols to be utilized for COVID19.</p> <ul style="list-style-type: none"> - Responding to a suspected COVID19 person. - Quarantine procedures. - Programming and engagement via electronic means. - Touchless delivery of services. - Expectations for sanitation of workspaces. - Expectations regarding PPE use. - Health and safety inspection modifications during social distancing periods. <p>Maintenance of sanitary workspaces in common use areas.</p> <ul style="list-style-type: none"> - Maintaining plexiglass shields for reception desks. - Cloth protective face coverings for front line staff and expectations for use and cleaning. - Sanitizing wipes, sprays, paper towels, etc. <p>Maintaining sanitary work areas.</p> <ul style="list-style-type: none"> - Sanitizing aerosol sprays for hard surfaces such as desks, desk chair, office staff bathrooms, electronics, etc. <p>Update existing housing policies and protocols to reflect social distancing expectations and ensure that staff are appropriately trained to enforce.</p> <ul style="list-style-type: none"> - Mail delivery 24-hour delay in receipt and touchless sign out process. - Students should comply with social distancing guidelines in all common spaces per signage. - Students must wear cloth face coverings in all inside campus buildings as provided in the above USG directive. [Above revised 7-11-2020] - Guest policies and sign in procedures; no outside guests while social distancing. - Students who egregiously violate policy guidelines will be cited for failure to comply. 	<p>Housing; Campus Police; Health Clinic</p> <p>Housing; Business Affairs; Corvias</p> <p>Housing; Business Affairs; Corvias Conduct</p>	<p>Prepared by July 24 Delivered by Aug 4</p> <p>Ordered by May 31 In place by August 1</p> <p>In place by August 1 (notify students of changes by June 15)</p>
Update Move in Process to reflect Social Distancing Expectations	<p>Institute a gradual move-in period over a series of 5 days.</p> <ul style="list-style-type: none"> - Students will receive an assigned move in appointment of 3 hours in length. [Above revised 7-11-2020] 	Housing; Financial Aid	Procedures in place by August 1

	<p>specific steps for maintaining proper kitchen sanitation.</p> <ul style="list-style-type: none"> - Provide one cloth protective face covering per student to encourage protective face covering use—placed in student bedroom prior to arrival to campus. 		
Facilities Updates During Social Distancing	<p>Change common area bathrooms to key only access for staff member use during social distancing periods.</p> <ul style="list-style-type: none"> - Students use own personal bathrooms. - Staff need a key issued for use. - Provide sanitation supplies for bathrooms so that staff can disinfect between uses. 	Corvias	Complete by August 1
	<p>Installation of Plexi Glass Shields on reception desks and on the desks of the three primary daytime housing staff members (Director, Assistant Director, Residence Life Coordinator.) [Above Revised 7-11-2020]</p> <p>Cover and turn off water fountains located in public areas. [Above revised 7-11-2020]</p>	Corvias; Plant Ops	Installed by August 1
		Corvias [Revised 7-11-2020]	August 1 [Revised 7-11-2020]
Housing Response Protocol for COVID-19 Exposure (subject to change per CDC guidance changes and updates)	<p>SCENARIO 1: Student reports symptoms of COVID-19 to Housing and Residence Life.</p> <ul style="list-style-type: none"> - Staff completes the online report form for suspected COVID-19 infection and contacts the housing director for further instructions. - Direct student to telephone the health clinic for a tele-evaluation of symptoms. - Student may then report to the clinic to receive a COVID 19 test if health center believes test is warranted. - The health clinic will contact the GDPH to begin the contact tracing process in cooperation with EGSC. - Student must self-quarantine within assigned residence hall unit until outcome of tests are received. - Student roommates must self-quarantine within assigned residence hall unit until student receives test results. - If student is confirmed with positive test, student will continue to quarantine in place within their residential unit for 14 days, or may go home for 14 days and continue online for that time. - Upon verification of the positive test, the other 3 	Housing; Health Clinic	May 30 or ASAP

	<p>roommates of student will be tested.</p> <ul style="list-style-type: none"> ○ If roommates positive, all students will continue to quarantine in place for 14 days or may choose to go home. ○ If negative, students (A) receive the option of going home or to a friend’s house away from campus for the duration of student one’s quarantine period or (B) roommates may stay in their room but only if their positive testing roommate elected to go home for quarantine. They would need to sanitize their space to ensure no further spread of virus. <ul style="list-style-type: none"> - If symptoms are severe and persistent as outlined within CDC and GDPH guidelines, student may be transported to Emanuel Medical Center for more extensive treatment. - Students will maintain their participation in courses via online instruction as able to do so, and should notify professors of this change. - Any confirmed COVID-19 student(s) must present proof of medical clearance before physically returning to class. <p>[Entire section above revised 7-11-2020]</p> <p>SCENARIO 2: Student reports exposure to confirmed infected individual.</p> <ul style="list-style-type: none"> - Complete the online report form for suspected COVID-19 exposure and call housing director for further instructions. - Direct student to phone the health clinic for a tele-evaluation of symptoms. - Student may then be asked to report to the clinic to receive testing depending on the amount and type of exposure to infected individual. - The health clinic will contact the GDPH to begin the contact tracing process in cooperation with EGSC. - Student will self-quarantine within assigned residence hall space pending results of test (if testing is completed) - Roommates will be notified to maintain adequate sanitation and social distancing guidelines within the apartment until test is processed. - If test is negative, students go can proceed under routine social distancing guidelines for all students. - If test is positive, see scenario 3. 	<p>Housing; Dining; Student Affairs</p>	<p>May 30 or ASAP</p>
--	---	---	---------------------------

[Entire section above revised 7-11-2020]

SCENARIO 3: Student reports confirmed diagnosis of COVID 19 to Housing and Residence Life

- Student will be quarantined for 14 days from diagnosis within assigned residential space.
- Upon verification of the positive test, the other 3 roommates of student will be tested.
 - o If roommates positive, all students will continue to quarantine in place for 14 days or may choose to go home.
 - o If negative, students (A) receive the option of going home or to a friend's house away from campus for the duration of student one's quarantine period or (B) roommates may stay in their room but only if their positive testing roommate elected to go home for quarantine. They would need to sanitize their space to ensure no further spread of virus.
- If symptoms are severe and persistent as outlined within CDC and GDPH guidelines, student may be transported to Emanuel Medical Center for more treatment.
- Any confirmed COVID-19 student(s) must present proof of medical clearance before returning to class.
- Housing notifies Corvias of the diagnosis and location of infection so that they can amend their procedures for entering rooms accordingly.
- Housing notifies Student Affairs to report information about the student so that appropriate notifications can be distributed to professors.
- Housing will pick up and deliver meals for students who are quarantined. Meals will be enclosed in a bag that can be hung on the outside of the doorknob of the apartment to prevent interaction with infected individuals.
- Student must notify faculty of quarantine status and continue coursework via online delivery method as able to do so.

[Entire section above revised 7-11-2020]

Housing; Student Affairs; Dining Svcs.

May 30 or ASAP

Resident Mail Delivery

During periods of social distancing, housing will institute a 24-hour mail delivery delay to ensure time for decontamination prior to transport to housing for distribution.

Housing

August 1

	<ul style="list-style-type: none"> - Once packages arrive, they will be placed in the “quarantine area” or the mail room for newly delivered mail. - 24 hours later, the packages will be logged and taken to housing for distribution. <p>Packages will then follow the normal process of check out at the clubhouse.</p> <ul style="list-style-type: none"> - Students will no longer physically sign for packages. - ID will be checked to confirm identity. Housing staff will sign for the package on the student’s behalf. - Student will take possession of the package outside of the mail package office in the bigger common area of the clubhouse. <p>[Entire section above revised 7-11-2020]</p>	Housing	August 1
Materials and Supplies	<ul style="list-style-type: none"> - Purell stations (10 total) - Purell station refills (TBD) - Disinfectant sprays and Clorox Wipes for common spaces - Extra soap refills for public bathrooms to reflect increased use. <ul style="list-style-type: none"> - Plexi-glass desk shields (5 – measurements will dictate size) <p>[Above revised 7-11-2020]</p> <ul style="list-style-type: none"> - Cloth protective face coverings to distribute to housing residential students. (500 minimum order) - Disinfectant sprays and Clorox Wipes for office spaces <ul style="list-style-type: none"> - Outfit lab computers with web cams should we switch to online course delivery. - Move computers within residence hall spaces to meet social distancing guidelines; install additional connections and network splitters as necessary. 	<p>Corvias</p> <p>Business/ Plant Operations</p> <p>I.T. Services</p>	<p>August 1</p> <p>August 1</p> <p>August 10</p>

Dining

EGSC Retail Dining will open with Mobile Ordering or Kiosk Ordering strongly encouraged for placing orders. Dining Services would like to have Mobile Credentials installed for touchless payment and Reverse ATM on campus to provide options to have a prepaid card for touchless payment in all areas.

Dining Services will provide carryout options for students not comfortable eating in the RLB Dining Hall. Students living in residence halls that are ill or in quarantine will have meals delivered to them by the housing staff.

EGSC Dining Services is actively working with our vendors to service our area according to CC and DPH guidelines. We will sanitize every 30 minutes, especially the common high-touch areas in the RLB Dining Hall. At retail locations, we will also sanitize the credit card terminals, doorknobs, and counters every 30 minutes.

In the RLB Dining Hall, Student Lounge, and service lines, social distancing guidelines will be observed to reduce the risk of contamination. There will no longer be a self-service line at the salad bar. Plexiglass shields have been installed for retail locations, EGSC Café, the student lounge pickup window, and Common Grounds.

EGSC Dining Services employees are trained, annually, on proper PPE guidelines and have completed ServSafe Handler Hourly and ServeSafe Re-Opening Guidance regarding COVID-19 precautions. All DPH guidelines are strictly followed for sanitation, safety, and social distancing.

[Above section added 7-11-2020]

**Describe the plan for using your dining facilities for the Fall Semester 2020 with the assumption that social distancing is in place. Please include the following for each face-to-face dining facility:*

- Name of dining facility Richard L. Brown Dining Hall
- Type of operation (grab and go, sit down, cafeteria-style, food court-style, etc.) Cafeteria -style, no self-served stations with sit down dining area.
- Typical user (faculty, staff, students) Students, staff, and faculty
- Current occupancy 139
- Social distancing occupancy 89 guest at tables and 6 guests in line
- Changes in delivery or meal options Continuous service if necessary, to accommodate social distancing occupancy. Pick up available for residential students by housing staff if student is quarantine for delivery. Meals and beverage package so housing staff may drop off with no contact.
- Changes in accepting payment (cash, credit card, student ID card, etc.) Credit card, Dining Dollars and Bobcat Card, No cash payments if possible
- Changes in meal plans Allow takeout to accommodate social distancing guidelines.
- Requirement for employees (protective face coverings, PPE, etc.) Wearing protective face covering and gloves and barriers to allow the 6 Ft distance between guest and servers. New desk for cashier with plexiglass for protection.

**Describe the plan for using your dining facilities for the Fall Semester 2020 with the assumption that social distancing is in place. Please include the following for each face-to-face dining facility:*

- Name of dining facility EGSC Cafe
- Type of operation (grab and go, sit down, cafeteria-style, food court-style, etc.) Food Court Style -
- Typical user (faculty, staff, students) Students, staff, and students

- Current occupancy 51
- Social distancing occupancy 18 Guest at tables and 7 guests in line for Picking up orders.
- Changes in delivery or meal options Orders placed with EGSC Mobile App or Kiosk
- Changes in accepting payment (cash, credit card, student ID card, etc.) Credit Card, Dining Dollars, Bobcat Card, no cash payments if possible
- Changes in meal plans Order Orders picked up after notification at student lounge window only using crowd control barriers with floor stickers for 6’ft distance reminder.
- Requirement for employees (protective face coverings, PPE, etc.) Wearing protective face coverings and gloves and plexiglass shields at both windows.

*Describe the plan for using your dining facilities for the Fall Semester 2020 with the assumption that social distancing is in place. Please include the following for each face-to-face dining facility:

- Name of dining facility Common Grounds Coffee Shop
- Type of operation (grab and go, sit down, cafeteria-style, food court-style, etc.) Grab and Go with limited seating.
- Typical user (faculty, staff, students) Students, staff, and faculty
- Current occupancy 8
- Social distancing occupancy 2
- Changes in delivery or meal options Orders placed with Mobile App or Kiosk and pickup
- Changes in accepting payment (cash, credit card, student ID card, etc.) Credit Card, Dining Dollars or Bobcat card – all payments accepted on Mobile Ordering and Kiosk.
- Changes in meal plans None
- Requirement for employees (protective face coverings, PPE, etc.) Protective face covering and Gloves, Plexiglass shield

“Opening our dining facilities in a safe manner for the fall will be imperative. Like residence life, each institution has different types of dining facilities, meal plans, and requirements. Thus, the only specific guidance for dining halls is that they must allow for social distancing and discourage students gathering in groups.”

Counseling Services

“Counseling services should be prepared to operate at full capacity. Social distancing may require alternate arrangements for delivering counseling services based on the current physical space of the counseling center and/or individual offices.

*Counseling centers should submit the following as part of their plan for fall operations:

1. Number of full-time counselors
2. Number of part-time counselors
3. Current ratio of counselor FTE to Spring Semester 2020 student FTE
4. Number of counselors who will be able to continue to serve students in their current physical space
5. Number of counselors who will need either different physical space or will need to engage in alternate arrangements (tele-counseling)

6. Needs for alternate physical spaces
7. Current number of counselors approved to deliver tele-counseling
8. Practices to be implemented for face-to-face counseling visits that ensure social distancing from the time a student schedules an appointment to the time the student leaves the appointment.
9. Resources needed to stand up a fully operational counseling center for fall with the alternate delivery options.”

The EGSC Office of Counseling and Disability Services offers support to all students on the main campus in Swainsboro as well as the satellite campuses in Augusta and Statesboro. The Center employs 2 full time Licensed Professional Counselors to provide in-person and Tele-Mental Health services to students on all 3 campuses. Students will schedule an appointment to see a counselor by calling the office or sending an email.

The EGSC counselors have satisfied the required 6 hours of Tele-Mental Health training within the last 5 years. To remain up to date on best practices for in-person counseling and Tele-Mental Health services, counselors will read articles, participate in webinars and other forms of training sessions and consult with colleagues at similar institutions throughout the USG.

[Above revised 7-11-2020]

The Office of Counseling and Disability Services will be available to support students who express anxiety or other concerns related to the return to campus. The counselors are prepared to teach strategies for managing stress related to being a college student during the COVID-19 pandemic.

[Above revised 7-11-2020]

Appointments can be scheduled by calling the office or sending an email request to the counselor. The procedures for scheduling appointments will be available to students by the start of the fall semester.

[Above revised 7-11-2020]

An employee of the counseling center who tests positive for COVID-19 will follow the protocol established by the Human Resources Department. Students who test positive for COVID-19 will follow the protocol established by the institution. The remaining staff at the counseling center will be available to provide support to student caseloads impacted by a positive employee. Students who test positive will have the option to utilize telephone or Zoom services for support.

[Above revised 7-11-2020]

To further improve the safety of the counseling center employees and students, several protective measures will be in place. A glass window will separate students from the receptionist upon check-in. Hand sanitizer will be available for student use at the entry point to the counseling center. Employees will follow the guidelines established by the CDC and USG regarding proper use of PPE. The guidelines will be reviewed prior to the start of the semester and periodically throughout the semester. All staff and

students will follow the USG guidelines for wearing face coverings. Offices will be sanitized based on CDC guidelines after each in-person visit. Any student who tests positive will be instructed to report the condition to the Student Health Clinic and follow the guidelines established by the College. Tele-health services will be available to students who test positive for COVID-19.

[Above revised 7-11-2020]

The following supplies are needed to promote the health and safety of those visiting the counseling center: disposable masks, hand sanitizer, disinfectant spray and wipes, and disposable gloves.

[Above revised 7-11-2020]

Swainsboro Campus:

The Office of Counseling and Disability Services on the Swainsboro Campus is in the Academic Building near the Student Health Clinic. The counselor will continue offering Tele-Mental Health services to all students. Sessions in the office will be limited to students who would most benefit from in-person visits. Accommodations will be made for walk ins although appointments will be strongly encouraged. Students seeking Counseling and Disability services will access the office using the hallway to the left of the Student Health Clinic. Room C157 has been approved as a waiting room for students who present for in-person sessions. Seating would be at least 6 feet apart. Students may also choose to receive a phone call from the counselor when it is time for his or her appointment. Use of the current physical space to provide in-person counseling while practicing social distancing will be a challenge. It may be necessary to rearrange and/or remove some of the furnishings in the office to allow 6 feet between the student and the counselor. In the alternative, the counselor and student may meet in a conference room where social distancing is guaranteed. Students who present for face to face sessions will be required to wear a protective face covering. Counselors will be required to wear protective face coverings during in-person sessions. The office will be sanitized after each in-person visit following guidelines established by the CDC. Supplies needed include Lysol disinfectant spray, sanitizing wipes, hand sanitizer, and face coverings.

Augusta Campus:

The Office of Counseling and Disability Services will continue offering Tele-Mental Health services to all students. Sessions in the office will be limited to students who would most benefit from in-person visits. Accommodations will be made for walk-ins although appointments will be strongly encouraged. In-person sessions will be conducted in EGSC's conference room in Galloway Hall where social distancing is assured. Students will sit in the waiting area in chairs that are 6 feet apart or wait for a phone call from the counselor when it is time for his or her appointment. Students who present for in-person sessions will be required to wear a protective face covering. Counselors will be required to wear protective face coverings during in-person sessions. The office will be sanitized after each in-person visit following guidelines established by the CDC. Supplies needed include Lysol disinfectant spray, sanitizing wipes, hand sanitizer, and face coverings.

Statesboro Campus:

The Office of Counseling and Disability Services will continue offering Tele-Mental Health services to all students. Use of the current physical space to provide in-person counseling while practicing social distancing will be a challenge. It may be necessary to rearrange and/or remove some of the furnishings in the office to allow 6 feet between the student and the counselor. It may be necessary to use the conference room to assure social distancing. Sessions in the office will be limited to students who would most benefit from in-person visits. Accommodations will be made for walk-ins although appointments will be strongly encouraged. Students who present for in-person sessions will be required to wear a protective face covering. Students who present to see the counselor will sit 6 feet apart in the waiting area or wait for a phone call from the counselor when it is time for his or her appointment. Students who request proctoring services will schedule an appointment with the counselor. Seating will be 6 feet apart in all testing rooms and students will be encouraged to wear a protective face covering. Counselors will be required to wear protective face coverings during in-person sessions. The office and testing room will be sanitized after each in-person visit following guidelines established by the CDC. Supplies needed include Lysol disinfectant spray, sanitizing wipes, hand sanitizer, and face coverings.

Health Center

Health centers should be prepared to operate at full capacity for the fall semester. Health centers should submit the following as part of their plan for fall operations:

1. Practices to be implemented for face-to-face health center visits from scheduling to delivery and follow-up appointments.
2. Practices to be implemented for telemedicine when needed or appropriate.
3. Resources and equipment needed to stand up a fully operational health center for fall.

In order to function and adhere to national and state safety regulations the following guideline will be implemented:

- The student health clinic will now receive patients by appointment ONLY (unless in cases of emergency or extreme circumstance), scheduling will be done in order prevent overcrowding and to allow for proper cleaning and disinfecting of the exam room after each student
- Students presenting more than 15 minutes late for their scheduled appointment will be asked to reschedule their appointment to the next available time slot to ensure safe work efficiency within the clinic and prevent overcrowding of the clinic
- Upon arrival to and inside the student clinic the six (6) feet social distancing guideline will be followed and denoted by floor markings that represent this adequate spacing. Also chairs within the clinic will be placed in such a manner to prevent close proximity congregating
- Upon arrival face protective face coverings will be given and must be worn by ALL students for their entire duration while in the clinic
- If students for any reason are unable to physically present to the clinic then telehealth services will be offered via audio/visual software (supported by the secure Doxy or Azalea electronic systems) or via telephone. Students are able to utilize either computer or phone to access telehealth services
- Only students who are being seen will be allowed into the clinic – (no other companions of the student allowed in unless they are seeking medical treatment themselves)

- There will be no more than three (3) students allowed within the waiting room of the clinic at any time to assist with infection prevention, cross contamination, and overcrowding. The main door to the clinic will be closed when the waiting area reaches full capacity
- Any student presenting with respiratory symptoms or clinical features of COVID-19 virus will be properly screened, as well as flu and strep tested at the patient's consent
- Any student who warrants (or personally requests) COVID-19 testing will then be referred for said testing with medical orders issued by the clinical practitioner. Nasopharyngeal (NP) and/or oropharyngeal (OP) testing is offered through the Emanuel Medical Center drive through test site here in Swainsboro.
- Students will be required to self-quarantine while undergoing testing and pending results (results are usually returned within 2-5 days)
- Upon the receipt of a positive test result, the student and GA Dept. of Public Health will be notified
- Students will be expected to quarantine as mandated by the GDPH upon receipt of positive test results
- Following the quarantine period for any student with a positive COVID -19 test result, the student must then meet GDPH guidelines before safely being permitted to return to class and the general population
- Notifications of necessary quarantine, and medical releases for returning to class will be given via signed letter to all students by the clinical practitioner
- Negative or Positive test result forms will be available and can be issued to all students tested
- Sheila Bramlett (Campus contact) and Linda Upchurch (Director of Nursing) will be notified immediately upon the receipt of a positive COVID- test result however student's name and other sensitive information will be omitted in accordance with Health Insurance Portability and Accountability Act (HIPPA) regulations.

RESOURCES NEEDED IN ORDER TO ADEHRE TO THESE PROTOCOLS

- Floor/tape markings for six (6) feet social distancing
- Computer or laptop with audio and visual capabilities
- Additional hand sanitation station in waiting room of clinic or at entry to health clinic

Student Organizations

Student organizations and the opportunities they provide students are critical components of the student experience. Social distancing will not allow for many of the traditional activities and events that students have come to enjoy and expect. In that spirit, institutions should plan for providing alternate activities and experiences that promote social distancing and engagement at the same time. Institutions should also plan for ways to support student organizations in planning for different types of organizational meetings, activities, fundraisers, etc.

*Please submit any significant changes in the student handbook or in procedural operations that will need to occur in order to meet the needs of student organizations during social distancing expectations.

As the student calendar of events is evaluated, choices will be made as to the best mode of delivery. Safety guidelines will be published and distributed to all staff and members of student organizations. Safety guidelines will be posted in prominent locations where students congregate. Additionally, student leaders will receive training in hygiene, sanitation, and social distancing. This training will occur during the first scheduled meeting of the semester.

[Above revised 7-11-2020]

If a student or staff person becomes ill, they will follow the guidelines set forth by the College.

[Above revised 7-11-2020]

- All clubs and organization will be allowed to meet virtually and utilize Zoom or other approved Virtual meeting applications.
- Student clubs and organization will be permitted to meet with limited grouping of 5 or less members provided they adhere to the 6ft rule.
- Student clubs and organizations must submit request for all meeting/events both virtual and face to face to student life 2 weeks prior to event or meeting.
- All events/meetings that are requested should adhere to EGSC health & safety guidelines.

“Student organization recruitment activities must adhere to the current social distancing requirement in place. If an organization cannot ensure social distancing, the organization should consider deferring recruitment to the spring semester.”

Bands and Choral Groups

“Decisions related to band and choral groups will be made with the most up-to-date social distancing guidelines.”

EGSC doesn't have a band or choral group on campus at this time.

Campus Recreation

Student Life has requested plexiglass partitions to be placed at the Help Desk and in the gaming center area to assist with minimizing contact with students and staff.

[Above revised 7-11-2020]

Student Life also plans to limit/minimize access to the JAM Extension to help limit contact and stay within the policies and guidelines set by the USG and EGSC. Only 2-3 people will be allowed to walk on the indoor track. One person will be allowed at each gaming station. Two people will be allowed at each of the pool tables, foosball table, and table tennis to maintain social distancing guidelines.

[Above revised 7-11-2020]

There are neither locker rooms nor showers located in the JAM Student Center; thus, there will be no need for safety precautions concerning them. Also, there are no memberships required for the public to use the facilities. All persons on campus are required to adhere to the safety guidelines established by the College.

[Above revised 7-11-2020]

EGSC will prominently display sanitation policies and guidelines in and around the JAM Student Center. Student Life has a plan in place to clean all areas being used by faculty, staff, and students. No one will be permitted to use areas without following proper sanitation protocols.

[Above revised 7-11-2020]

Student Life will continue to provide waivers for students and outside companies and organizations that are hosted on campus. Events hosted on campus will adhere to the guidelines and policies of both Student Life and EGSC and will be given the policies prior to their campus visit.

[Above revised 7-11-2020]

*Using best practices for gyms and recreation centers, please provide the practices for opening your campus recreation center that allows for social distancing. Please include the following:

- Hours of operation
- Staffing levels
- Occupancy changes
- Sanitation practices
- Locker room practices/restrictions
- Overall policies related to the operations during COVID-19 (e.g. staggering machine usage to every other machine, canceling group classes, etc.)

See below concerning Student Life.

Co-curricular Requirements

Any co-curricular requirements for degree attainment should be reviewed and revised as necessary to take into account limitations imposed by social distancing and the overall COVID-19 situation. Alternate arrangements should be granted in cases where it will be impossible for a student to meet the requirement.

All co-curricular activities must be approved by Director and/or Coordinator of Student Life prior to use of Student Center and other areas monitored by Student Life and adhere to all social distancing requirements.

Student Unions and Other Community Gathering Locations

Student Unions, centers, and other community gathering locations across campuses should review all of their current practices to determine which practices need to be altered to take into account social distancing. Large events scheduled for the Fall Semester 2020 semester should follow the institutional plan for large events.

Student Life:

- Family and Friends Fun Day Committee is looking into planning the event with the intent to adhere to Social Distancing guidelines.
- Secondary Plan would involve rescheduling the event to spring 2021.
- All student activity areas will be opened to the students with limited access and sanitation guidelines to follow.
- Students will only be allowed to walk the track in the new student center gym unless otherwise specified and approved by Director and Coordinator of Student Life.
- Students must keep a distance of at least 6ft apart while walking the track in the new student center.
- **No team sports will be played in the student center gym.**
- Add glass partition/shields between each gaming station section to assist with social distancing
- Sanitation stations will be adequately positioned in the student center gym.
- Student Center will temporarily not be open to the community or general public.

Student Events/Programs:

- All events and programs hosted by Student Life and SGA will have a limited face to face interaction between students, faculty and staff.
- All event planning companies will be required to follow sanitation guidelines outline by the USG and EGSC. They must adhere to these guidelines at all times while on campus.
- An on campus and virtual calendar have been created to continue facilitating student engagement both on and off campus.
- There will be **NO Intramural Sports** for Fall Semester 2020.
 - ALL Intramural Sports are cancelled for the Fall Semester 2020.
 - Student Life is planning to resume Intramural Sports in the spring.
- Large Group Activities – There will be no large group activities hosted by student life in Fall Semester 2020. Any and all activities planned will adhere to the rules and guidelines required by the USG and EGSC.
- Cheerleading-TBA
- Homecoming TBA (Spring Semester event)
- Conferences – no conferences during the fall
- Welcome week activities have been created to have limited to no contact between students, faculty and staff.
- Clubs and Org Meetings- Student Orgs and Club to meet on Zoom and in Small Group Setting of no more than 5-10 people at proper spacing.

Student & Staff Safety:

- Staff will be required to wear protective face coverings as provided in the above USG directive and make sure that the students follow the six (6) feet apart rule and the protective face covering requirement.
- Gym/Multipurpose Room will be closed from basketball and other sports and can only be used for track/walking in the Fall Semester 2020.
- Only one person can use each game console at a time.
- Only 2 people can play pool and other table games systems during Fall Semester 2020.
- No students will be allowed to congregate in area where social distancing cannot be enforced. 6ft Rule.
- Each item checked out from the Help desk will be cleaned and sanitized by Student Life Staff.
- Only a limited number of students will be allowed in the game room at a time. Once students leave, a new group of students will be allowed to utilize game room.
- Additional sanitation stations will be added to the Student Center Lobby, Game Room and other areas with constant traffic. This will be accompanied with appropriate signage for special instructions.
- Student conduct investigations and hearings will be conducted via Zoom or with special social distancing guidelines.

Bobcat Bridge:

- The Bobcat Bridge will continue operation in the Fall Semester 2020 with limited access.
- Operation Days: Every Friday unless otherwise specified.
- Emails will be sent to student with Bobcat Bridge schedule time on Wed and/or Thursday prior to opening on Fridays.
- Students will still be able to complete request form at
 - o <http://www.ega.edu/bobcatbridge>.
- Students can also submit request for Bobcat Bridge assistance via email to vcheers@ega.edu.
- Students will be provided with up to two bags of items from the Bridge.
- Only two students will be allowed inside the Bobcat Bridge Pantry Space at a time. This does not include Student Workers or Volunteers.
- Two student workers or volunteers will be allowed inside the Bobcat Bridge Food Pantry to assist with handling of perishable and nonperishable item distribution.
- Sanitation stations will be placed outside the Bobcat Bridge area to assist with sanitation going in and out of the bridge.
- All students and volunteers in the Bobcat Bridge pantry area will be required to wear protective face coverings as stated in the above USG directive.

CONTINGENCY PLAN #2 – Fall classes begin fully online and

CONTINGENCY PLAN# 3 – Classes and operations must go to an online format for a period of time during the semester

The USG will work in tandem with the Governor's office, the Governor's COVID-19 Task Force, and the Georgia Department of Public Health (GDPH) to make public health-informed decisions affecting the status of any of our campuses or our system.

Contingency plans 2 and 3 will require similar planning, in that classes and operations must be able to start or transition to an online, remote environment if the COVID-19 situation requires us to do so. Where noted, there will be different submission requirements based on the timing for any move to an online environment. Decisions about moving online will be made at the University System Office in consultation with the Governor's office, the Governor's COVID-19 Task Force, and GDPH. No institution shall make the decision to move online on their own.

Using the Spring Semester 2020 semester as a reflection point with lessons learned, institutions should implement best practices in the online delivery of courses and in the remote delivery of institutional services. These plans should include employees working remotely when possible and employees working on campus. Now is the time to conduct after actions reviews to identify opportunities for improvement in online delivery, as well as inventory the necessary resources that would be required to move to this environment again in the future.

*What preparations will your campus need to make to ensure a smooth transition to an online environment? Will there be additional ramp up time required? If so how much?

Residence Life

In the event campuses must begin or move to an online instructional environment, institutions should plan for students to move into the residence halls and remain in the residence halls whenever possible. Institutions will comply with any directives issued at the state level that conflict with this guidance.

*In the event a campus is required to start the semester online, the campus should use the Contingency 1 plan for move in with social distancing.

Housing and Residence Life will operate under the auspices of Contingency Plan 1 even if EGSC begins the term fully online, or switches to online instructional delivery at the middle of the term.

*In the event a campus moves to a fully online academic environment (temporary or for the remainder of the semester), the campus should develop a plan for additional practices/policies to be implemented whereby students are required to follow any additional directives issued.

We will defer to gubernatorial and USG guidance if a move out action needs to be executed at any time during the term. We will follow the emergency move out plan from Spring Semester 2020 at that time which emphasizes social distancing. Our Spring Semester 2020 move out plan worked incredibly well and needs no modification.

Note: As part of Contingency Plan 1 institutions should have move out procedures in place allowing for social distancing. Those plans would be in place for move out during any part of the semester.

Dining

In the event a campus moves to fully online academic delivery and is able to retain students in the

residence halls, dining facilities will be expected to operate in a decreased manner to allow for students with meal plans to access dining services with the strict enforcement of social distancing measures.

*Provide any alterations to the socially distanced plan outlined in Contingency Plan 1 that would need to be in place during a move to online instruction. Include any changes in operations or availability of dining options.

Limiting hours for both retail locations, Common Grounds and EGSC Café. Residential Dining would continue for limited seating or carryout.

Counseling Services

Counseling services should be prepared to operate at full capacity online.

*Describe any changes in operations that must occur to move to online delivery of counseling services. Include any additional training/certifications that should be in place, as well as any technology requirements.

Contingency Plan 2

The Office of Counseling and Disability Services for the Swainsboro, Augusta and Statesboro Campuses will provide Tele-Mental Health services to students if classes are wholly online for Fall Semester 2020. Counselors will utilize the existing Microsoft Teams accounts to provide support to students via phone and/or video chat. Counselors have the credentials and have met the training requirements to provide Tele-Mental Health services.

Contingency Plan 3

The Office of Counseling and Disability Services for the Swainsboro, Augusta and Statesboro Campuses will provide a seamless transition to only Tele-Mental Health services if classes are moved to wholly online for a specified period of time during Fall Semester 2020. Counselors will continue utilizing the existing Microsoft Teams accounts to provide support to students via phone and/or video chat. Counselors have the credentials and have met the training requirements to provide Tele-Mental Health services.

Health Centers

In the event academic courses move online temporarily or for the remainder of the semester, it is expected that health centers will continue to operate as planned for in Contingency Plan 1.

*Describe any changes to practices/policies that would need to occur to still serve students through telemedicine or necessary in-person appointments.

The health center will operate as outlined in Contingency 1.

Student Organizations

In the event a campus is required to move to a fully online delivery of academic courses, student organization activity that cannot be done in an online environment may be cancelled for at least the same duration of time as the remote online requirements are in place.

All clubs and organization will be allowed to meet virtually and utilize Zoom or other approved Virtual meeting applications.

Clubs and organizations will be required to get prior approval from Director and/or Coordinator of Student prior to hosting meetings/events that will require face to face interactions.

Student conduct investigations and hearings will be conducted via Zoom or with special social distancing guidelines.

Bands and Choral Groups

In the event a campus is required to move to a fully online delivery of academic courses, band and choral group activities that cannot be done in an online environment may be cancelled for at least the same duration of time as the remote online requirements are in place.

EGSC does not have a band or choral group on campus currently.

Campus Recreation

In the event a campus is required to move to a fully online delivery of academic courses, campus recreation centers and activities that cannot be done in an online environment may be cancelled for at least the same duration of time as the remote online requirements are in place.

Co-curricular Requirements

Any co-curricular requirements for degree attainment should be reviewed and revised as necessary to take into account limitations imposed by a move to fully online delivery and the overall COVID-19 situation. Alternate arrangements should be granted in cases where it will be impossible for a student to meet the requirement.

Academic Aerobics Classes requested will be held in the Student Center Gym Mondays and Wednesdays 9a-9:50a and Tuesday and Thursday 12:15p-1:05p with instructor Johnna Eaton. Contingent upon approval until classes offered fully online.

Student Unions, Centers and Other Community Gathering Locations

In the event a campus is required to move to a fully online delivery of academic courses, student unions, centers, and other community gathering locations may be closed for at least the same duration

of time as the remote online requirements are in place.

Guidelines should be followed from Contingency Plan 1 until remote online requirements are in place.

ARCHIVED
The COVID-19 Public Health Emergency Declaration ended at midnight on May 11, 2023.
Information for archival use only.

5. Enrollment Management

- Jim Beall, AVP for Academic Affairs and Enrollment Management (Chair)
- Mike Moran, Interim Assistant of the Learning Commons
- Michael Wernon, Director of Financial Aid
- Lynette Saulsberry, Registrar
- Jennifer Fields, Assistant Director of Admissions
- Brandy Murphy, Coordinator of Dual Enrollment

The following is the plan of the Enrollment Management Sub-committee:

Guiding principle

The guiding principle in the develop of the contingency plans was the safety and well-being of our prospective students, students, faculty, staff and visitors is our priority.

Action steps necessary to carry out this plan

Each department head will review the fall contingency plans with staff in their respective departments by July 15th. Before any contingency plan is activated, a meeting (zoom) will be called to review the contingency plan that is about to be implemented.

Primary Responsibility

Each department head will implement the appropriate contingency plan when instructed to do so by the Associate Vice President of Academic Affairs and Enrollment Management.

- 1) Admissions, Recruitment, and Orientation – Admissions Director
- 2) Registrar Office – Registrar
- 3) Financial Aid Office – Director of Financial Aid

“Contingency plan 1 - fall classes begin with social distancing expectations

Implementing best practices in the time of COVID-19 for enrollment management is essential. Student success initiatives related to retention are addressed in the Academics & Research section of this document. Institutions must adapt their existing strategic enrollment management plans to account for the anticipated changes in recruitment, admissions, and retention.

*Provide the highlights of planned changes to the following:

- Recruitment strategy
- Admissions strategy
- Orientation and Welcome Week strategies
- Co-curricular retention strategy (beyond the classroom, advising, Momentum)
- Use of technology

*What markers/indicators will you be monitoring to gauge outcomes? While we recognize that

this situation has created substantial unknowns making it difficult to predict outcomes, to what initial outcomes will you benchmark?

Contingency Plan 2 – Fall classes begin fully online

Contingency Plan 3 – Classes and operations must go to an online format for a period of time during the semester

The USG will work in tandem with the Governor’s office, the Governor’s COVID-19 Task Force, and the Georgia Department of Public Health (GDPH) to make public health-informed decisions affecting the status of any of our campuses or our system.

Contingency plans 2 and 3 will require similar planning, in that classes and operations must be able to start or transition to an online, remote environment if the COVID-19 situation requires us to do so. Where noted, there will be different submission requirements based on the timing for any move to an online environment. Decisions about moving online will be made at the University System Office in consultation with the Governor’s office, the Governor’s COVID-19 Task Force, and GDPH. No institution shall make the decision to move online on their own.

Using the Spring Semester 2020 semester as a reflection point with lessons learned, institutions should implement best practices in the online delivery of courses and in the remote delivery of institutional services. These plans should include employees working remotely when possible and employees working on campus. Now is the time to conduct after actions reviews to identify opportunities for improvement in online delivery, as well as inventory the necessary resources that would be required to move to this environment again in the future.

*What preparations will your campus need to make to ensure a smooth transition to an online environment? Will there be additional ramp up time required? If so how much?

Implementing best practices in the time of COVID-19 for enrollment management is essential. Student success initiatives related to retention are addressed in the Academics & Research section of this document. Institutions must adapt their existing strategic enrollment management plans to account for the anticipated changes in recruitment, admissions, and retention.

*Provide any additional plans or requirements related to a fully online environment not addressed in Contingency Plan 1 for the following:

- Recruitment strategy
- Admissions strategy
- Orientation and Welcome Week strategies
- Co-curricular retention strategy (beyond the classroom, advising, Momentum)
- Use of technology

The contingency plans for each of these areas for contingencies 1, 2 and 3 is presented below

Admissions, Recruitment, and Orientation

Contingency Plan 1 - (Fall Semester 2020 Classes Begin with Social Distancing Expectations)

Admissions Operations

Daily Office Strategies

Typically, the EGSC Office of Admissions has a great deal of physical interaction with students, parents, staff, faculty, and guests. To best prepare a safe and healthy environment the Office of Admissions is proposing to put forth the following implementations for Contingency Plan 1.

Hours of Operations

- Monday – Friday 8:00 a.m. - 5:00 p.m. (subject to change)

Staff (Personnel) Scheduling

- Monday – Friday 8:00 a.m. - 5:00 p.m. (subject to change based on operating hours)

All personnel of the Office of Admissions must follow the health guidelines established for safety.

1. Staff required to wear face covering as provided in the above USG directive. It is the personal responsibility of the staff member to provide the face covering.
2. Strongly encouraged to wash hands frequent and thoroughly with soap and water and/or hand sanitizer, especially after touching common shared objects like doorknob, pens, telephone, etc.
3. Do not handshake, high five, or hug.
4. Cover your cough or sneeze. Use a tissue, your elbow, or inside shirt. Immediately discard any tissue you may have used or disinfect any area of your body with soap and water or sanitizer.
5. Avoid touching your face, eyes, or mouth.
6. Limit contact with anyone who appears to have an illness.
7. Be aware of your surroundings and conscious of your movements.
8. Maintain social distancing during events.
9. Remain in personal office space as often as possible.

Supervisors will reinforce behaviors, and ensure there is transparency of actions and situations, as in similar leadership methods within health and safety. This means cleanliness conversations and reviews.

With this said, the Office of Admissions plans to adopt a cleaning and disinfecting procedure. Each staff member will play their role in maintaining a safe and healthy environment so people can be assured.

1. Clean and disinfect hard surfaces after use (multiple times a day)- alcohol wipes of at least 70% will be provided to each staff member.
2. Cleaning and disinfecting of electronics such as tablets, touch screens, keyboards, mouse, and other machines that are used. Typically, alcohol-based wipes or sprays containing at least 70% alcohol can be used on electronics. (Advice will be sought by I.T.).

Furthermore, it is imperative that the layout of the Office of Admissions provides clear messaging that social distancing is being practiced.

1. Signage will be posted, and it will send a clear message to all people that the Office of Admissions is practicing the recommendations of the CDC, social distancing.
2. Individuals must remain in the designated waiting area maintaining 6-foot separation from others, until called upon by a staff member.
3. The front administrative desk will have an additional barrier to prevent individuals from coming closer than 6-feet to the individual working at the desk.
4. The Office of Admissions furniture will be rearranged to allow for social distancing.
5. The kiosk will need to have plastic keyboard protector to help with the frequent cleaning and disinfecting of the keyboard.
6. Barriers will be created to prevent individuals from freely leaving the waiting area and entering the workspace of staff members.
7. Each office space will be provided a protective barrier that separates the customer from the staff member.

Other preventative measures will include:

1. Access will be controlled.
2. One door will be used for entry.
3. A limit of 10 individuals (one person per party) will be allowed in the Admissions area when granted access.

Recruitment Strategies

Typically, the EGSC Recruiter is physically attending recruitment events and interacting personally with high school counselors and students. The nature of attending high school events changes from school to school and changes regularly. However, recruiters still plan to attend events to actively recruit students. When this is the case, recruiters are to follow the plan put forth by the Office of Admissions regarding safe and best practices for in-person recruitment.

Before the recruiter engages in an event, the event must be approved and deemed safe by the Office of Admissions (Assistant Director approval). Upon approval, the recruiter must follow the health guidelines, including but not limited to, those guidelines established for any event.

- 1) Required to wear protective face coverings as provided in the above USG directive.
- 2) Wash hands frequently and thoroughly with soap and water and/or hand sanitizer, especially after touching common shared objects like doorknob, pens, telephone, etc.
- 4) Do not handshake, high five, or hugs. When appropriate use your knuckles for keypads, doorbells, elevator buttons, etc.
- 5) Cover your cough or sneeze. Use a tissue, your elbow, or inside shirt. Immediately discard any tissue you may have used or disinfect any area of your body with soap and water or sanitizer.
- 6) Avoid touching your face, eyes, or mouth.
- 7) Follow social distancing guidelines.
- 8) Be aware of your surrounding and conscious of your movements.
- 9) Maintain social distancing as best as possible during events.

During visits to high schools, or other events, the EGSC Recruiters have displays and a table set up with informational material to allow students/counselors to collect information about EGSC. With students/counselors frequently coming to the table for information, it is in the best interest to protect our EGSC Recruiters by equipping them with a sneeze shield that will be placed on the table during events. The shield will need to be large enough in size to cover from the waist up to the top of the head and width of the body of the recruiter.

At the end of each event, EGSC Recruiters must clean and disinfect equipment before storing.

1. Clean hard surfaces (multiple times a day)- alcohol wipes of at least 70% will be provided.
2. Clean electronics such as tablets, touch screens, keyboards, mouse, and other objects used. Typically, alcohol-based wipes or sprays containing at least 70% alcohol can be used on electronics. (Advice will be sought by I.T.).

Furthermore, to limit physical recruiting as much as possible, the Office of Admissions plans to utilize unique recruiting methods to stay visible in the community.

1) Make continuous phone contact with prospecting students using the Communication Plan established by the Office of Admissions. The communications sent by the Office of Admissions will encourage all documentation to be submitted electronically to documents@ega.edu.

2) Purposefully outreach to the counselors of pipeline high schools- use Qlink to the Recruiters' advantages.

3) Utilizing social networking sites- Social media platforms like LinkedIn, Facebook, Twitter, Instagram, and Snapchat are fast and simple tools that can connect recruiters to high school counselors and/or high school students. Each platform offers a unique feature that gives access to an expansive network of profiles. LinkedIn, for example, has filters that allow you to find potential students according to their location. You can also use these platforms to advertise EGSC and increase engagement.

4) Participate in online forums- Searching for online communities on Reddit and/or Quora for discussion threads in the area. This is a great tool to recruit non-traditional students and target specific groups to recruit for the BSN or FESA program.

5) On-campus tours will be limited to five people in the group (including Recruiter). Open House will be schedule virtually. Before any event is declared in-person all stakeholding departments will meet to decide on procedures to best comply with social distancing and other adjustments as deemed necessary to ensure the physical event is in compliance to USG policies.

6) EGSC Campus tours have been designed with social distancing and additional adjustments as deemed necessary to remain in compliance with institutional and USG policies.

7) Effectiveness of EGSC Recruitment Strategies will be measured three fold: 1) Conversion rate of inquiries to applications; 2) Conversion rate of partial applications to completed applications (decision rendered); 3) Conversion rate of completed application to matriculation (student enrolled). Each of these categories will be compared to a three year data trend.

[Above list modified 7/11/2020]

Accuplacer Testing

ACCUPLACER testing is used for placement purposes to determine whether learning support courses are needed. Students with a non-STEM major have the option to take the ACCUPLACER to exempt learning support placement if valid SAT/ACT scores are not provided and/or students do not meet the minimum high school GPA threshold to exempt learning support. Students with a STEM major are required to take the ACCUPLACER if valid SAT/ACT score are not provided and/or if students do not meet the minimum high school GPA threshold to exempt learning support.

To best provide an opportunity for students to begin in the proper level gateway courses, especially for those students who are declared as being a STEM major and trying to gain admissions as Dual Enrollment, the ACCUPLACER needs to be an option for students whether it being administered on-campus, at another USG institution or through Examity (online test proctoring service).

On-campus Testing

Prior to the pandemic, the EGSC Admissions Office administered the ACCUPLACER on-campus to multiple students in small testing computer labs that range between 50 - 100 square feet. The lab in Swainsboro contains nine testing stations, in Statesboro four testing stations, and in Augusta ten testing stations that include a computer, keyboard, mouse, and seat. Before the pandemic of COVID-19 these testing centers were adequate to administer ACCUPLACER testing. Now, these small testing labs may be considered inadequate because of the square footage and layout of the testing lab. Even if plexiglass divider were installed between each tester being 6' apart during testing, the social distancing guideline would be violated because of the entering and exiting path of the computer lab. This prevents staff from practicing social distancing effectively and it leads students in an area that is not deemed safe by current health standards. Therefore, the labs are not an adequate area to allow testing of the ACCUPLACER for multiple students safely until health regulations deem it as adequate.

Furthermore, the EGSC Admissions Office testing procedures allowed walk-in testing, however, due to the current pandemic walk-in testing has been suspended for summer semester. Beginning in Fall Semester 2020, all on-campus testing will require students to sign up for specific on-campus testing dates via Eventbrite, pending if an EGSC site is open to students.

Eventbrite is the online programming software used by EGSC to allow students to register for any given EGSC event. A link will be provided to students to allow them to sign up for the posted ACCUPLACER testing dates. A limited number of testing spots are available per testing location.

As part of the registration process, EGSC will make at-risk students aware of the social distancing requiring and remote testing alternatives.

Instructions will be provided to each registered tester to meet at a specific location for each instructional site so they may be escorted to the testing area.

1. Swainsboro- Office of Admissions
2. Statesboro- EGSC Administrative Front Desk
3. Augusta- Galloway Hall Room 201 (subject to change)

To continue to provide the best on-campus ACCUPLACER testing services as possible, the Office of Admissions is proposing the following on-campus testing protocol for each site below:

Swainsboro

1. Six individuals will be allowed to test on the Swainsboro site during each testing session.
2. Testing will be conducted on every Monday and Friday, unless indicated otherwise (subject to change).

3. Classroom/Computer lab J531 will be utilized because it provides adequate spacing for individuals to practice social distancing as recommended by the CDC. The classroom is available from 1:00 p.m. - 5:00 p.m. according to the EGSC Facility Schedule.
4. The testing administrator is required to wear a protective face covering meeting CDC standards when interacting with individuals planning to test.
5. The testing administrator is strongly encouraged to wash hands frequently and thoroughly with soap and water and/or hand sanitizer, especially after touching common shared objects like doorknob, pens, telephone, etc.
6. All individuals must not handshake, high five, or hug. All individuals must comply with social distancing standards.
7. The testing administrator will escort the group with social distancing in mind to the testing area. When the group arrives to the testing area, the testing administrator will escort one individual at a time into the testing area and sit them in a predetermined testing computer that is separated 6' or more from other testing computers. Everyone that is escorted into the testing area will be provided hand sanitizer to sanitize his/her hands prior to touching any equipment.
9. Once all testers are sitting, the testing administrator will inform the students of the testing procedures from start to begin.
10. All students will begin the exam together.
11. When a tester finishes testing, the student is provided hand sanitizer, informed that his/her test scores will be downloaded within 72 business operating hours, and dismissed from the testing area.
12. After all testing is concluded, the testing administrator will be charged to disinfect each computer, its components, seats, doorknobs, and other items that may have been touched.

Statesboro

1. Six individuals will be allowed to test on the Statesboro site during each testing session.
2. Testing will be conducted on every Friday, unless indicated otherwise (subject to change).
3. Computer lab H134 or a classroom equipped with computers (e.g. H133, H135) will be utilized because the classroom provides adequate spacing for individuals to practice social distancing as recommended by the CDC. The

classroom/computer lab is available from 1:00 p.m. - 5:00 p.m. according to the EGSC Facility Schedule currently.

4. The testing administrator is required to wear a protective face covering as required by the above USG directive when interacting with individuals planning to test.
5. The testing administrator is strongly encouraged to wash hands frequently and thoroughly with soap and water and/or hand sanitizer, especially after touching common shared objects like doorknob, pens, telephone, etc.
6. All individuals must not handshake, high five, or hug. All individuals are required to comply with social distancing standards.
7. The testing administrator will escort each individual tester as they come onto campus into the testing area.
8. The testing administrator will escort one individual at a time into the testing area and sit them in a predetermined testing computer that is separated 6' or more from other testing computers. Everyone that is escorted into the testing area will be provided hand sanitizer to sanitizer his/her hands prior to touching any equipment.
9. Once all testers are sitting, the testing administrator will inform the students of the testing procedures from start to begin.
10. All students will begin the exam together.
11. When a tester finishes testing, the student is provided hand sanitizer, informed that his/her test scores will be downloaded within 72 business operating hours, and dismissed from the testing area.
12. After all testing is concluded, the testing administrator will be charged to disinfect each computer, its components, seats, doorknobs, and other items that may have been touched.

Augusta

1. Four individuals will be allowed to test on the Augusta site during each testing session.
2. Testing will be conducted on every Friday, unless indicated otherwise (subject to change).
3. The ACE Center in Galloway Hall (Rm. 208), or a computer lab, provided by AU Classroom Scheduling, will be utilized because the classroom provides adequate spacing for individuals to practice social distancing as recommended by the CDC.

The classroom/computer lab is available from 1:00 p.m. - 5:00 p.m. according to the EGSC Facility Schedule.

4. The testing administrator is required to wear a protective face covering as outlined by the above USG directive when interacting with individuals planning to test.
5. The testing administrator is strongly encouraged to wash hands frequently and thoroughly with soap and water and/or hand sanitizer, especially after touching common shared objects like doorknob, pens, telephone, etc.
6. All individuals must not handshake, high five, or hug. All individuals must comply with social distancing standards.
7. The testing administrator will escort the group with social distancing in mind to the testing area. Each tester will have temperature recorded prior to being escorted towards testing area by testing administrator. Any individual running a fever, based on CDC regulations, will be asked to leave the campus, and reschedule for a later testing date.
8. When the group arrives to the testing area, the testing administrator will escort one individual at a time into the testing area and sit them in a predetermined testing computer that is separated 6' or more from other testing computers. Everyone that is escorted into the testing area will be provided hand sanitizer to sanitizer his/her hands prior to touching any equipment.
9. Once all testers are sitting, the testing administrator will inform the students of the testing procedures from start to begin.
10. All students will begin the exam together.
11. When a tester finishes testing, the student is provided hand sanitizer, informed that his/her test scores will be downloaded within 72 business operating hours, and dismissed from the testing area.
12. After all testing is concluded, the testing administrator will be charged to disinfect each computer, its components, seats, doorknobs, and other items that may have been touched.

Remote Testing at other Institutions (if permitted by other institutions)

With the Remote Testing Option, students can quickly and conveniently arrange to have the Accuplacer exam administered from accredited testing centers across the country. Remote testing is arranged for students 50 miles or more from an EGSC campus. If a student tests at other institutions the student is subject to each institution's proctoring fee, which for this service the student will be responsible for. If a student chooses to set up a remote test, they are then required to fill out the Accuplacer Remote Testing Form found at

http://www.ega.edu/admissions/exam/accuplacer_remote_testing.

If the student is permitted the student must abide by all health and safety protocols at the institution where they are testing.

Examity Online Testing

Examity is an online proctoring platform that gives testers the flexibility to take exams remotely. Students must have a computer running Windows or Mac OS, a web cam, microphone, and high-speed internet connection. Furthermore, they will also need to create an account with Examity.

Examity is available 24/7 to EGSC students. Students taking Accuplacer online through Examity must pay \$20 for proctoring services. Students will pay Examity directly through the Examity website.

If the student pursues testing remotely online through Examity, they must complete the Accuplacer Remote Request Examity form located at

http://www.ega.edu/admissions/exam/accuplacer_remote_testing.

After the form is submitted, Admissions will create an Accuplacer voucher for the student. The voucher code and instructions to sign up for the test will be emailed to the student.

Open House and Outreach Events

All Open House and outreach events previously scheduled through July 2020 are moved to a completely virtual format. Upon reopening, the next Open House and Outreach events for each site during Spring and Summer Semesters 2021 will not occur until a modified format is considered for each site: Swainsboro, Statesboro, and Augusta

New Student Orientation

All Orientation program that had been previously schedule through the end of July 2020 are moved to a completely virtual format. All new students are required to complete the orientation process:

1. Watch the Orientation presentation
2. Submit an Orientation completion form, which verifies that they understand what is required of them as an EGSC student.
3. Submit a Registration survey, to put a student on a “list” to be registered as a student. On April 22, 2020 and on each consecutive Wednesday, a group of staff/faculty academic advisors register approved students, matriculating them as EGSC students. Each student receives an email with their schedule at their personal and EGSC account. Any students not “approved” to be on the “list” will be contacted to expedite the applicant’s process in the Admissions funnel.

Upon re-opening, the next Orientations for Spring and Summer Semesters 2021 will not occur until December 2020 in a modified format and consider any or all the following:

- Upon re-opening, the next Orientations for Spring and Summer Semesters 2021 will continue to be an online format only.

[Paragraph Revised 7-11-2020]

Co-Curricular Retention

The Co-Curricular Retention strategies are included in the Academic and Research sections pages 39-47,

[Paragraph revised 7-11-2020]

Contingency Plan 2 – Fall classes begin fully online

Admissions Operations

Daily Office Strategies

Typically, the EGSC Office of Admissions has a great deal of physical interaction with students, parents, staff, faculty, and guests. To best prepare a safe and healthy environment the Office of Admissions is proposing to put forth the following implementations for Contingency Plan 2.

Hours of Operations

- Monday – Friday 8:00 a.m. to 5:00 p.m. (subject to change) (Admissions entry ways will remain locked to human traffic unless individuals are otherwise approved to enter).

Staff (Personnel) Scheduling

- Monday – Friday 8:00 a.m. to 5:00 p.m. (subject to change based on operation hours)

All personnel of the Office of Admissions must follow the health guidelines established for safety.

1. Required to wear protective face covering, as provided by the above USG directive, when interacting with others
2. Strongly encouraged to wash hands frequently and thoroughly with soap and water and/or hand sanitizer, especially after touching common shared objects like doorknob, pens, telephone, etc.
3. Do not handshake, high five, or hug.

4. Cover your cough or sneeze. Use a tissue, your elbow, or inside shirt. Immediately discard any tissue you may have used or disinfect any area of your body with soap and water or sanitizer.
5. Avoid touching your face, eyes, or mouth.
6. Follow social distancing standards.
7. Be aware of your surroundings and conscious of your movements, remain at social distancing recommendations.
8. Remain in personal office space as often as possible

Supervisors will reinforce behaviors, and ensure there is transparency of actions and situations, as in similar leadership methods within health and safety. This means cleanliness conversations and reviews.

With this said, the Office of Admissions plans to adopt a cleaning and disinfecting procedure. Each staff member will play their role in maintaining a safe and healthy environment so people can be assured.

1. Clean and disinfect hard surfaces after use (multiple times a day)- alcohol wipes of at least 70% will be provided to each staff member.
2. Cleaning and disinfecting of electronics such as tablets, touch screens, keyboards, mouse, and other machines that are used. Typically, alcohol-based wipes or sprays containing at least 70% alcohol can be used on electronics. (Advice will be sought by I.T.).

Recruitment Strategies

Typically, the EGSC Recruiter is physically attending recruitment events and interacting personally with high school counselors and students. The nature of attending high school events changes from school to school and changes regularly. However, if EGSC is required to follow Contingency Plan 2, all physical recruiting will be suspended.

To continue recruitment, the Office of Admissions plans to utilize unique recruiting methods to stay visible in the community.

- 1) Make continuous phone contact with prospecting students using the Communication Plan established by the Office of Admissions. The communications sent by the Office of Admissions will encourage all documentation to be submitted electronically to documents@ega.edu.
- 2) Purposefully outreach to the counselors of pipeline high schools- use Qlink to the Recruiters' advantages.
- 3) Utilizing social networking sites- Social media platforms like LinkedIn, Facebook, Twitter, Instagram, and Snapchat are fast and simple tools that can connect recruiters to high school counselors and/or high school students. Each platform offers a unique feature that gives access to an expansive

network of profiles. LinkedIn, for example, has filters that allow you to find potential students according to their location. You can also use these platforms to advertise EGSC and increase engagement.

4) Participate in online forums- Searching for online communities on Reddit and/or Quora for discussion threads in the area. This is a great tool to recruit non-traditional students and target specific groups to recruit for the BSN or FESA program.

5) On-campus tours will be limited to five people in the group (including Recruiter). Open House will be schedule virtually. Before any event is declared in-person all stakeholding departments will meet to decide on procedures to best comply with social distancing and other adjustments as deemed necessary to ensure the physical event is in compliance to USG policies.

6) EGSC Campus tours have been designed with social distancing and additional adjustments as deemed necessary to remain in compliance with institutional and USG policies.

7) Effectiveness of EGSC Recruitment Strategies will be measured three fold: 1) Conversion rate of inquiries to applications; 2) Conversion rate of partial applications to completed applications (decision rendered); 3) Conversion rate of completed application to matriculation (student enrolled). Each of these categories will be compared to a three year data trend.

In addition to, recruiters will be required to assist in daily operations of processing and transitioning students through the Admissions funnel.

[Above list modified 7-11-2020]

Accuplacer Testing

ACCUPLACER testing is used for placement purposes to determine whether learning support courses are needed. Students with a non-STEM major have the option to take the ACCUPLACER to exempt learning support placement if valid SAT/ACT scores are not provided and/or students do not meet the minimum high school GPA threshold to exempt learning support. Students with a STEM major are required to take the ACCUPLACER if valid SAT/ACT score are not provided and/or if students do not meet the minimum high school GPA threshold to exempt learning support.

To best provide an opportunity for students to begin in the proper level gateway courses, especially for those students who are declared as being a STEM major and trying to gain admissions as Dual Enrollment, if EGSC is required to follow Contingency Plan 2, the ACCUPLACER will be offered through Examity (online test proctoring service) pending the company's availability.

Examity Online Testing

Examity is an online proctoring platform that gives testers the flexibility to take exams remotely. Students must have a computer running Windows or Mac OS, a web cam, microphone, and high-speed internet connection. Furthermore, they will also need to create an account with Examity.

Examity is available 24/7 to EGSC students. Students taking Accuplacer online through Examity must pay \$20 for proctoring services. Students will pay Examity directly through the Examity website.

If the student pursues testing remotely online through Examity, they must complete the Accuplacer Remote Request Examity form located at

http://www.ega.edu/admissions/exam/accuplacer_remote_testing.

After the form is submitted, Admissions will create an Accuplacer voucher for the student. The voucher code and instructions to sign up for the test will be emailed to the student.

Open House and Outreach Events

All Open House and outreach events will be moved to a completely virtual format. A modified format will be considered for each site: Swainsboro, Statesboro, and Augusta.

New Student Orientation

All Orientation programs will be moved to a completely virtual format. All new students are required to complete the orientation process:

Watch the Orientation presentation.

Submit an Orientation completion form, which verifies that they understand what is required of them as an EGSC student.

Submit a Registration survey, to put a student on a “list” to be registered as a student. On April 22, 2020 and on each consecutive Wednesday, a group of staff/faculty academic advisors register approved students, matriculating them as EGSC students. Each student receives an email with their schedule at their personal and EGSC account. Any students not “approved” to be on the “list” will be contacted to expedite the applicant’s process in the Admissions funnel.

Upon re-opening, the next Orientations for future semesters will continue to be an online format.

[Above sentence revised 7-11-2020]

Contingency Plan 3 – Classes and operations must go to an online format for a period during the semester

Admissions Operations

Daily Office Strategies-

Typically, the EGSC Office of Admissions has a great deal of physical interaction with students, parents, staff, faculty, and guests. To best prepare a safe and healthy environment the Office of Admissions is proposing to put forth the following implementations for Contingency Plan 3.

Hours of Operations

- Monday – Friday 8:00 a.m. to 5:00 p.m. (All staff will work remotely)

Staff (Personnel) Scheduling

- Staff will be required to remote into EGSC network.
- Staff will be required to provide proof of work.

All personnel of the Office of Admissions are recommended to follow the health guidelines established for safety while working in residence.

1. Strongly encouraged to wear protective face covering when interacting with others, if staff member must leave residence at any time.
2. Strongly encouraged to wash hands frequently and thoroughly with soap and water and/or hand sanitizer, especially after touching common shared objects like doorknob, pens, telephone, etc.
3. Do not handshake, high five, or hug with anyone.
4. Cover your cough or sneeze. Use a tissue, your elbow, or inside shirt. Immediately discard any tissue you may have used or disinfect any area of your body with soap and water or sanitizer.
5. Avoid touching your face, eyes, or mouth.
6. Comply with social distancing standards.
7. Be aware of your surroundings and conscious of your movements, remain at social distancing recommendations.
8. Clean and disinfect hard surfaces after use (multiple times a day)- alcohol wipes of at least 70% will be provided to each staff member.
9. Cleaning and disinfecting of electronics such as tablets, touch screens, keyboards, mouse, and other machines that are used. Typically, alcohol-based wipes or sprays containing at least 70% alcohol can be used on electronics. (Advice will be sought by I.T.).

Recruitment Strategies

Typically, the EGSC Recruiter is physically attending recruitment events and interacting personally with high school counselors and students. The nature of attending high school events changes from school to school and changes regularly. However, if EGSC is required to follow Contingency Plan 3, all physical recruiting will be suspended.

To continue recruitment, the Office of Admissions plans to utilize unique recruiting methods to stay visible in the community.

- 1) Make continuous phone contact with prospecting students using the Communication Plan established by the Office of Admissions.
- 2) Purposefully outreach to the counselors of pipeline high schools- use Qlink to the Recruiters' advantages.
- 3) Utilizing social networking sites- Social media platforms like LinkedIn, Facebook, Twitter, Instagram, and Snapchat are fast and simple tools that can connect recruiters to high school counselors and/or high school students. Each platform offers a unique feature that gives access to an expansive network of profiles. LinkedIn, for example, has filters that allow you to find potential students according to their location. You can also use these platforms to advertise EGSC and increase engagement.
- 4) Participate in online forums- Searching for online communities on Reddit and/or Quora for discussion threads in the area. This is a great tool to recruit non-traditional students and target specific groups to recruit for the BSN or FESA program.
- 6) Host virtual tours and Open House.
- 7) Effectiveness of EGSC Recruitment Strategies will be measured three fold: 1) Conversion rate of inquiries to applications; 2) Conversion rate of partial applications to completed applications (decision rendered); 3) Conversion rate of completed application to matriculation (student enrolled). Each of these categories will be compared to a three year data trend.

[Above list modified 7-11-2020]

In addition to, recruiters will be required to assist in daily operations of processing and transitioning students through the Admissions funnel.

Accuplacer Testing

ACCUPLACER testing is used for placement purposes to determine whether learning support courses are needed. Students with a non-STEM major have the option to take the ACCUPLACER to exempt learning support placement if valid SAT/ACT scores are not provided and/or students do not meet the minimum high school GPA threshold to exempt learning support. Students with a STEM major are required to take the ACCUPLACER if valid SAT/ACT score are not provided and/or if students do not meet the minimum high school GPA threshold to exempt learning support.

To best provide an opportunity for students to begin in the proper level gateway courses, especially for those students who are declared as being a STEM major and trying to gain admissions as Dual Enrollment, if EGSC is required to follow Contingency Plan 2, the ACCUPLACER will be offered through Examyty (online test proctoring service) pending the company's availability.

Examyty Online Testing

Examity is an online proctoring platform that gives testers the flexibility to take exams remotely. Students must have a computer running Windows or Mac OS, a web cam, microphone, and high-speed internet connection. Furthermore, they will also need to create an account with Examity.

Examity is available 24/7 to EGSC students. Students taking Accuplacer online through Examity must pay \$20 for proctoring services. Students will pay Examity directly through the Examity website.

If the student pursues testing remotely online through Examity, they must complete the Accuplacer Remote Request Examity form located at

http://www.ega.edu/admissions/exam/accuplacer_remote_testing.

After the form is submitted, Admissions will create an Accuplacer voucher for the student. The voucher code and instructions to sign up for the test will be emailed to the student.

Open House and Outreach Events

All Open House and outreach events will be moved to a completely virtual format. A modified format will be considered for each site: Swainsboro, Statesboro, and Augusta

New Student Orientation

All Orientation programs will be moved to a completely virtual format. All new students are required to complete the orientation process:

Watch the Orientation presentation

Submit an Orientation completion form, which verifies that they understand what is required of them as an EGSC student.

Submit a Registration survey, to put a student on a “list” to be registered as a student. On April 22, 2020 and on each consecutive Wednesday, a group of staff/faculty academic advisors register approved students, matriculating them as EGSC students. Each student receives an email with their schedule at their personal and EGSC account. Any students not “approved” to be on the “list” will be contacted to expedite the applicant’s process in the Admissions funnel.

Upon re-opening, the next Orientations for future semesters will continue to be an online format.

[Above paragraph revised 7-11-2020]

Registrar’s Office

Contingency Plan 1 (Fall Classes Begin with Social Distancing Expectations)

Registration

Access to forms

- We have been working since mid- March 2020 to make all registrar forms electronic and an easy submission for students/faculty/staff. This information has been communicated to students via email by the Registrar’s Office. This continues to be an ongoing project prioritized by forms that are most frequently used.

Creating contactless drop off

- Make available paper forms (as needed) to students outside of the Registrar’s office.
- Once completed by students, they can drop the form off at the drop off window in Enrollment Management.
- Provide posted directions of “next steps” (pick up and/or mailing dates, times, etc.) for students near forms along with contact information to the registrar’s office should they have questions or concerns.
- Keeping students/faculty/staff informed via email communications.
- Virtual meetings- The registrar’s office is ordering webcams for those who may not feel comfortable coming into the office but still would like to see and know who they are communicating with for assistance.
- Live chat via EGSC website.

Face to Face service

- Limited seating in the Office waiting area with adequate spacing between customers.
- Ensuring staff is cleaning and disinfecting areas at the start of each workday, after each visit, and at the end of each workday.
- Having (desk) Sanitizer available in each office for students/staff/faculty.
- Create a quicker “In and Out” experience for students possibly getting their information prior to meeting face to face or at the EM drop off window so that we can be better prepared to resolve their issue once they meet with record’s personnel.
- Live Chat via web.
- Utilizing Protective face covering.
- Records Personnel will communicate via email, teams, etc. to each other and various departments in the institution. Limit face to face meetings.

Contingency Plan 2 and 3

Face to face service will cease.

With the current experience the registrar’s office has gained in working remotely, we are prepared to continue responding to emails and phone calls. We will also live chat (zoom) to provide a personal touch.

Office of Student Financial Aid

Contingency Plan 1 (Fall Semester 2020 Classes Begin with Social Distancing Expectations)

Financial Aid Operations

Staffing

Upon notification that the campus will re-open, the financial aid office will begin to shift its workforce back to campus as follows:

- During the two-week prep period the office will be open to staff Monday through Thursday, 8am to 5pm.
- The Director and Assistant Director will perform regular daily tasks and assess and implement the physical and procedural needs of re-opening the office.
- Two financial aid processors will return to campus to perform their daily tasks and help simulate open office practices, assess effectiveness, and aid the Director and Assistant Director in modifying procedures to ensure safety of both students and staff.
- The remaining two financial aid processors will continue to work remotely, as they are both in a high-risk category per CDC guidelines. Job duties may be re-evaluated and altered as necessary for the most efficient operation of the office.
- Upon re-opening, office staffing levels will remain the Director, Assistant Director, and two processors. The other two processors will remain working remotely.
- FA staffing of external campuses that began during the 2019-2020 academic year will be temporarily suspended during this emergency period, but we will implement video conferencing at each site to assist in continuity of service to all EGSC students.

Preventative Practices

As mentioned above, at-risk staff will continue to work remotely. Job responsibilities may change to best accommodate the needs of the office.

Social distancing will be accomplished by a variety of initiatives:

- A shield will be requested and installed at the front service counter.
- Video cameras/microphones have been ordered for all Financial Aid staff to allow for administrative meetings and for enhanced student/parent counseling (hence reducing in office traffic).
- A paging system is being researched to enable appointments and walk up traffic to be put into a queue and notified when a staff member is available to be seen. This will eliminate the need for students to congregate in a waiting room in the office.
- Only the student and one parent of a dependent student will be allowed in the office for counseling sessions. Additional family members and friends will be asked to wait outside the financial aid office.

- Depending on staffing and office configurations, students may be advised of the necessity to use video conferencing for their appointments in lieu of face to face meetings, due to social distancing mandates.

Additional preventative practices include:

- Staff will be provided with a supply of disinfectant wipes for their offices.
- Students have a personal responsibility to have a face covering upon entering the office, to help protect staff and other students in the office. If they do not have a face covering, they will be refused entrance.
- Hand sanitizer is currently available at the entrance to the office. Additional hand sanitizer will be available for each staff members' desk.

Additional practices will be developed during the pre-opening staff assessment period, as the department simulates daily office activity.

Mitigation and Monitoring

The Financial Aid Office will work with its high-risk staff to continue working from home. Staff not designated as high-risk will work on-campus and practice social distancing as described above.

All staff will be made aware of institutional policies and practices regarding:

- Employees becoming symptomatic or testing positive for COVID-19
- Other staff becoming symptomatic or testing positive for COVID-19
- Institutional health care availability and partnerships to provide healthcare
- Required isolation for students, faculty, and staff

Cleaning and Disinfecting Practices

Face coverings are the personal responsibility of each staff member. Hand sanitizer and disinfectant wipes will be provided to each staff member.

It is the responsibility of each staff member to clean and disinfect their personal workspace regularly. The Financial Aid Office will defer to the college for cleaning and sanitation practices for all common areas and nightly office cleaning and disinfecting.

Travel

The only travel authorized for any Financial Aid staff will be to and from our extended campuses (EGSC Augusta and EGSC Statesboro). All other business-related travel will be suspended until it is deemed safe to do so by the USG. Required training and conferences will be done via electronic means.

The Financial Aid office will work with the Admissions Office to define its role in a revised orientation process.

Using Technology to Process Student Aid:

- Webcams with microphones have been ordered for each FA staff member's office computer. This will allow staff to engage in video meetings with students and parents, reducing the need for in office visits and assisting with social distancing.
- The financial aid office is in the process of scheduling group zoom meetings centered around specific topics that students and parents can sign up for/participate in to troubleshoot difficult areas of the financial aid process. Current proposed topics are;
 - FAFSA Completion
 - Verification
 - SAP/Appeals Process
 - Awarding/Disbursement/Refund Process
- We are researching texting and/or paging system to notify visitors when and advisor is available. The objective is to keep visitors outside of the office until ready to be seen – no in-office waiting room.

Financial Aid leadership will assess the effectiveness of the current remote processing system and make modifications as needed with consideration to staffing requirements (maintaining high risk staff in a remote environment while bringing others back on campus).

Outcomes for financial aid will best be measured by its ability to stay current with application processing as form come into the office, measuring outstanding awards to be made, and measuring incomplete verifications and files requiring additional documentation.

One obstacle we are currently aware of is the state legislature not passing a budget to enable GSFC to establish amounts for state aid (HOPE and Zell Miller Scholarships).

Contingency Plan 2 and 3

Financial Aid Operations

With the current experience the financial aid office has gained in working remotely, we are prepared to continue processing student aid files and responding to emails and phone calls. We are currently putting together zoom workshops on helpful topics.

Additional technologies that will be used to help in communicating with students is the state's uniform Offer Letters that not only inform students what financial aid they qualify for, but link to additional information, including the school's website and helpful financial aid videos.

EGSC Enrollment Plan

Scholarship offered during admission process

Applicants are only allowed to receive one *Trigger Award*. These scholarships are presented by the admission office and awarded by the financial aid office when accepted.

- Presidential Scholarship:** \$500.00 for commuter students based on SAT/ACT or HS GPA
SAT 480/440 or 2.75 HSGPA
- Foundation Scholarship:** \$1,000 for dorm students based on SAT/ACT or HS GPA
SAT 480/440 or 2.75 HSGPA
- Leadership Scholarship:** *New criteria being developed*
- Correll Scholarship:** Full Tuition (awarded by the Correll Committee)

Financial Need Awards: Scholarship based on financial need as determined by the financial aid office after all outside aid is determined. (parent plus denial included)

Gambrell Scholarship: \$250 - \$1,000 to meet financial need

At least 15% of the general scholarship budget will be retained for financial need after the start of the fall term.

Admission Pools: Driven by Tactics and Strategies

Recruit Back:

- 1) Applicants that did not enroll from the previous 2 *enrollment cycle*.
- 2) Students whose probation period is over. (60-mile radius of all campuses)
- 3) Students who dropped out from the previous 2 *enrollment cycle*.

Returning students:

- 1) Students eligible to return from previous enrollment semester. (always includes recent summer semester)
- 2) Students needs to appeal to return from previous enrollment semester.

Prospects:

- 1) Bought contacts (example: SAT) or recommended contacts (Example: Alumni referrals)
- 2) GSU and ASU denied list

Inquires:

- 1) Contact information obtain from a potential student/parent. (Examples: partial applications, marketing, emails, cards completed, FASA but no app, SAT/ACT arrived but no app.)

Applications

- 1) Sorted by SAT, High School GPA, and Major.
- 2) Late applications or FASFA (4 to 6 weeks before semester starts push to late term).

Registered

- 1) Sorted by SAT, High School GPA, and Major.

Action Groups for Action Plans as Needed

Below are call groups that may be activated to address call campaigns as needed.

- 1) Housing Staff
- 2) Student Affairs Staff
- 3) Admission Staff
- 4) Augusta Support Staff
- 5) Statesboro Support Staff
- 6) Faculty: Program Coordinators
- 7) Faculty: Math and Science Division
- 8) Faculty: Humanities and Social Science Division
- 9) Library Staff
- 10) Admissions Staff

Tactics Applied to Pools

- 1) Mongoose (texting program)
- 2) Phone Call Campaigns
- 3) Emails
- 4) Postcards
- 5) Social Media
- 6) Radio Ads
- 7) Tri-fold Brochure mailings
- 8) Letters

Strategies for Impacting Enrollment

- 1) Trigger awards targeting prospects and inquiries.
- 2) 12-week later term for fall targeting applications submitted 4 weeks before school starts
- 3) Fall break term (Christmas Break)
- 4) Targeting early fall applications (Nov – Dec) with competitive cost campaign. Maybe Scholarship Offerings.
- 5) Targeting Home School students for (on-line) dual enrollment and traditional fall enrollment through SAT/ACT purchase
- 6) Denied Students from GaSouU and AU

7) Marketing Social Media Campaign geo-targeted. Budgeted \$100,000.

Funnel Communication Plan

(messaging will target summer/fall 2020)

Inquiries: Conversion Messaging

Week 1

Mongoose: "Inquiry Conversion Message" Text to all current inquires

Purpose: Generate Call List for week 2

Email: "How to Apply Message"

Purpose: Drive to Apply

Week 2

Phone Call: "How to Apply Script" and FAQ Guide for conversation

Purpose: Drive to apply

Post Card: "Competitive Cost Message"

Purpose: Drive to apply

#Repeat sequence until July 15, 2020

Applicants: Acceptance Messaging

Week 1

Post Card: "Reasons to Choose EGSC"

Purpose: Drive to Acceptance/Missing Docs

Week 2

Mongoose: "Interest Level Message"

Purpose: Generate Call List (week 3) and Cancel Applicants not Interested

Week 3

Phone Call: "Complete Admissions Process"

Purpose: Driving Acceptance Rate

Mongoose: “What are your plans? Sent to canceled files

Purpose: Identify Competition – help create an opposing message

#Repeat Sequence until July 15, 2020

Accepted Applicants: Yield Rate Messaging

Week 1

Post Card: “EGSC Student Life”

Purpose: Drive to Registering

Week 2

Mongoose: “Interest Level Message for registering”

Purpose: Generate Call List (week 3) and Cancel Applicants not Interested

Email: “Orientation Sign Up and Registering

Purpose: Drive Yield Rate

Week 3

Phone Call: “Orientation and Registration Process”

Purpose: Driving Yield Rate

Mongoose: “What are your plans? Sent to canceled Applications

Purpose: Identify Competition – help create an opposing message

Enrollment Action Plans to be Implemented

EGSC needs to generate inquires and applications for Fall Semester 2020 from a variety of target populations. Enrollment action plans will require specific marketing messages and new academic sessions (example fall break term) to support enrollment growth. The “working” outline and summary of initiatives are detailed below.

Commuters: All Three Campuses

1) Mailing /emailing to applications from 2019 and 2018

- a. Marketing: Post card, email, and landing page
- b. Input Results into Communication Plan Cycle

2) Prospect Push: SAT/ACT purchase for commuter range: low – 1250.

- a. Marketing: Post card, email, and landing page
- b. Message: personable, cost saving, and Professors that teach
- c. Input Results into Communication Plan Cycle

3) Prospective Marketing: Social Media and Radio for target area

- a. Drive to landing page (message: personable, cost saving, and Professors)
- b. Input Results into Communication Plan Cycle

4) SAT/ACT purchase for service range (low to 1250) and target counties

- a. Trigger awards to increase inquires to applicant yield. (enrolled)
- b. Message: personable, cost saving, and Professors that teach
- c. Input Results into Communication Plan Cycle

5) Dual Enrollment Strategies

- a) SAT/ACT Purchase to target Home Schooled students across the state
- b) Marketing: Post card for mailing and landing page on web
- c) Contact Home School Groups in GA (outside state?)

New Academic Scheduling

Late Session Start 12 Week

- 1) In previous fall semesters at EGSC 11% of first-time freshman applicants that attended applied 4 weeks before school started. These students averaged less than a 2.0 GPA. A late term start should yield a higher yield rate of late applicants and improves academic success. Through marketing the applicant pool should also increase in size.

Fall Break Term (Pilot Term was 2019)

- 1) Expand to other colleges and universities targeting Athletic Advisors

ARCHIVED
The COVID-19 Public Health Emergency Declaration ended at midnight on May 11, 2023.
Information for archival use only.

6. Athletics

- Chuck Wimberly, Athletic Director/Head Coach for Women's Softball (Chair)
- Cliff Gay, VP for Business Affairs
- Angie Williams, Director of Event Planning and Scheduling

The following is the plan of the Athletics Sub-committee:

CONTINGENCY PLAN #1 – Fall Semester 2020 classes begin with social distancing expectations

Guiding Principles

- 1) NJCAA Directives that will come in JUNE 2020.
- 2) GCAA Directive to follow NJCAA Directives.
- 3) USG/EGSC Directives per Phases of Return to Campus.

EGSC Athletics The National Junior College Collegiate Athletic Association (NJCAA) on June 19th 2020 gave directive for Fall/Winter sports Return to Play for Junior College Athletics.

Colleges were provided Health and Safety Recommendations for Return to Play by the NJCAA in 3 separate handouts, along with start dates and end dates for Fall/Winter play for each individual sport.

The Georgia Collegiate Athletic Association (GCAA) followed the NJCAA directives in their meeting on June 23rd, 2020.

The USG Athletic Directors had a Zoom meeting with USG Representative, John Fuchko, on June 22nd 2020 to speak about Best Practices for Athletics in a round table meeting with all USG Athletic Directors cross the State of Georgia.

EGSC Athletic Department has developed a "Return to Play Action Plan" for our EGSC Athletic Staff, Trainers, Coaches, and Players to follow upon our return to Fall Semester.

This plan addresses the following:

- 1) Preparation for Return to Campus
- 2) Staff Return
- 3) Student Athlete Return
- 4) Return to Training
- 5) Return to Competition
- 6) Unconditional Buy-In from Athletes, Coaches, and Staff

"Return to Play" Action Plan for Fall 2020

The intent of this document is to assist our athletic department with preparation and implementation of strategies to enhance a safe return to campus, play, and athletic activities following the COVID-19 PANDEMIC.

1. PREPARATION FOR RETURN TO CAMPUS

A. CREATION OF ATHLETIC COVID-19 ACTION TEAM

LEROY JORDAN- Head Men's Basketball Coach
THEO HOWARD-Head Women's Basketball Coach
ERIC MCCOMBIE-Head Baseball Coach
CHARLES WIMBERLY-Athletic Director/Head Softball Coach
DENISE DANIELS-Eligibility/Athletic Compliance
HANNAH GOMEZ- Athletic Trainer
EMANUEL MEDICAL CENTER & EGSC Health Clinic

B. Campus General Council/Covid Task Force

- (Covid-19 Task Force Team is in place now at EGSC now, meet every Monday, and have been since March 2020. Athletic Director, Charles Wimberly is on Covid-19 Task Force for EGSC)
- (Athletic Director is on EGSC Cabinet and Senior Staff)
- (Athletic Director, Charles Wimberly, has had U.S. Army and USG training at Georgia College on Health and Safety measures for Colleges and Institutions due to the COVID-19 Pandemic. Training was on May 13th 2020)

C. Safe Transition to Athletic Activity

- (Athletic Orientation & Education Program on Health & Safety Pre-Cautions, Pre-Physical Exams, Physical Exams, Staggered Move-In to Dorms)
- (Require wearing of protective face coverings by players, staff, faculty, trainers and coaches, as provided by the above USG directive)

2. Staff Return

A. Staggered return of Athletic Staff

- (Already in Place for Summer with Coaches coming on different days of the week and times)

- (In the event a Head Coach were to have to be quarantined for 14 days, the volunteer assistant would take over during time that coach is quarantined or until medical clearance for return. In the event no volunteer assistant is place to take head coaches position, one of the other head coaches on staff for a different EGSC team will assume those duties.)
- (In the event the Athletic Director were to be quarantined for 14 days, the athletic compliance and eligibility officer would assume duties on-site while consulting with AD by email, text, etc., along with Head Coaches.)

B. Acquisition of Disinfectant Products

- (Order placed for protective face coverings, Thermometers, Gloves, Sanitizing Wipes, Disinfecting Spray. Ordered April 2020)

C. Pre-Participation Physicals

- (Already in Place for August 17th Physical Exams at EGSC Clinic, with staggered physical exams for social distancing in place for each individual exam. Each Player will present Pre-Physical Exam to Health Clinic before physical exams for any illness over summer 2020 to be documented)

D. EMS/911

- (Already in place with Emanuel Medical Center, Swainsboro, Ga and EGSC Clinic if needed)

E. Quarantine/Isolation

- (Players will be at this time required to go home if quarantined, and/or if dorms have housing for quarantining, we will use)

F. Protective Equipment

- (Order placed in April by EGSC per information sent to college by Athletic Director)

3. Student Athlete Return

A. Pre-Activity Screen

- (Student/Athletes will fill out pre-physical exam paperwork before Physical Exams beginning on August 17th)

B. Pre-Game and Practice Screen

- (In place with temperature checks and daily questionnaire, before each activity, travel or away games, with log-in-book to document daily checks, keep by each Head Coach)
 1. Do you currently have a fever of 100.4 degrees or higher?
 2. Do you have a persistent cough?
 3. Are you experiencing shortness of breath or chest tightness?
 4. Are you experiencing flu-like symptoms such as sore throat, diarrhea, extreme fatigue, muscle aches and/or headaches?
 5. Are you currently experiencing a loss of sense taste or smell?

*Athlete is responsible for sending this email or text to school official daily.

If answer is “Yes” to any, the athlete is not allowed to participate in any sanctioned activity.

Working on phone app for players to use to answer these above questions for each head coach prior to arriving before any practice and game days.

4. Return to Training

A. Equipment Sanitation

- (Plan in place with custodian staff and coaches to sanitize all equipment items before and after each practice and use, along with the purchase of items such as helmets, gloves, uniforms, etc for individual use by each player, so as to have no cross over of clothing items or equipment use. Training room, gym, locker rooms, fitness center, and PE complex will all be sanitized each day after use)

B. In-Game Processes

1. Visiting team is responsible for their own water
2. 1 person at pre-game meetings with umpires or referees
3. No pre-game or post-game handshakes
4. 6ft discussions with umpires or officials
5. Host team provide sanitation wipes and disinfecting sprays

C. EGSC Protocol for Players, Coaches, Staff

1. Each player will be responsible for bringing their own water or drink bottle to practices and games. We will provide each player with a NEW Powerade bottle for their use to take home each day for cleaning and their own use.
2. Designate one entrance and one exit for players, staff, and coaches to use daily.
3. Provide washable protective face coverings for athletes
4. Training room only 1 person allowed in at any one time. No hanging out, period!
5. Weight room only 5 people allowed in at one time with social distancing
6. Fitness center only 10 people allowed in at any one time with social distancing.
7. Softball and Baseball provide each athlete with their own helmet for batting.
8. Softball and baseball provide each athlete with their own batting gloves.

9. Basketball, home and visitor locker rooms and gym are cleaned after each contest and before another team is allowed in the following day.
10. Basketball, chairs are social distanced, with individual assigned seats for home /visitor players for each contest.

D. Team Ops and Travel

- (Temperature checks will be done before any players leave for travel on bus, 1 person per bed on travel games for overnight stays, one open seat between players on bus travel to ensure social distancing of 6 ft)

E. Spacing Considerations

- (No Fans for Fall Semester Games, Practices, Athletic Events, etc. We will live- stream games with Facebook live stream of games in Fall if possible. We as a staff of coaches agree that we should not have fans for fall semester 2020. We will review this action item for Spring 2020 semester.)
- 4 to 0 Vote 7/6/2020 by all Head Coaches in agreeing to not have Fans for 2020 Semester at Sporting Events at EGSC.
- (Provide spacing with designated seating for basketball players at games with social distancing, with baseball and softball players having bench seating outside dugouts, if dugouts are not large enough for ample social distancing)

F. Meals

- (No indoor sit-down meals, unless team is the only ones at facility with social distancing, suggest pick up meals, box lunches, pizza, or sack meals)
- NO EATING ON BUSES

5. Return to Competition

A. Contingency Plan for Managing Recurrence

- (On-Line Classes have been and are already in place at EGSC, even before the Covid-19 Pandemic, for students to be able to continue education process if no face to face class are allowed)

6. Unconditional buy-in from Athletes, Coaches, Medical Staff, and Athletic Department staff

A. Persistent and Continued Education

B. Expect Changes

C. Support Each Other

D. Education will be Key to All of our Success during the COVID-19 Pandemic

[Above revised 7-11-2020]

Action Steps to Carry Out this Plan

- 1) Require Temperature checks* of athletes, coaches, officials and staff, prior to practices and games. Practices would be recorded with a daily practice log.
- 2) Practices are closed practices with no outside attendance allowed without permission or checks, with prior approval from Athletic Director.
- 3) Game days prior to team departure, all players and traveling team personnel will have temperature checks.* This will be recorded with a Pass/Fail in order not to violate HIPA laws.
- 4) Home teams will also certify officials for games prior to contest.
- 5) Daily temperature check upon arrival to campus for each workday for athletic staff.
- 6) Temperature checks* for on-campus recruits and tryouts.
- 7) Custodial Staff and Coaches will ensure facility usage has been disinfected prior to and post competition.

Primary Responsibility and Timeline

- 1) Athletic Staff/Coaches have primary responsibility for each action step.
- 2) Prior to Practices, Games, Travel, Overnight Stays; prior to Fall Semester

Education of the EGSC community about this component of the campus plan?

(note: the communications plan below should address the communication techniques which will be used)

- 1) Athletic Director, Charles Wimberly, has completed COVID 19 Training presented by the USG and the U.S. ARMY at Georgia College.
- 2) Student/Athlete Orientation will have Information for Athletes on the health and safety precautions for themselves and others, per Athletic Director Charles Wimberly's training.

See, also, the plan of the Communications Sub-committee below.

Materials and supplies and equipment Needed

- 5 Infrared Thermometers*
- 12 Bucket Size Sanitizing Wipes
- 100 Outdoor Sports Protective face covering
- 12 Boxes of 100 Count Rubber Gloves
- 24 Clorox Disinfecting 19oz. Spray Cans
- 6 Purell Hand Sanitizing Stations for Dugouts, Gym and Locker Rooms

Notes to list of material/equipment needs:

- Delivery will be pending availability for all items.
- We have 4 Buckets Sanitizing Wipes, 2 Purell Hand Stations, Clorox Spray Cans on hand at present time.
- Not Sure if there will be a deficit, we will budget for a 6 way split of total amount to assure no high cost to any of the 5 athletic teams or department, along with fitness center, which would result in an added cost of \$ 384.00 per team, department and center if not covered by COVID-19 planned cost for institution as a whole.

*EGSC will provide temperature checks as recommended by NJCAA and GCAA. The EGSC Student Health Center will be consulted regularly for training and guidance concerning the appropriate procedures for use and care of the above thermometers. It is the responsibility of the Athletic department to perform checks, record results, and maintain records.

Status of Athletic Venues for Fall Semester 2020

Fitness Center – Open with a 10 person maximum of attendance at any given time, with social distancing of equipment already in place; disinfecting wipe stations for general public use after equipment is used is already in place; athletic and custodial personnel wiping down equipment regularly after use. Card Access will not be allowed at any time; hours of operation from 6am until 5pm daily, Monday thru Friday, closed Saturday and Sunday of each week.

- Locker Rooms – Athletic teams/Coaches Only
- Tennis Courts – Open to students, faculty, staff and community, with postings for social distancing.
- Running and walking trails – Open to students, faculty, staff and community, with postings for social distancing.
- Disc golf course - Open to students, faculty, staff and community, with postings for social distancing.
- Outdoor basketball courts - Open to students, faculty, staff and community.
- Gym – Open Gym will not be accessible Monday thru Sunday. This is to be consistent with Student Life Gym not being open for access Monday thru Sunday. Oversight of Gym Area for temperature checks, numbers in gym for social distancing, etc. will not be available at this time, 6am thru 2pm each day, therefore, Open Gym access will not be permitted during Fall semester 2020.

[Above list revised 7-11-2020]

Athletic Team Practices

Require Temperature checks prior to practices and games. Practices would be recorded with a daily practice log.

Intercollegiate athletic competition

- 1) NJCAA Directives that will come in JUNE 2020.
- 2) GCAA Directive to follow NJCAA Directives.
- 3) USG/EGSC Directives per Phases of Return to Campus.

The National Junior College Collegiate Athletic Association (NJCAA) on June 19th 2020 gave directive for Fall/Winter sports Return to Play for Junior College Athletics. Colleges were provided Health and Safety Recommendations for Return to Play by the NJCAA in 3 separate handouts, along with start dates and end dates for Fall/Winter play for each individual sport.

The Georgia Collegiate Athletic Association (GCAA) followed the NJCAA directives in their meeting on June 24th, 2020.

The USG Athletic Directors had a Zoom meeting with John Fuchko on June 23rd, 2020 to speak about Best Practices for Athletics in a round table meeting with all USG AD's cross the State of Georgia.

EGSC Athletic Department has developed at a "Return to Play Action Plan" for our EGSC Athletic Staff, Trainers, Coaches, and Players to follow upon our return to Fall Semester.

This plan will address the following:

- 1) Preparation for Return to Campus
- 2) Staff Return
- 3) Student Athlete Return
- 4) Return to Training
- 5) Return to Competition

[This section revised 7-11-2020]

Guidance for the ongoing athletic situation will be guided by institutional decisions reflective of guidance from GDPH, the Governor's COVID-19 Task Force, and the Governor's office. Further considerations will be given from the national athletic associations and athletic conferences. Most of the competition athletic teams require person-to-person interaction that excludes social distancing. Institutions will work with the USG and their institutional affiliate organizations to determine how/if the competition athletic programs will resume in Fall Semester 2020.

*Institutions should develop basic plans for the following:

- Financial implications

Finances would be impacted due to no revenue generated from admission to contest and sales of concessions due to fans not being present at games.

- Initial return of athletes to campus

Staggered Scheduled move in process for athletes moving back on campus and into housing.

□ Practice scenarios

1. Require Temperature checks prior to practices and games. Practices would be recorded with a daily practice log.
2. Practices are closed practices with no outside attendance allowed without permission or checks, with prior approval from Athletic Director.
3. Game days prior to team departure, all players and traveling team personnel will have temperature checks. This will be recorded with a Pass/Fail in order not to violate HIPA laws.
4. Home teams will also certify officials for games prior to contest.
5. Daily temperature check upon arrival to campus for each workday for athletic staff.
6. Temperature checks for on-campus recruits and tryouts.
7. Custodial Staff and Coaches will ensure facility usage has been disinfected prior to and post competition.

□ Competition activities with or without spectators

Directives will be made in June 2020 by NJCAA and GCAA.

EGSC, as a Best Practices Recommendation from the Athletic Director and All Head Coaches at EGSC, for Fall Semester, 2020 will not have spectators for Home Basketball, Baseball, and Softball games, scrimmages, practices, etc.

Each sports team will broadcast live game feeds for Home Games, for spectators, fans and parents to view.

A review of no spectators for Spring 2021 semester will be made in December 2020 to either continue sports with no fans in Spring 2021 or allow fans with social distancing and precautions, signage, and guidance for attendees to sporting events at EGSC.

[Above paragraph revised 7-11-2020]

□ Travel arrangements

Game days prior to team departure, all players and traveling team personnel will have temperature checks. This will be recorded with a Pass/Fail in order not to violate HIPA laws.

Contingency Plan 2 – Fall Semester 2020 classes begin fully online

No Athletics will be played in Fall Semester 2020 if EGSC does not have any face to face classes from the beginning of the Fall Semester 2020.

All above athletic facilities will be closed.

Contingency Plan 3 – Classes and operations must go to an online format for a period of time during the semester

Athletics would be suspended during the period of time that EGSC moves to an on-line format and would return to practice and competition when face to face instruction resumed.

If face to face classes were to end at Thanksgiving Break, November 22nd, 2020, it is possible that Athletes (Basketball Team members) will remain on campus for practices, home games and travel after November 22nd date.

The reason for athletes to remain on campus, would be that Basketball Seasons fall into 2 separate semesters, Winter and Spring, therefore on the November 22nd Thanksgiving Break, the basketball team/teams would be in the middle of their first semester of play, and would need to stay on campus to finish out their first part of their season.

[Above section was revised 7-11-2020]

The USG will work in tandem with the Governor's office, the Governor's COVID-19 Task Force, and the Georgia Department of Public Health (GDPH) to make public health-informed decisions affecting the status of any of our campuses or our system.

Contingency plans 2 and 3 will require similar planning, in that classes and operations must be able to start or transition to an online, remote environment if the COVID-19 situation requires us to do so. Where noted, there will be different submission requirements based on the timing for any move to an online environment. Decisions about moving online will be made at the University System Office in consultation with the Governor's office, the Governor's COVID-19 Task Force, and GDPH. No institution shall make the decision to move online on their own.

Using the Spring Semester 2020 semester as a reflection point with lessons learned, institutions should implement best practices in the online delivery of courses and in the remote delivery of institutional services. These plans should include employees working remotely when possible and employees working on campus. Now is the time to conduct after actions reviews to identify opportunities for improvement in online delivery, as well as inventory the necessary resources that would be required to move to this environment again in the future.

*What preparations will your campus need to make to ensure a smooth transition to an online environment? Will there be additional ramp up time required? If so how much?

EGSC already has an on-line environment for normal classes, and we would implement our Spring Semester 2020 transition that we have already used.

Athletically, our sports teams would need 2 weeks of conditioning, workouts, and practices before return to play.

Guidance for the ongoing athletic situation will be guided by decisions reflective of guidance from GDPH, the Governor's COVID-19 Task Force, and the Governor's office. Further considerations will be given from athletic associations and athletic conferences. Institutions will work with the USG and their affiliate organizations to determine how the competition athletic programs will operate in Fall Semester 2020.

*Identify any additional plans that would need to be in place or considered if the instructional environment moves online.

N/A

ARCHIVED
The COVID-19 Public Health Emergency Declaration ended at midnight on May 11, 2023.
Information for archival use only.

7. Communications

- Norma Kennedy, AVP for Executive Affairs and Interim AVP for Institutional Advancement (Chair)
- Katelyn Moore, Marketing Coordinator
- Harley Smith, Communications Coordinator
- Karen Guthrie, Alumni/Development Coordinator
- Victor Poole, Web Services Specialist

CONTINGENCY PLAN #1 – Fall Semester 2020 Classes Begin with Social Distancing Expectations

“A communications plan must be built for the following working groups:

1. Workplace & Health Safety
2. Academics & Research
3. Public Service, Outreach, Continuing Education & Cooperative Extension
4. Student Life
5. Enrollment Management
6. Athletics

We recommend a communications representative consult with each working group on developing a plan for communicating all of the necessary information from that working group to the appropriate audience. Communication plans should be based on working group plans that have been approved by USG.

*Institutions should submit a communications plan for Contingency Plan #1 with as much information as possible to include the following information:

Example:

Content Topic	Audience	Timeline	Content Owner	Critical points	Method of Communication
Residence Hall Move-In	Residents	3 weeks prior to start of semester	Residence Life Director	<ul style="list-style-type: none"> ● Date/time for move-in ● Social distancing expectations ● Where to arrive 	Primary: email Secondary: social media posts directing students to email”

The following tables summarize EGSC’s communications plans for contingency plan #1 in the above format:

Workplace & Health Safety:

Content Topic	Audience	Timeline	Content Owner	Critical Points	Method of Communication
Workplace and Health Safety	Students, Staff, Faculty, Visitors, Vendors, Community	Before faculty/staff or students return to campus; proposed date – June 1, 2020	Mary Smith, Chief of Staff & Legal Affairs Linda Upchurch, Director of Nursing	1) Ensuring a healthy campus environment while meeting Mission of the college 2) Educate audience on information r/t COVID-19 and campus safety measures (via video announcements, printed signage, D2L and myEGSC acknowledgments, printed letters and email, and webpage announcements) 3) Highlighting personal responsibility as critical to safety of all 4) Formulate a plan for hygiene practices while on campus (face coverings, hand washing, use of hand sanitizers, and cleaning, disinfecting and sanitizing of facilities) 5) Formulate a plan for ensuring appropriate social distancing practices (room spacing, virtual	Email, printed letters, printed signage, D2L announcements, campus TV network, webpage; video; weekly email updates from President Bochner. [Above revised 7-11-2020] (All materials to be recommended and reviewed by Workplace and Health Safety Committee, Human Resources, and EGSC administration prior to implementation)

				<p>meeting, outdoor dining options, etc.)</p> <p>6) Monitoring for changes in safety practices recommended by CDC and GDPH guidelines</p> <p>7) Evaluating effectiveness of safety measures. Make recommendations per outcomes, including need to transition to all online format (as in Spring Semester 2020 plan)</p>	
--	--	--	--	---	--

Academics & Research:

Content Topic	Audience	Timeline	Content Owner	Critical Points	Method of Communication
Academics and Research	Students	We will begin communicating in earnest to students about reopening plans beginning on June 15, 2020. By starting at this time, we will allow students adequate time to consider the limitations of social distancing on their academic experience at EGSC. We plan to communicate with students at least once a week.	Sandra Sharman, VP for Academic & Student Affairs	Changes that will impact the academic and research experience: the understanding that academics will continue to serve the needs of the students, even if we move to online only instructional delivery, and that barring specific directives from the Governor or USG, there should not be much interruption.	<p>Primary: email and text messages</p> <p>Secondary: social media posts directing students to email</p>

Public Service, Outreach, Continuing Education & Cooperative Extension:

Content Topic	Audience	Timeline	Content Owner	Critical Points	Method of Communication
Public Service/ Outreach/Continuing Education/Cooperative Extension	Faculty, Staff, Students, & Community	August 1, 2020	Angie Williams (Chair), Director of Event Planning & Scheduling Jean Schwabe, Community Learning Center Director	Social Distancing Guidelines & Protocols; Maximum Group Sizes; Date, Time, & Location Availability	Website, Social Media, Local & Area Newspapers

Student Life:

Content Topic	Audience	Timeline	Content Owner	Critical Points	Method of Communication
Student Life	Students	We will begin communicating in earnest to students about reopening plans beginning on June 15, 2020. By starting at this time, we will allow students, adequate time to consider the limitations of social distancing on their student life experience at EGSC. We plan to communicate with students at least once a week.	Sandra Sharman, VP for Academic & Student Affairs	Changes that will impact student life: the understanding that student life will continue to serve the needs of the students, even if we move to online only delivery. If students have to vacate the campus, there should not be much interruption, as we are prepared to shift to an online format.	Primary: email and text messages Secondary: social media posts directing students to email

Enrollment Management:

Content Topic	Audience	Timeline	Content Owner	Critical Points	Method of Communication
Access to services and safety precautions EGSC is taking in the various plans as they are implemented	Student and their families	First plan communicated to students and their families by July 15 th .	Jim Beall, Associate VP for Academic Affairs & Enrollment Management	Safety precautions in place and how to contact the various offices for assistance based on the contingency plan in place.	EGSC Website, Email, and Texting.

Athletics:

Content Topic	Audience	Timeline	Content Owner	Critical Points	Method of Communication
Athletics	EGSC Athletes	We will be communicating daily until Fall semester begins in August.	Charles Wimberly, Athletic Director/Head Softball Coach	Safety and return to play for all sports teams for Fall Semester 2020 at EGSC	Emails from Charles Wimberly, EGSC Athletic Director

Fiscal Impact:

Content Topic	Audience	Timeline	Content Owner	Critical Points	Method of Communication
Fiscal Affairs	EGSC Cabinet and Senior Staff	The committee will provide information to Fiscal Affairs at the University System Office as requested.	Cliff Gay, VP for Business Affairs	Fiscal Impact	Communication directly to the President's Office and the USG.

Information Technology:

Content Topic	Audience	Timeline	Content Owner	Critical Points	Method of Communication
Information Technology	Faculty, Staff, & Students	Prior to August 17, 2020	Mike Rountree, VP Information Technology Services	<ol style="list-style-type: none"> 1) Social distancing guidelines and cleanliness of computer classrooms 2) The importance 	Website and email and printed material to place in computer classrooms to inform students of social distancing guidelines and best practices.

				e of utilizing hand sanitizer and/or sanitizing wipes on computer keyboards and mice.	This can be printed on an 8.5x11 sheet of paper to place in the classrooms and on computers that cannot be used.
--	--	--	--	---	--

Student Housing:

Content Topic	Audience	Timeline	Content Owner	Critical Points	Method of Communication
Housing and Residence Life	Students, Staff, Community Members	We will begin communicating in earnest to students about reopening plans beginning on June 15, 2020. By starting at this time, we will allow students to consider the limitations of social distancing on their housing experience and will provide time to cancel their housing before the July 1, 2020 cancellation deadline if they no longer wish to participate. We plan to email communicate with housing students at least once a week.	Angela Storck, Director of Housing	Changes that will impact residential living experience, the understanding that housing will remain open and serving students even if we move to online only instructional delivery, and that barring specific directives from the Governor or USG to move out, housing services should not see much interruption.	Email, Text Messages Social Media posts

External Campuses:

Content Topic	Audience	Timeline	Content Owner	Critical Points	Method of Communication
The external site committee	The audience for this committee are	The timeline for the	The Augusta Director, Nick	The critical points to	The methods of communications will be

<p>was formed to address issues specifically concerning the Augusta, Statesboro and any dual enrollment sites in which faculty will be teaching at the high school. The committee will continue to update key personnel regarding the return to campus plans for AU and GaSouU, as well as any information shared by high school administrators concerning dual enrollment.</p>	<p>EGSC Augusta/Statesboro faculty, staff and students. Specific information will also need to be sent to dual enrollment students at specific off-site high school locations, administrators at the dual enrollment sites and specific dual enrollment instructors from EGSC.</p>	<p>communication and information sharing with our partner institutions is on-going through the summer, leading into the Fall Semester 2020.</p>	<p>Kelch, is the content owner for the information regarding AU. The Statesboro Director, Jessicaca Williamson, is the content owner for information regarding GaSouU. The Dual Enrollment Coordinator, Brandy Murphy, is the content owner for information regarding on-site dual enrollment.</p>	<p>communicate are the Summer and Fall 2020 re-opening approved plans from our partner institutions as well as specific information from our dual enrollment on-site high school partners.</p>	<p>via catmail, text, phone, as well as utilizing our EGSC Augusta/Statesboro specific website via our www.ega.edu domain.</p>
---	--	---	--	--	---

CONTINGENCY PLAN #2 – Fall Semester 2020 Classes Begin Fully Online

“The USG will work in tandem with the Governor’s office, the Governor’s COVID-19 Task Force, and the Georgia Department of Public Health (GDPH) to make public health-informed decisions affecting the status of any of our campuses or our system.

Contingency plans 2 and 3 will require similar planning, in that classes and operations must be able to start or transition to an online, remote environment if the COVID-19 situation requires us to do so. Where noted, there will be different submission requirements based on the timing for any move to an online environment. Decisions about moving online will be made at the University System Office in consultation with the Governor’s office, the Governor’s COVID-19 Task Force, and GDPH. No institution shall make the decision to move online on their own.

Using the Spring Semester 2020 semester as a reflection point with lessons learned, institutions should implement best practices in the online delivery of courses and in the remote delivery of institutional services. These plans should include employees working remotely when possible and employees working on campus. Now is the time to conduct after actions reviews to identify opportunities for improvement in online delivery, as well as inventory the necessary resources that would be required to move to this environment again in the future.

*What preparations will your campus need to make to ensure a smooth transition to an online

environment? Will there be additional ramp up time required? If so how much?

A communications plan must be built for the following working groups in the event an institution must move to a fully online environment either temporarily or for the duration of the semester:

1. Workplace & Health Safety
2. Academics & Research
3. Public Service, Outreach, Continuing Education & Cooperative Extension
4. Student Life
5. Enrollment Management
6. Athletics

We recommend a communications representative consult with each working group on developing a plan for communicating all of the necessary information from that working group to the appropriate audience. Communication plans should be based on working group plans that have been approved by USG.

*Institutions should submit a communications plan for Contingency Plan #2/3 with as much information as possible to include the following information:

Example:

Content Topic	Audience	Timeline	Content Owner	Critical points	Method of Communication
Residence Hall Move-In	Residents	3 weeks prior to start of semester	Residence Life Director	<ul style="list-style-type: none"> • Date/time for move-in • Social distancing expectations • Where to arrive 	Primary: email Secondary: social media posts directing students to email

The following tables summarize EGSC’s communications plans for contingency plan #2 in the above format:

Workplace & Health Safety:

Content Topic	Audience	Timeline	Content Owner	Critical Points	Method of Communication
Workplace and Health Safety	Students, Staff, Faculty, Visitors, Vendors, Community	Before faculty/staff or students return to campus; proposed date – June 1, 2020	Mary Smith, Chief of Staff & Legal Affairs Linda Upchurch, Director of Nursing	1) Ensuring a healthy campus environment while meeting Mission of the college 2) Educate audience on information r/t COVID-19 and campus safety	Email, printed letters, printed signage, D2L announcements, campus TV network, webpage; video (All materials to be recommended and reviewed by

				<p>measures (via video announcements, printed signage, D2L and myEGSC acknowledgments, printed letters and email, and webpage announcements)</p> <p>3) Highlighting personal responsibility as critical to safety of all</p> <p>4) Formulate a plan for hygiene practices while on campus (face coverings, hand washing, use of hand sanitizers, and cleaning and disinfecting and sanitizing of facilities)</p> <p>5) Formulate a plan for ensuring appropriate social distancing practices (room spacing, virtual meeting, outdoor dining options, etc.)</p> <p>6) Monitoring for changes in safety practices recommended by CDC and GDPH guidelines</p> <p>7) Evaluating effectiveness of safety measures. Make recommendations per outcomes, including need to transition to all online format (as</p>	<p>Workplace and Health Safety Committee, Human Resources, and EGSC administration prior to implementation)</p>
--	--	--	--	--	---

				in Spring Semester 2020 plan)	
--	--	--	--	-------------------------------	--

Academics & Research:

Content Topic	Audience	Timeline	Content Owner	Critical Points	Method of Communication
Academics and Research	Students	We will begin communicating in earnest to students about reopening plans beginning on June 1, 2020. By starting at this time, we will allow students, adequate time to consider the limitations of social distancing on their academic experience at EGSC. We plan to communicate with students at least once a week.	Sandra Sharman, VP for Academic & Student Affairs	Changes that will impact the academic and research experience: the understanding that academics will continue to serve the needs of the students, even if we move to online only instructional delivery, and that barring specific directives from the Governor or USG, there should not be much interruption.	Primary: email and text messages Secondary: social media posts directing students to email

Public Service, Outreach, Continuing Education & Cooperative Extension:

Content Topic	Audience	Timeline	Content Owner	Critical Points	Method of Communication
Public Service/ Outreach/Continuing Education/Cooperative Extension	Faculty, Staff, Students, & Community	August 1, 2020	Angie Williams (Chair), Director of Event Planning & Scheduling Jean Schwabe, Community Learning Center Director	Social Distancing Guidelines & Protocols; Maximum Group Sizes; Date, Time, & Location Availability	Website, Social Media, Local & Area Newspapers

Student Life:

Content Topic	Audience	Timeline	Content Owner	Critical Points	Method of Communication
---------------	----------	----------	---------------	-----------------	-------------------------

Student Life	Students	We will begin communicating in earnest to students about reopening plans beginning on June 15, 2020. By starting at this time, we will allow students, adequate time to consider the limitations of social distancing on their student life experience at EGSC. We plan to communicate with students at least once a week.	Sandra Sharman, VP for Academic & Student Affairs	Changes that will impact student life: the understanding that student life will continue to serve the needs of the students, even if we move to online only delivery. If students have to vacate the campus, there should not be much interruption, as we are prepared to shift to an online format.	Primary: email and text messages Secondary: social media posts directing students to email
--------------	----------	--	---	--	---

Enrollment Management:

Content Topic	Audience	Timeline	Content Owner	Critical Points	Method of Communication
Access to services and safety precautions EGSC is taking in the various plans as they are implemented.	Student and their families	First plan communicated to students and their families by July 15 th .	The Director of each department: Admissions Director, Financial Aid Director and Registrar.	Safety precautions in place and how to contact the various offices for assistance based on the contingency plan in place.	EGSC Website, Email, and Texting.

Athletics:

Content Topic	Audience	Timeline	Content Owner	Critical Points	Method of Communication
Athletics	EGSC Athletes	We will be communicating daily until Fall semester begins in August 2020	Charles Wimberly, Athletic Director/Head Softball Coach	Safety and return to play for all sports teams for Fall Semester 2020 at EGSC	Emails from Charles Wimberly, EGSC Athletic Director

Fiscal Impact:

Content Topic	Audience	Timeline	Content Owner	Critical Points	Method of Communication
Fiscal Affairs	EGSC Cabinet and Senior Staff	The committee will provide information to Fiscal Affairs at the University System Office as requested.	Cliff Gay, VP for Business Affairs	Fiscal Impact	Communication directly to the President's Office and the USG.

Information Technology:

Content Topic	Audience	Timeline	Content Owner	Critical Points	Method of Communication
Information Technology	Faculty, Staff, & Students	Prior to August 17, 2020	Mike Rountree, VP Information Technology Services	Informing faculty and students that fall classes will be offered in on online format only.	EGSC Website and email

Student Housing:

Content Topic	Audience	Timeline	Content Owner	Critical Points	Method of Communication
Housing and Residence Life	Students, Staff, Community Members	We will begin communicating in earnest to students about reopening plans beginning on June 15, 2020. By starting at this time, we will allow students to consider the limitations of social distancing on their housing experience and will provide time to cancel their housing before the July 1, 2020 cancellation deadline if they no longer wish to participate. We plan to email	Angela Storck, Director of Housing	Changes that will impact residential living experience, the understanding that housing will remain open and serving students even if we move to online only instructional delivery, and that barring specific directives from the Governor or USG to move out, housing services should not see much interruption.	Email, Text Messages Social Media posts

		communicate with housing students at least once a week.			
--	--	---	--	--	--

External Campuses:

Content Topic	Audience	Timeline	Content Owner	Critical Points	Method of Communication
The external site committee was formed to address issues specifically concerning the Augusta, Statesboro and any dual enrollment sites in which faculty will be teaching at the high school. The committee will continue to update key personnel regarding the return to campus plans for AU and GaSouU, as well as any information shared by high school administrators concerning dual enrollment.	The audience for this committee are EGSC Augusta/ Statesboro faculty, staff and students. Specific information will also need to be sent to dual enrollment students at specific off-site high school locations, administrators at the dual enrollment sites and specific dual enrollment instructors from EGSC.	The timeline for the communication and information sharing with our partner institutions is on-going through Summer Semester 2020, leading into the Fall Semester 2020.	The Augusta Director, Nick Kelch, is the content owner for the information regarding AU. The Statesboro Director, Jessicaca Williamson, is the content owner for information regarding GaSouU. The Dual Enrollment Coordinator is the content owner for information regarding on-site dual enrollment.	The critical points to communicate are the Summer and Fall 2020 re-opening approved plans from our partner institutions as well as specific information from our dual enrollment on-site high school partners.	The methods of communications will be via catmail, text, phone, as well as utilizing our EGSC Augusta/Statesboro specific website via our www.ega.edu domain.

CONTINGENCY PLAN #3 – Classes and Operations Must Go to an Online Format for a Period of Time during the Semester

The following tables summarize EGSC’s communications plans for contingency plan #2 in the above format:

Workplace & Health Safety:

Content Topic	Audience	Timeline	Content Owner	Critical Points	Method of Communication
Workplace and Health Safety	Students, Staff, Faculty, Visitors, Vendors, Community	Before faculty/staff or students return to campus; proposed date – June 1, 2020	Mary Smith, Chief of Staff & Legal Affairs Linda Upchurch, Director of Nursing	<ol style="list-style-type: none"> 1) Ensuring a healthy campus environment while meeting Mission of the college 2) Educate audience on information r/t COVID-19 and campus safety measures (via video announcements, printed signage, D2L and myEGSC acknowledgments, printed letters and email, and webpage announcements) 3) Highlighting personal responsibility as critical to safety of all. 4) Formulate a plan for hygiene practices while on campus (face coverings, hand washing, use of hand sanitizers, and cleaning and disinfecting and sanitizing of facilities) 5) Formulate a plan for ensuring appropriate social distancing practices (room spacing, virtual meeting, outdoor dining options, etc.) 6) Monitoring for changes in safety practices recommended by CDC and GDPH guidelines 7) Evaluating effectiveness of safety measures. Make recommendations per outcomes, including 	<p>Email, printed letters, printed signage, D2L announcements, campus TV network, webpage; video</p> <p>(All materials to be recommended and reviewed by Workplace and Health Safety Committee, Human Resources, and EGSC administration prior to implementation)</p>

				need to transition to all online format (as in Spring Semester 2020 plan)	
--	--	--	--	---	--

Academics & Research:

Content Topic	Audience	Timeline	Content Owner	Critical Points	Method of Communication
Academics and Research	Students	We will begin communicating in earnest to students about reopening plans beginning on June 15, 2020. By starting at this time, we will allow students, adequate time to consider the limitations of social distancing on their academic experience at EGSC. We plan to communicate with students at least once a week.	Sandra Sharman, VP for Academic & Student Affairs	Changes that will impact the academic and research experience: the understanding that academics will continue to serve the needs of the students, even if we move to online only instructional delivery, and that barring specific directives from the Governor or USG, there should not be much interruption.	Primary: email and text messages Secondary: social media posts directing students to email

Public Service, Outreach, Continuing Education & Cooperative Extension:

Content Topic	Audience	Timeline	Content Owner	Critical Points	Method of Communication
Public Service/ Outreach/Continuing Education/Cooperative Extension	Faculty, Staff, Students, & Community	August 1, 2020	Angie Williams (Chair), Director of Event Planning & Scheduling Jean Schwabe, Community Learning Center Director	Social Distancing Guidelines & Protocols; Maximum Group Sizes; Date, Time, & Location Availability	Website, Social Media, Local & Area Newspapers

Student Life:

Content Topic	Audience	Timeline	Content Owner	Critical Points	Method of Communication
Student Life	Students	We will begin communicating in earnest to students	Sandra Sharman, VP for Academic	Changes that will impact student life:	Primary: email and

		about reopening plans beginning on June 15, 2020. By starting at this time, we will allow students, adequate time to consider the limitations of social distancing on their student life experience at EGSC. We plan to communicate with students at least once a week.	& Student Affairs	the understanding that student life will continue to serve the needs of the students, even if we move to online only delivery. If students have to vacate the campus, there should not be much interruption, as we are prepared to shift to an online format.	text messages Secondary: social media posts directing students to email
--	--	---	-------------------	---	--

Enrollment Management:

Content Topic	Audience	Timeline	Content Owner	Critical Points	Method of Communication
Access to services and safety precautions EGSC is taking in the various plans as they are implemented.	Student and their families	First plan communicated to students and their families by July 15 th .	The Director of each department: Admissions Director, Financial Aid Director and Registrar.	Safety precautions in place and how to contact the various offices for assistance based on the contingency plan in place.	EGSC Website, Email, and Texting.

Athletics:

Content Topic	Audience	Timeline	Content Owner	Critical Points	Method of Communication
Athletics	EGSC Athletes	We will be communicating daily until Fall Semester 2020 begins in August 2020.	Charles Wimberly, Athletic Director/Head Softball Coach	Safety and return to play for all sports teams for Fall Semester 2020 at EGSC	Emails from Charles Wimberly, EGSC Athletic Director

Fiscal Impact:

Content Topic	Audience	Timeline	Content Owner	Critical Points	Method of Communication
---------------	----------	----------	---------------	-----------------	-------------------------

Fiscal Affairs	EGSC Cabinet and Senior Staff	The committee will provide information to Fiscal Affairs at the University System Office as requested.	Cliff Gay, VP for Business Affairs	Fiscal Impact	Communication directly to the President's Office and the USG.
----------------	-------------------------------	--	------------------------------------	---------------	---

Information Technology:

Content Topic	Audience	Timeline	Content Owner	Critical Points	Method of Communication
Information Technology	Faculty, Staff, & Students	Prior to the time going online	Mike Rountree, VP Information Technology Services	The date of the transition to online courses. This is a contingency that may or may not happen, however EGSC needs to be prepared.	EGSC Website, email, and signs on campus.

Student Housing:

Content Topic	Audience	Timeline	Content Owner	Critical Points	Method of Communication
Housing and Residence Life	Students, Staff, Community Members	We will begin communicating in earnest to students about reopening plans beginning on June 15, 2020. By starting at this time, we will allow students to consider the limitations of social distancing on their housing experience and will provide time to cancel their housing before the July 1, 2020. cancellation deadline if they	Angela Storck, Director of Housing	Changes that will impact residential living experience, the understanding that housing will remain open and serving students even if we move to online only instructional delivery, and that barring specific directives from the Governor or USG to move out, housing services should not see much interruption.	Email, Text Messages Social Media posts

		no longer wish to participate. We plan to email communicate with housing students at least once a week.			
--	--	---	--	--	--

External Campuses:

Content Topic	Audience	Timeline	Content Owner	Critical Points	Method of Communication
The external site committee was formed to address issues specifically concerning the Augusta, Statesboro and any dual enrollment sites in which faculty will be teaching at the high school. The committee will continue to update key personnel regarding the return to campus plans for AU and GaSouU, as well as any information shared by high school administrators concerning dual enrollment.	The audience for this committee are EGSC Augusta/Statesboro faculty, staff and students. Specific information will also need to be sent to dual enrollment students at specific off-site high school locations, administrators at the dual enrollment sites and specific dual enrollment instructors from EGSC.	The timeline for the communication and information sharing with our partner institutions is on-going through the summer, leading into the Fall Semester 2020.	The Augusta Director, Nick Kelch, is the content owner for the information regarding AU. The Statesboro Director, Jessicaca Williamson, is the content owner for information regarding GaSouU. The Dual Enrollment Coordinator is the content owner for information regarding on-site dual enrollment.	The critical points to communicate are the summer and fall re-opening approved plans from our partner institutions as well as specific information from our dual enrollment on-site high school partners.	The methods of communications will be via catmail, text, phone, as well as utilizing our EGSC Augusta/Statesboro specific website via our www.ega.edu domain.

8. Fiscal Impact

- Cliff Gay, VP for Business Affairs (Chair)
- Sheila Wentz, Director of Financial Accounting
- Meshia Williams, Director of Student Accounts/Payroll

The following is the plan of the Fiscal Impact Sub-committee

CONTINGENCY PLAN #1 (Fall Semester 2020 Classes Begin with Social Distancing Expectations)

Action Steps Necessary to Carry Out this Plan

Compile information from other committees.

Order items requested for purchase.

Reinforce CDC and USG Guidelines via posting of CDC resources.

Reinforce the importance of individual responsibility and citizenship in our EGSC community via public signs.

Staff must take the lead in promoting individual responsibility by means of *leading by example*.

Primary Responsibility and Timeline

- President's Office: Compilation of information from all committees
 - Timeline: by May 21, 2020
- Business Affairs: Order items requested for purchase
 - Timeline: by June 1, 2020
- Marketing: professionally developed/printed signs centered on citizenship and personal responsibility in our EGSC community.
 - Timeline: by August 1, 2020
- Marketing: professionally printed/laminated resources from the CDC.
 - Timeline: by August 1, 2020
- Each Department should begin immediately with *leading by example* to promote individual responsibility.

Education of the EGSC Community about this Component of the Plan

(note: the communications plan above should address the communication techniques which will be used)

Public Signs concerning hand washing, hand sanitizer, physical distancing, wearing protective face coverings, and surface contact.

Emails with education and expectations about hand washing, hand sanitizer, physical distancing, wearing protective face coverings, and contact with surfaces.

Materials and Supplies and Equipment Needed to Carry out the Plan

See **Attachment O***.

Each of the sub-committees developing this plan have submitted lists of materials, supplies and equipment needed. Those lists have been reviewed and compiled by the fiscal impact sub-committee and included in Attachment O.

*For purposes of Attachment O, the items recommended by the other sub-committees (other than IT) have been included within broad categories (not individually itemized).

Fiscal Implications of this Plan

The chart below estimates revenue losses for Fall Semester 2020 based on enrollment declines of five, ten, fifteen, and twenty percent from Fall Semester 2019 revenue.

The “Online 1” and “Online 2” columns represent revenue losses if the College operates at one hundred percent online for all of the fall semester and one-half of the fall semester, respectively. These calculations assume that only the Special Institutional and Technology Fee would be charged during the period that is one hundred percent online.

POTENTIAL FALL 2020 REVENUE LOSSES

	Fall 2019 Revenue	5% Reduction	10% Reduction	15% Reduction	20% Reduction	Online 1	Online 2
General Fund							
Tuition	\$ 3,099,251	\$ 154,963	\$ 309,925	\$ 464,888	\$ 619,850		
Special Institutional Fee	473,459	23,673	47,346	71,019	94,692		
Auxiliary Funds							
Athletic	231,043	11,552	23,104	34,656	46,209	\$ 231,043	\$ 115,522
Health	28,307	1,415	2,831	4,246	5,661	28,307	14,154
Parking	14,181	709	1,418	2,127	2,836	14,181	7,091
Transportation	76,568	3,828	7,657	11,485	15,314	76,568	38,284
Student Activities	30,577	1,529	3,058	4,587	6,115	30,577	15,289
Technology	119,911	5,996	11,991	17,987	23,982		
Totals	\$ 4,073,297	\$ 203,665	\$ 407,330	\$ 610,995	\$ 814,659	\$ 380,676	\$ 190,338

The numbers above reflect estimates based on Fall 2019 revenue only and are not annualized

Online 1 - 100% online and only the Special Institutional and Technology Fee are charged

Online 2 - 100% online for one-half of the semester and only the Special Institutional and Technology Fee are charged

When considering Housing and Dining, which are not included above, the revenue losses may increase significantly depending on the timing of charges and/or the requirements surrounding refunds. The losses can be especially significant if the College assumes full responsibility for the loss of funds related to P3 housing. Housing revenue is approximately \$1,300,000, and dining revenue is approximately \$510,000 per semester. In a worst-case scenario, the College could lose the dining revenue and be required to fund the entire housing revenue loss even though EGSC receives only an estimated twenty to twenty-three percent of total housing revenue for retained services.

If a higher percentage of our students are online during Fall Semester 2020, what is the fiscal impact of a change in the composition of our student body (i.e., higher online)

Under EGSC's typical fee structure, a higher percentage of online students would have a minimal impact; however, mandates from the USG can have a significant effect. The effects of mandates that limit charges or require refunds can be determined by a review of the information above. An extreme example would be the loss of mandatory fees in Column 1 of the chart above and the total amount related to housing and dining, which would be approximately \$2,200,000 in lost revenue and housing liability.

Depending on the circumstances driving a move to a higher percentage of online students, the College could see a reduction in some operating expenditures related to reduced travel and consumption of office supplies. However, the saving would be minimal unless extensive layoffs and position eliminations were to occur.

The college has already been directed to submit a proposed plan assuming a 14% drop in state funding (as compared with FY 2019 original budget). In addition to the specific cuts outlined in our plan, **what additional action should we take now to prepare for the possibility of lost tuition and fee revenue during Fall Semester 2020? What additional action should we be prepared to implement at the time we become certain about the extent of any enrollment drop which may occur?**

In formulating the budget reduction plan in response to the current economic situation, EGSC developed a plan that satisfied the mandated requirements while having the least effect on the mission of the College. EGSC's mission is to provide a point of access to a college education to students that might not otherwise have access. The College fulfills this mission while historically operating on the lowest expenditures per FTE in the USG (USG), so any budget reductions at EGSC will be painful. EGSC's plan includes cuts in travel and operating expenditures, the system guided furloughs, and the elimination of certain vacant positions. In March 2020, when the magnitude of the pandemic became known, EGSC implemented a soft hiring freeze and an enhanced review of open positions. These actions and positions becoming open through promotions and retirements enabled the College to meet the fourteen percent reduction through the elimination of vacant positions.

At present, EGSC should continue to critically review all open positions and continue the strategic management of open positions that began in mid-March 2020. The College should also identify additional positions for potential elimination with the goal of placing affected employees in other positions at the College. The College should use the lessons learned during this time of working remotely to reduce expenditures and improve productivity. We should evaluate the activities that were reduced or eliminated during this period to determine if they should be fully or partially eliminated as we move toward a new normal. Changes could include reducing travel to conferences and meetings and holding more meetings virtually. All operating expenditures should be reviewed, and potential eliminations identified.

EGSC should be prepared to reduce travel, operating, and personnel expenditures as revenue shortfalls dictate. This could include the elimination of all non-essential travel and operating expenditures. The elimination of vacant positions and a reduction in force may also be necessary.

CONTINGENCY PLAN # 2 – Fall Semester 2020 classes begin fully online

“The USG will work in tandem with the Governor's office, the Governor's COVID-19 Task Force, and the Georgia Department of Public Health (GDPH) to make public health-informed decisions affecting the status of any of our campuses or our system.

Contingency plans 2 and 3 will require similar planning, in that classes and operations must be able to start or transition to an online, remote environment if the COVID-19 situation requires us to do so. Where noted, there will be different submission requirements based on the timing for any move to an online environment. Decisions about moving online will be made at the University System Office in consultation with the Governor's office, the Governor's COVID-19 Task Force, and GDPH. No institution shall make the decision to move online on their own.

Using the Spring Semester 2020 semester as a reflection point with lessons learned, institutions

should implement best practices in the online delivery of courses and in the remote delivery of institutional services. These plans should include employees working remotely when possible and employees working on campus. Now is the time to conduct after actions reviews to identify opportunities for improvement in online delivery, as well as inventory the necessary resources that would be required to move to this environment again in the future.

What preparations will your campus need to make to ensure a smooth transition to an online environment? Will there be additional ramp up time required? If so how much?

Purchase of laptops for staff to use for working remotely.

At the end of useful life, transition desktop computers to laptops with docking stations.

Purchase cameras/microphones for office desktops to facilitate remote meeting formats.

To ensure student information is protected, best practices for remote delivery of institutional services should include ensuring staff have and are utilizing the appropriate technology for remote use (i.e., updated laptops, updated versions of software, and VPN access).

To improve employee/department efficiency and to reduce student/family frustrations, our institution should rethink how we manage our phone system to serve our students.

- An expanded phone tree would allow the institution to spread the call load over multiple staff.
 - For F/Aid, press #
 - Students with the last name that begins A – E, press #
 - Students with the last name that begins F – L, press #
- A voicemail to text transcription function would allow staff to prioritize calls from students and respond sooner.

This scenario could cause significant changes, especially to Auxiliary Enterprises, if fees were reduced or eliminated. While EGSC has not moved aggressively to eliminate positions, continuing fully online into Fall 2020 would require an evaluation of many positions, including areas such as:

- Auxiliary – Athletics, Dining, Housing
- Plant Operations,
- Student Life
- Library
- Tutoring – Use of online services
- Faculty – Larger class sizes in a virtual environment

The College would also need to evaluate expenditures on travel, operating, facilities, and contracted services such and Health Services and Grounds.

CONTINGENCY PLAN #3 – Classes and operations must go to an online format for a period of time during the semester

This plan could mirror Plan 1 or 2, depending on the anticipated duration.

ARCHIVED
The COVID-19 Public Health Emergency Declaration ended at midnight on May 11, 2023.
Information for archival use only.

9. IT

- Mike Rountree, VP for IT (Chair)
- Terri Brown, Director of eLearning
- Ty Fagler, Manager of Infrastructure Services
- Steven Clark, Manager of Enterprise Services
- Joe Canady, Network and Technology Support Specialist
- Ashley Woods, Chief Security Officer
- Teresa Oglesby, Manager of Support Services
- Greg Avra, Technology and Network Specialist
- Treva Johnson, IT Applications Analyst

CONTINGENCY PLAN #1 (Fall Semester 2020 Classes Begin with Social Distancing Expectations)

Action Steps to Carry Out this Plan

1. Classrooms will need to be equipped with webcams with built-in microphones (if available) and webcam stands to **facilitate online / synchronous instruction**.
2. Protective keyboard and mouse covers (if available) should be utilized on the keyboards and mice of student accessible computers.
3. Computer classrooms will need to be configured to adhere to social distancing guidelines by removing keyboards and mice from the computer desks in the classrooms that are located less than six feet from another computer desk. Signage will be placed on the tops of computer desks that cannot be utilized due to social distancing guidelines. Additionally, the chairs will be removed from the respective computer desks.
4. A hand sanitizer gel dispenser (if available) should be located at the door of each classroom.
5. A sanitizing wipe dispenser (if available) should be provided in each classroom, especially classrooms with computers and other student/publicly accessible areas that have computers.
6. Signage should be placed in all classrooms with information about social distancing and sneeze/cough etiquette.
7. Webcams with built-in microphones (if available) will need to be provided to faculty who wish to conduct online sessions in their offices and who do not have a laptop or iPad with a built-in web camera.

Responsibility and Timeline for Action Steps

For action step 1, the Information Technology unit has the primary responsibility. Depending on the availability of web cameras, the timeline for this action step to be taken and completed is prior to August 17, 2020.

For action step 2, the Information Technology unit and units (i.e. Library, ACE, Student Testing) where student accessible computers are located / utilized will have primary responsibility. Depending on the availability of the protective keyboard and mouse covers, the timeline for this action step to be taken and completed is prior to August 17, 2020.

For action step 3, the Information Technology and Plant Operations units will have primary responsibility. The timeline for this action step to be taken and completed is prior to August 17, 2020.

For action step 4, the Plant Operations unit will likely have primary responsibility. Depending on the availability of the hand sanitizer gel dispensers, the timeline for this action step to be taken and completed is prior to August 17, 2020.

For action step 5, the Plant Operations unit will likely have primary responsibility. Depending on the availability of the sanitizing wipe dispensers, the timeline for this action step to be taken and completed is prior to August 17, 2020.

For action step 6, the Marking & Communications, Information Technology, and Plant Operations units will have primary responsibility. The timeline for this action step to be taken and completed is prior to August 17, 2020.

For action step 7, the Information Technology unit has the primary responsibility. Depending on the availability of web cameras, the timeline for this action step to be taken and completed is prior to August 17, 2020.

Educating the EGSC Community about the IT Component of this Plan

The Information Technology Workgroup's topics listed below should be covered in a communication plan to educate the EGSC community about workplace health and safety as part of the college's return to campus plan.

1. The importance of utilizing hand sanitizer and/or sanitizing wipes on computer keyboards and mice.
2. The need to utilize covers on computer keyboards and mice to help maintain student health and safety.
3. The need to configure computer classrooms in order to adhere to necessary social distancing guidelines.

Materials and Supplies and Equipment Needed

- Webcams with integrated microphone
- Webcam goose neck stand for each classroom
- Mouse covers/disposable
- Keyboard covers/disposable bags
- Sanitizing wipes dispenser stands

- Sanitizing gel dispenser stands
- Sanitizing wipes and gel refills for stands
- UV Cordless Sterilizer

IT Considerations Under Each of the Scenarios Posed by the USG

During Spring Semester 2020, faculty throughout the USG and EGSC were notified that classes would resume online only after spring break. This gave faculty two weeks, at most, to prepare for teaching online. All EGSC faculty were able to successfully transition to online classes with training materials, one-on-one help, and the guidance of USG resources. Faculty are being instructed by the Vice President for Academic and Student Affairs to start Fall Semester 2020 with “shift-to-online” plans and materials already prepared and loaded into Georgia View D2L Brightspace system in case a shift to online occurs at any point during the semester. Therefore, there should be no need for additional ramp up time.

Academic Year 2020-2021 Start – Fall Semester classes begin with limited social distancing expectations

EGSC plans to begin Fall Semester 2020 semester with face-to-face classes with limited social distancing practicing in place. The EGSC Information Technology unit will address the limited social distancing requirements in its computer classrooms by removing chairs from the computer desks as needed in order to maintain the recommended distance between students. There will be signage placed in computer classrooms to notify students of the requirements of social distancing and the reason chairs have been removed from some of the computer desks.

The Information Technology unit will utilize protective bags and/or covers (if available) for the keyboards and mice of the available computers in the computer classrooms. Signage will be provided instructing students about cleaning and disinfecting surfaces they will use in the classroom. Cleaning wipes and hand sanitizer dispensers (if available) will be provided at the doors to computer classrooms for faculty and students to use to sanitize their hands and the surfaces of spaces that will be used in the classrooms. Depending on the level of social distancing required, plexiglass shields may be needed in classrooms.

Classrooms will need to be equipped with webcams with built-in microphones (if available), webcam stands, and Zoom Pro software in order to facilitate online components of classes. Webcams with built-in microphones (if available) and Zoom Pro software will need to be provided to faculty who wish to conduct online sessions in their offices.

Contingency Plan 1 - Fall Semester 2020 classes begin with social distancing expectations

To begin classes in Fall Semester 2020 with social distancing in place, the EGSC Information Technology unit will address the social distancing in the computer classroom by removing chairs from the computers desks as needed in order to maintain the required six feet distance between students. There will be signage placed in the classrooms to notify students of the requirements of social distancing and the reason the chairs have been removed from some of the computer desks.

The Information Technology unit will utilize protective bags and/or covers (if available) for the keyboards and mice of the available computers in the computer classrooms. Signage will be provided instructing students about cleaning and disinfecting surfaces they will use in the classroom. Cleaning wipes and hand sanitizer dispensers (if available) will be provided at the doors to computer classrooms for faculty and students to use to sanitize their hands and the surfaces of spaces that will be used in the classrooms. Depending on the level of social distancing required, plexiglass shields may be needed in classrooms.

Classrooms will need to be equipped with webcams with built-in microphones (if available), webcam stands, and Zoom Pro software in order to facilitate online components of classes. Webcams with built-in microphones (if available) and Zoom Pro software will need to be provided to faculty who wish to conduct online sessions in their offices.

Contingency Plan 2 – Fall Semester 2020 classes begin fully online

EGSC will be prepared to go fully online at the beginning of Fall Semester 2020 should the University System Office in consultation with the Governor’s office, the Governor’s COVID-19 Task Force, and GDPH recommend this course of action.

Many of EGSC classes include online components and transitioning to online should be completed relatively easily given the college’s experience of having to transition its Spring Semester 2020 classes totally online. Summer semester 2020 classes were also totally online and can be updated for Fall Semester. Faculty are also being instructed by the Vice President for Academic and Student Affairs to begin Fall Semester 2020 with shift-to-online plans and materials already prepared and loaded into the Georgia View D2L Brightspace system in case a shift to totally online classes occurs at any point during the semester. These instructions would enable classes for Fall Semester 2020 to begin totally online at the beginning of the semester.

If deemed necessary, faculty and staff would be able to return to “teleworking” schedules that were utilized during spring and summer semesters in order to comply with any shelter-in-place or other similar requirements that may be activated. The necessary information technology components utilized to facilitate teleworking schedules during spring and summer semesters would be implemented again.

In this contingency plan, the various sanitizing supplies that have been identified will not be needed, and there will not be a need to configure computer classrooms to accommodate social distancing requirements. Additionally, the web cameras and web camera stands for the classrooms will not be needed, and there will not be a need for the signage in classrooms that has been identified.

Contingency Plan 3 – Classes and operations must go to an online format for a period of time during the semester

EGSC will be prepared to go fully online at any time during the semester should the mandate be passed down from the University System Office. Faculty are being instructed by the Vice President for Academic and Student Affairs to begin the Fall Semester with “shift-to-online” plans and materials already prepared and loaded into the Georgia View D2L Brightspace system in the event a shift to totally online occurs at any point during the Fall Semester 2020. Therefore, classes should be ready in

the Georgia View D2L Brightspace system and materials will be made available to students from the beginning of the semester. These steps will ensure that student instruction will continue under this mandate.

If deemed necessary, faculty and staff would be able to return to “teleworking” schedules that were utilized during Spring and Summer Semesters 2020 in order to comply with any shelter-in-place or other similar requirements that may be activated. The necessary information technology components utilized to facilitate teleworking schedules during Spring and Summer Semesters 2020 would be implemented again.

In this contingency plan, depending on the time frame that classes go to a totally online format, the quantity of the various cleaning, disinfecting and sanitizing supplies that have been identified will need to be adjusted accordingly. It will still likely be necessary to configure computer classrooms to accommodate social distancing requirements. Additionally, web cameras with built-in microphones and web camera stands for all classrooms will still be needed as well as for faculty who wish to conduct online sessions in their offices. The identified signage for classrooms will also still be needed.

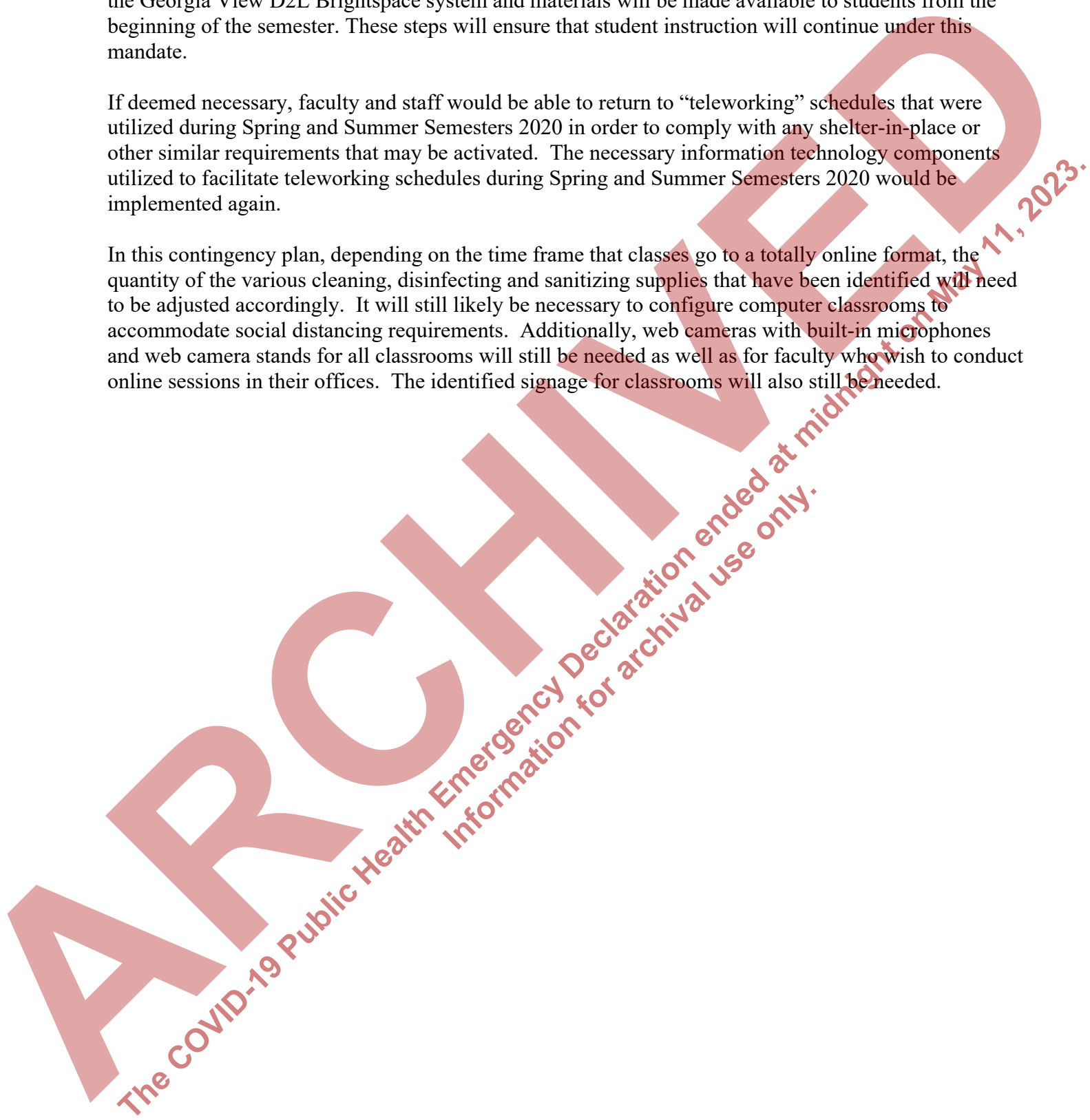

10. External campuses (Statesboro and Augusta)

- Nick Kelch, AVP for External Campuses/Director of EGSC Augusta (Chair)
- Jessica Williamson, Director of EGSC Statesboro
- Mary Smith, Chief of Staff/Legal Counsel
- Dr. Carlos Cunha, Dean, School of Humanities and Social Sciences
- David Chevalier, Chair, Department of Biology
- Brandy Murphy, Coordinator of Dual Enrollment

The following is the plan of the External Campuses Sub-committee:

	Scenario #1 1. Academic Year 2020-2021 Start – Fall classes begin with limited social distancing expectations	Contingency Plan 1 Fall classes begin with social distancing expectations	Contingency Plan 2 Fall classes begin fully online	Contingency Plan 3 Classes and operations must go to an online format for a period of time during the semester
What are the guiding principles which your sub-committee used to formulate this plan for workplace health and safety?	<ul style="list-style-type: none"> • Continual change during the period of time covered by this initial return to campus plan is a certainty. We must adapt continually. • It is important to coordinate our plan with the plans of our sister institutions (GaSouU and AU) since EGSC operates programs in Statesboro and Augusta in partnership with those institutions. It is also important to coordinate our plans with the dual enrollment off-campus instructional sites. 	No change	No change	No change

	<ul style="list-style-type: none"> • Communication on a regular basis with all key constituencies (students/faculty and staff/community) is a priority • It is important to continually and regularly assess this plan to determine if this plan is working well; and it is important to modify the plan as needed in response to these evaluations 			
<p>What are the specific action steps necessary to carry out this plan?</p>	<ul style="list-style-type: none"> • The AVP for External Campuses will continue to stay in contact with AU in order to communicate and incorporate AU's plan of action. • The Director of EGSC-Statesboro will continue to stay in contact with GaSouU in order to communicate and incorporate GS's plan of action. • The Dual Enrollment Coordinator will continue to stay in contact with each 	<p>No Change</p>	<p>No Change</p>	<ul style="list-style-type: none"> • In addition to the action steps taken in scenario #1; • Both the AVP for External Campuses and the Director of EGSC-Statesboro will contact IT to ensure an appropriate number of laptops are available on campus and develop plans of action with the Director of Financial Aid and Director of Admissions.

	high school instructional site in order to communicate and incorporate each plan of action.			<ul style="list-style-type: none"> Both the AVP for External Campuses and the Director of EGSC-Statesboro will contact appropriate personnel to inquire about EGSC cell phones for main telephone lines for campuses.
What topics relating to your sub-committee's work must be covered in a plan to educate the EGSC community about this component (workplace health and safety) of the return to campus plan? (note: the communications plan below should address the communication techniques which will be used)	The critical topic(s) to communicate to the EGSC community are the re-opening plans for our partner institutions (AU and GS), as well as CDC guidelines and specific re-opening plans for our dual enrollment off-campus instructional sites. Email, text messages and phone calls will be the primary techniques used to communicate with the EGSC community, as well as utilizing our specific off-site campus webpages via our www.ega.edu domain.	No Change	No Change	No Change
What specific materials and supplies and	Itemized lists have been sent in for approval on	No Change	No Change	The AVP for external campuses and Statesboro

<p>equipment will be needed to carry out your committee's part of this plan during Fall Semester 2020?</p>	<p>5/21/2020. Items include signage, wipes, dispensers, etc. Please refer to the health and safety committee plan for details.</p>			<p>Director will work with Information Technology to ensure appropriate staff have the off-site locations have laptops to continue work remotely.</p>
---	--	--	--	---

*What preparations will your campus need to make to ensure a smooth transition to an online environment? Will there be additional ramp up time?required? If so how much?

The AVP for External Campuses and EGSC-Statesboro Director will ensure an adequate number of laptops are located on campus for staff who will need to utilize an EGSC laptop for remote work.

We will collaborate with Enrollment Management to have a plan in place for recruitment and student financial aid services during the online environment, specific to the needs of the off-site locations.

We will work with the dual enrollment coordinator to ensure that book delivery and drop-offs are coordinated and communicated to appropriate personnel.

We will initiate conversations regarding EGSC cell phones assigned for campus main phone lines with the Information Technology Department.

No additional ramp up time will be required to move to remote delivery of institutional services for the Augusta or Statesboro campus.

*Please refer to the Academic and Research Committee plan for information regarding faculty and online delivery of courses for the off-campus instructional sites.

*The plan acknowledges that students and employees at EGSC's instructional sites at EGSC Augusta (located on the AU Summerville Campus) and EGSC Statesboro (students and employees use GaSouU classrooms and facilities) are subject to this plan as well as AU's reopening plan or GaSouU's reopening plan, respectively. When AU's reopening plan and GaSouU's reopening plan are available, each will be incorporated into the EGSC reopening plan. EGSC's communication plan to the students and employees at these instructional sites will include standalone communications that summarize, incorporate or refer to AU or GSU's reopening plan guidelines.

*This plan acknowledges that employees at EGSC's dual enrollment instructional sites are subject to this plan as well as the plans or guidelines for each of the aforementioned instructional sites. A list of high schools are provided below. When the reopening guidelines for each of these sites become available, each will be incorporated into the EGSC reopening plan. EGSC's communication plan to the students and employees at these instructional sites will include standalone communications that summarize, incorporate or refer to their respective high schools' reopening plan guidelines.

Current Dual Enrollment off-campus instructional sites for Fall Semester 2020 are as follows:

Brentwood High School
Evans High School
Hephzibah High School
Harlem High School
Jefferson County High School
Screven County High School
[List revised 7-11-2020]

ARCHIVED
The COVID-19 Public Health Emergency Declaration ended at midnight on May 11, 2023.
Information for archival use only.

Attachment A

ACHA Guidelines

Considerations for Reopening Institutions of Higher Education in the COVID-19 Era

Introduction

This sequel to the American College Health Association's *Guidelines: Preparing for COVID-19* addresses administrative, medical, mental health, health promotion/well-being, and campus-wide considerations in reopening college/university campuses as the COVID-19 pandemic abates. Many public health experts and organizations have already developed models and projections using surveillance data, case counts, and infrastructure capability to identify when businesses, schools, campuses, and the country can safely reopen.

Individual states in conjunction with public health entities and institutions of higher education (IHE) presidents/chancellors will ultimately determine when to reopen campuses. These ACHA guidelines provide considerations to minimize the risk of COVID-19 infection and a recurrent surge of infections as social distancing measures are relaxed on our campuses and in our communities and as we plan for the physical return of large numbers of students, faculty, and staff.

The risk of subsequent waves of infection remains until we achieve sufficient herd immunity through vaccination or actual infection and recovery. Clinical trials and vaccine development efforts have begun in earnest.

However, to date, no vaccine or prophylactic pharmacologic exist. Our only tools are prevention through non-pharmacologic interventions, sound public health practices, and supportive therapy. Therefore, the campus must be prepared on multiple fronts. Campus leadership should retain or develop an incident command structure, an effective surveillance system, and partnerships with local public health and health care organizations. The student health service (SHS) remains central to this public health effort and must have sufficient resources to address both COVID-19 surveillance and containment along with all other routine health and well-being needs of students. Even prior to the pandemic, the demand for mental health services often outstripped campus resources. Innovative approaches to stretch those resources further will be needed as this pandemic continues to take its toll on the mental health of students, faculty, and staff. The health promotion role in reinforcing public health's infection prevention practices and influencing positive health behaviors are integral to the totality of student wellness and that of the campus in this phase of the pandemic.

Working in concert, these broad areas provide campus leadership with surveillance capability, a sound infection prevention and control strategy, and a means to quickly identify, isolate, treat, and refer individuals to mitigate a second wave of infection.

Key Concepts

- COVID-19, a novel coronavirus infection emerging in 2019, has led to an unprecedented infectious disease risk for all persons. The duration of this pandemic remains unclear, and the situation continues to evolve. COVID-19 will peak in different states at different times and will impact each IHE differently. Public health guidance, scientific knowledge, and clinical best practices will change, so these guidelines may require updates or risk quickly becoming obsolete. The single constant for each IHE is that the road to recovery will be long. We can anticipate restrictions and limitations in activities will be in place for the next 12–18 months, if not longer

- Resumption of activities will be gradual and phased based on local public health conditions as well as institutional capacity. Return to an active on-campus environment will depend upon widespread testing,

Contact tracing, and isolation/quarantine of ill and exposed individuals both on campus and in the community. Planners should prepare for the likelihood of a local rebound of infections that may result in a return to more restrictive mitigation measures and physical distancing for periods of time.

- The high touch, highly interactive, mobile, densely populated living and learning environment typical of most campuses is the exemplar of a congregate setting with multiple risk factors for ready transmission of COVID-19.
- Protecting our most vulnerable populations (medically susceptible, undocumented, students of color, uninsured or underinsured, non-traditional, older, DACA, and homeless students, faculty, and staff members) is a moral and ethical obligation. Some vulnerable individuals may need to observe ongoing physical distancing for a more prolonged period of time.
- Meticulous adherence to public health practices including hand hygiene, physical distancing, proper cough/sneeze etiquette, frequent disinfection of common and high traffic areas, symptom assessment, temperature checks, and face covering in public is the campus' new normal. This should be widely communicated to students, employees, and all campus visitors.
- The White House's "Opening Up America Again" plan identifies a phased approach to easing restrictions which will be dictated in large part by COVID-19 activity state to state. Campuses considering a similar approach should include community and campus triggers. Suggested criteria are located in Appendix A.
- Faculty, staff, and student immunity to COVID-19 will be essential for long term campus planning, management, and recovery.

Public Health Considerations

The overarching question is how to repopulate campuses in the safest way possible. The college/university must address the public health issues caused by the virus in a manner that permits easing physical distancing practices and the resumption of many of the activities and educational experiences of a vibrant campus.

Until a vaccine for COVID-19 is available and widely used or until an effective prophylactic treatment is discovered, physical distancing, viral testing, isolation, quarantine, and contact tracing are our best strategies to control the spread of this virus. Decisions to ease COVID-

19 distancing restrictions must be based on the best available scientific data and the rapid availability of testing. Campus experts, in collaboration with public health officials, are best positioned to inform and advise campus leadership on when to resume operations.

The campus must deploy primary public health controls to slow the transmission and reduce the mortality associated with COVID-19. These control measures include availability of appropriate personal protective equipment (PPE); environmental measures such as enhanced cleaning and disinfection, physical distancing, testing, and contact tracing; and the readiness of the campus and local health care systems and the campus infrastructure. Controls must be designed, implemented, and

monitored to prevent and/or mitigate negative strategic, operational, financial, reputational, health, and safety impacts on the institution.

Containment and Surveillance Capabilities

Containment measures are multi-pronged and include surveillance, rapid identification of infection with immediate isolation, contact tracing, and quarantine. Currently available antibody (serologic) tests lack adequate evaluation of efficacy and reliability and are inadequate to determine whether a positive test conveys immunity. Antibody tests are currently best positioned to be used as part of research or public health surveillance efforts to determine estimates of population exposure. As antibody testing evolves, it may eventually play a role in diagnosis and determination of individuals at risk for infection.

Surveillance is the cornerstone of effective public health. Surveillance systems should detect the emergence and spread of infection within the general community and within specific campus populations. As the primary health resource for campus, SHS should take the lead in identifying at-risk groups such as SHS staff, first responders, on-campus residential students, athletes, Greek life members, medically vulnerable students, or other known student populations with frequent close contact. At some campuses, SHS may be asked to coordinate surveillance systems for non-student members of the campus community as well.

The SHS in collaboration with a partner health care organization and/or local public health department should develop the following capabilities for campus:

- Access to immediate viral testing for all students, faculty, or staff with symptoms.
- Contact tracing, identification, and quarantine of all persons exposed to COVID-19.
- Case management of all persons with COVID-19 symptoms and/or diagnosis and all persons under quarantine after exposure, including placement in isolation/quarantine housing, psychological support, support for basic needs, and ongoing monitoring while isolated.
- Syndromic surveillance utilizing EHR data, ongoing tracking of influenza-like illness (ILI) and COVID-19 symptoms, and, when possible, viral surveillance of asymptomatic students.
- Reliable, accurate antibody (serologic) testing, as appropriate based on emerging information.
- Future large-scale delivery of COVID-19 vaccines, when developed.

The Workforce

The college/university must build the necessary staffing capacity to resume not only their primary responsibilities but also the competency to understand their role in reducing transmission of COVID-19. Faculty and staff must be protected, trained, and adequately prepared.

Workforce protection and safety are critical to reopening, and measures must be taken to ensure the faculty, staff, students, and campus community have appropriate protective controls, plans, supplies, and guidance to safely return to work. Opportunities for open dialogue must exist to reassure faculty and staff that their health and safety are paramount.

To ensure faculty, staff, and students have access to the same basic information, formal education/training regarding COVID-19 should be offered. The campus COVID-19 planning and response committee in collaboration with IHE senior leaders would recommend the format and

frequency of training and develop a system to monitor compliance (if the training is deemed mandatory). The training should offer the following minimum content:

- A general overview of COVID-19 including infection prevention and control measures (hand hygiene, respiratory etiquette, physical distancing, cleaning, and disinfection), signs and symptoms, testing, transmission, and credible resources.
- Campus-specific policies and practices regarding infection prevention and control, campus health and safety resources, use of PPE including protective face coverings/face coverings, and actions if sick.

Employee Considerations

Employees should be given the following instructions for protecting their health and reducing transmission:

- Avoid office gatherings, break rooms, and unnecessary visitors in the workplace.
- Monitor for presence of COVID-19 symptoms (see <https://www.cdc.gov/coronavirus/2019-ncov/symptoms-testing/symptoms.html>).
- Stay home (or leave the workplace) and notify the supervisor if symptoms develop.
- Wear protective face coverings or face coverings in all public spaces and spaces used by multiple people.
- Know where to find local information on COVID-19 and local trends of COVID-19 cases.

Supervisor Considerations

Supervisors should be given the following instructions for protecting the health of their employees and reducing transmission:

- Conduct meetings electronically, even when working on campus. If meetings cannot be conducted virtually, keep participation to fewer than 10 participants and enforce appropriate physical distancing and wearing of protective face coverings or face coverings.
- Encourage those with increased risk of severe illness or over the age of 65 to continue working remotely and avoid gatherings of greater than 10 or other situations of potential exposures, including travel.
- Consider phased return of employees to no more than 30% of the workforce at a time, staggering every 2–4 weeks for full return. Depending on the size and needs of the workforce, the percentage may vary. Numbers of employees are also dependent upon availability of PPE, support for increased environmental cleaning and disinfection, and availability of employee health care.
- Stagger shifts to reduce the number of people in the workplace at the same time.
- Gauge employee willingness to volunteer to be the first to return and prioritize those with the greatest ability/desire to return, while paying attention to individual risk factors.
- Allow those who can work effectively from home to be the last to return and/or delay their return to the campus.
- Encourage single occupancy in work rooms.

- Procure sufficient disinfectant products and cleaning supplies so employees can frequently clean their own workspaces.
- Ensure that housekeeping is provided PPE and guidelines on appropriate techniques (as per CDC guidelines) for cleaning and disinfecting common, non-clinical spaces.
- Post and promote prevention strategies:
 - Wash hands frequently.
 - Maintain physical distance: stay 6 feet apart at all times.
 - Know the signs and symptoms of COVID-19 and what to do if symptomatic:
 - Stay home when you are sick (or leave work immediately) and notify your supervisor.
 - Call your health care provider's office in advance of a visit.
 - Limit movement in the community and wear a face covering in public.
 - Call your health care provider for instructions regarding return to work.

Facility Considerations

The following recommendations should be provided to those on campus responsible for maintaining facilities or ordering materials and supplies:

- Maintain at least 6 feet between workstations/workers. Place plexiglass or other barriers in workspaces where people must face each other or unable to be 6 feet apart.
- Consider installing plexiglass barriers at high-visited areas such as reception desks and check-in points.
- Place appropriate signage at entrances indicating how to proceed.
- Remove chairs and desks to ensure proper physical distancing in conference and waiting rooms. Identify allowable occupancy in order to control workflow and/or establish maximum attendance.
- Make face coverings available throughout campus (e.g., at the bookstore, pharmacy, etc.).
- Post maximum occupancy in common break areas and configure to accommodate appropriate physical distancing.
- Provide sanitizing supplies for individuals to clean their areas before and after use.
- Eliminate reusable kitchen items (flatware, dishes, and cups) and cleaning tools (sponges, brushes, towels) and replace with single use options.
- Replace shared appliances with single use or no-touch options (coffee makers, ice/water dispensers).
- Remove high-touch items such as magazines, common pens, etc.
- Provide hand sanitizer at all entrances and high-traffic areas.
- Identify frequently touched areas (doors, cabinets, etc.) and investigate options to implement no/reduced touch options such as door removal, card access, foot-operated door pulls/pedals, or sensor-triggered doors.
- Monitor and secure inventories of PPE, hand sanitizer, wipes, cleaning products, and hand soap.

Instruction and Learning Environments

Since the release on March 3, 2020, of the *ACHA Guidelines: Preparing for COVID-19*, almost all institutions of higher education transitioned to an online/virtual mode of instruction. While these efforts have allowed the teaching and learning missions of universities to continue, there are limitations to remote instruction. Planning should include strategies guided by public health considerations to resume in-person instruction.

General considerations should include:

- Prioritization of in-person instruction for courses with academic outcomes that cannot be measured or achieved virtually, such as performance, laboratory, and clinical experiences.
- Implementation of a hybrid mode of instruction for the foreseeable future. Remote options should be planned for and available in the event that a rebound in local infections necessitates continued physical distancing and to support vulnerable students and staff, students in quarantine or isolation, and students and staff who cannot physically return to campus.
- Limitation of the number of attendees for in-person courses/sections. In most cases, all in-person courses/sections should be limited to fewer than 30 participants and also utilize other physical distancing measures. Consider creating multiple sections/shifts to reduce numbers.
- Implementation of close monitoring and tracking of in-person attendance and seating arrangements to facilitate contact tracing in the event of an exposure
- Development of a physical distancing plan for each course that includes:
 - Number of students and faculty present in each session.
 - Length of session.
 - Nature of activities.
 - Mechanisms to conduct student and faculty symptom checks.
 - Public health practices: face coverings, 6 feet of physical distancing, cough/sneeze etiquette, hand hygiene.
 - Provisions for hand sanitizer and enhanced cleaning.
 - Instructions to participants on the course- specific physical distancing protocol.
 - Availability of remote options.
- Development of specialized plans for students who are at increased risk due to the occupational nature of their studies. Examples include health professional students and students engaged in out-of-classroom or community-based instruction. Ensure students are provided with adequate PPE, supervision, and other protections based on their risk.
- Expansion of simulation experiences to create clinical scenarios for health professional students to practice technical, diagnostic, and exam skills.
- Development of specialized plans for courses and instruction that do not permit physical distancing and/or involve activities of higher risk. Examples include dance, theater, and performing arts.

- Development of attendance and excuse policies that acknowledge and support students who become ill without creating barriers and without requiring unnecessary visits to health facilities for documentation of illness.
- Encourage faculty-student communication regarding health status and any changes in their ability to complete coursework and academic responsibilities.
- Identification of resources for students with learning disabilities or difficulties with remote learning platforms.

Student Health Services

Student health services (SHS) preparation should focus on maximizing its assets and capabilities before a large-scale physical return to campus. Strengthening campus and community partnerships; planning for containment; shoring up the supply chain; anticipating personal

protective equipment (PPE) and medical supplies for screening, mass vaccination, and treatment; reconfiguring the facility; updating policies and procedures; training staff; and addressing the budget are critical at this time.

The campus will continue to look to the SHS for medical and public health expertise, and SHS leadership should be poised to deliver current, sound, evidence-informed recommendations.

Patient Care Considerations

SHS preparation for patient care was well-delineated in the *ACHA Guidelines: Preparing for COVID 19* (dated March 3, 2020). Since that document was released, most students have physically left campus. Many SHS have implemented telemedicine to provide access to care, protect staff, and conserve scarce PPE. Asymptomatic transmission of COVID-19 has been documented and presenting symptoms and the course of the disease have become clearer, though much remains unknown.

In concert with the recommendations outlined in the *ACHA Guidelines: Preparing for COVID-19*, the SHS should:

- Advise patients to make online appointments or call before coming to the SHS for nursing or provider visits.
- Develop processes to limit student contact with SHS computers/keypads. Have students complete and submit forms (health history, immunizations, consents, etc.) in the patient portal or utilize EMR templates.
- Continue to utilize telemedicine visits and provide students with options for telemedicine or telephone consults when appropriate. In particular, students with conditions placing them at higher risk for complications from COVID-19 should be encouraged to seek care via telemedicine.
- Develop an online or telephone process for patient check-in, if possible.
- Update triage protocols incorporating telehealth options.
- Update screening forms to include chills, repeated shaking with chills, muscle pain, headache, sore throat, anosmia, dysgeusia, and any other COVID-19 symptoms.
- Screen all patients and staff for respiratory symptoms and check temperature (ideally with infrared or laser devices) before entering the clinic.

- Develop protocols for managing patients with acute respiratory symptoms that include protective face covering for the patient, quickly rooming the patient, limiting and tracking the number of staff who enter the room, limiting the movement of the patient throughout the SHS, and cleaning of spaces where the patient was present.
- Avoid use of nebulizers and peak flow measurements which can generate additional aerosols.
- Require all patients to wear face protective face coverings (or cloth face coverings if adequate face protective face coverings are not available).
- Prohibit visitors, children, or accompanying guests who are not receiving care or services from entering the facility.
- Develop relationship and agreement with local emergency departments (ED) to accept ill patients requiring a higher level of care.
- Develop a plan for students with respiratory symptoms who need transportation to SHS, housing, or local hospitals.
- Develop a communications plan involving the campus communications office, outlining key messages such as how to access care and schedule appointments and which visits should be in person versus virtual. Use a variety of platforms including websites, social media, and signage. Involve as many campus entities as possible in communicating these messages (housing, dining, recreation, etc.).
- Dental operations pose additional risks due to the frequency of aerosol-generating procedures and the inability of patients to use facial coverings. SHS with dental services should consult with Environmental Health and Safety professionals with appropriate expertise before considering reopening these services.

SHS Facility Considerations

- Make all efforts to segregate waiting areas for ill and well patient visits. If separate waiting rooms are not available, consider placing a tent outside or identifying a satellite space for patients with respiratory symptoms. Deploy signage providing clear guidance on how to proceed.
- Reconfigure all waiting and other clinic areas to promote physical distancing.
- Implement signage throughout the SHS communicating reasons for physical distancing.
- Ensure adequate alcohol-based (at least 60%) hand sanitizer, face protective face coverings (or coverings if protective face coverings are not available), tissues, and closed bins for disposal are available.
- Provide plexiglass/clear barriers between reception staff and waiting areas.
- Develop protocols for environmental management including clinic cleaning and decontamination. Assess air exchange for examination rooms and determine time required between uses in the event of a known or suspected COVID-19 patient.
- Ensure adequate IT network, wi-fi, hardware, and expertise to support telemedicine and telemental health visits.

SHS Administrative/Staff Considerations

- Add questions to satisfaction surveys to obtain feedback about telemedicine or phone visits.
- Ensure adequate PPE is available and that all staff are trained in its use. Monitor staff compliance with PPE use. Establish “par levels” (minimal acceptable PPE stores, also known as “safety stock”). PPE supplies should be stocked to meet both patient care and testing needs.
- Develop employee health program protocols for management of exposed and ill staff members. Document all providers and support staff involved in the care of every patient so that exposures can be tracked.
- Ensure staff are knowledgeable about COVID-19 symptoms, transmission, relevant protocols, and updated CDC guidance.
- Determine how SHS will handle work assignments for high-risk staff.
- Develop a financial model for campus leadership regarding potential costs and funding mechanisms for testing, contact tracing, and case management. Consider the future impact of antibody testing and mass vaccination.
- Develop plans for future mass immunization with influenza vaccine and COVID-19 vaccine, when available, including identifying supplies needed for both vaccines.
- Identify appropriate charges (if indicated) for visits, telehealth services, testing, and supplies including medications or vaccines. Identify correct billing codes to facilitate prompt, accurate reimbursement if billed to insurance.

Health Promotion

in-person cooking classes should be moved to a virtual format. The risk of many hands touching shared utensils in

The role of health promotion in a healthy campus is multi-layered and founded in a prevention framework.

Assessment, environmental change strategies, social marketing, social norming, peer education training, and health education programs are just a few components. Health promotion may also house alcohol and other drug (AOD) services including the collegiate recovery community, interpersonal violence (IPV) prevention, sexual health and STI resources, and nutrition services including a teaching kitchen.

There may be a range of changing restrictions placed on in-person events based on local public health conditions, so health promotion staff should develop a range of delivery methods. Many health education programs and trainings are easily transferable to a virtual environment. However, the integrity of some aspects may not be conducive to virtual delivery. In those instances, there simply is no replacement for in-person, hands-on interaction to optimally engage and stimulate learning. Placing as much content as feasible online could allow capacity for more frequent but smaller peer trainings or programs that are not conducive to the virtual setting.

Health promotion offerings carry various levels of risk based on the size, physical proximity of participants, nature of the activity, and vulnerability of the population. Health promotion professionals can consult with their campus or public health experts to develop a risk assessment and plan for various types of activities. In general, programmers should limit attendees to 10, practice physical distancing,

and begin each program with a brief instructional session reviewing hand hygiene, respiratory etiquette, symptoms of COVID-19, and staying home when sick. Attendees should continue to retain appropriate physical distancing and use face coverings during these onsite programs.

Individual visits for nutrition evaluations and counseling, AOD consultations, smoking cessation, health coaching, and sexual health education should be performed via telehealth until physical distancing restrictions are relaxed for the campus and local community. Case by case decisions on in-person interactions with students requesting IPV assistance or other sensitive discussions must weigh the needs of the student against the potential health impact on the staff. Any staff member with direct student encounters should be provided appropriate PPE and practice physical distancing.

In-person cooking classes have successfully been utilized in skill building and team building, as well as in branding and marketing. Until local public health conditions permit, the close quarters of a food preparation and food sharing environment outweighs the educational and social benefits of these activities. An alternative hybrid approach is a live cooking demonstration broadcast via social media or Zoom (or similar video conferencing service), which will still permit opportunities for interactive chats with campus dietitians, meal planning and prep, nutrition counseling, and small group workshops.

Health promotion has the unique capability of developing cogent relatable messages that speak to the spectrum of individuals on campus. Health promotion professionals should collaborate with SHS and the broader campus leadership teams and campus specialists to plan and implement communications and marketing efforts. These may include media campaigns, public service announcements, email blasts, editorials, op-ed articles, flyers, posters, billboards, public transportation signage, and workshops; specific strategies should be based on the capabilities and interests of the campus. All communication efforts should reinforce sound public health practices, utilize multiple media channels, be pilot tested in efficient ways, and maintain consistency across approaches. These efforts should be designed to reach students as well as the university's key stakeholders; each of these audiences represent an ultimate audience as well as an intermediary audience (e.g., a faculty member who is made aware of best practices and ways these can be incorporated into classroom assignments as well as day-to-day activities). This collaboration should engage campus specialty offices (e.g., marketing, and public relations) as well as faculty and academic departments (e.g., communication, marketing, public health).

Collaboration may also extend to statewide or regional coalitions so cost-effective approaches can be developed and shared among campuses.

Frequently, assessment and evaluation activities are delegated to health promotion. Health promotion professionals are well-versed in assessment and evaluation methodology as well as the broader context of health issues associated with this pandemic. Their expertise is invaluable in the campus-wide effort to inform and guide health and well-being initiatives. While health promotion staff cannot lead all assessment and evaluation activities, they can provide leadership regarding the short- and long-term assessment of the campus environment and campus climate; student behavior, attitudes, knowledge, perceptions, needs, interests, and intentions; faculty and staff awareness, attitudes, and needs; social norms and messaging effectiveness; programming and training impact; and other population level issues. Incorporating both quantitative and qualitative approaches is desirable. Engaging other specialists on campus (faculty and staff) will be helpful for garnering their expertise and providing opportunities for their students to gain experience.

Mental Health

Enormous efforts to establish physical distancing have resulted in both isolation and a change in routine for many persons. The emotional, social, and financial disruptions in combination with 24/7 media and fear and uncertainty surrounding this pandemic continue to take a toll on students' well-being, leading to concerns about increasing rates of depression, anxiety, substance use disorders, suicide, and domestic violence.

Many students are experiencing grief, disruption, and anxiety related to the changes. If students do not require psychotherapy, they may need an accessible, responsive venue for ongoing validation and support. Conversely, students with pre-existing depression, anxiety, and trauma are often more symptomatic during times of heightened stress and may require extra support in terms of more frequent contacts, sessions, and/or resources.

Telemental health has provided a path for mental health providers to continue providing services to students during the pandemic. In many college health settings, there has been a rapid and successful migration of counseling and mental health care to telemental health venues. Moving from telemental health back to in-person mental health services will be dependent on a variety of factors and for most operations will likely occur in stages. It is possible that mental health providers will never fully cease using effective telemental health programs established during the COVID-19 pandemic but will instead find an optimal balance between telemental health and in-person care.

As online enrollments are predicted to increase (due to health, disability accommodation, and/or financial needs of students and their families), campuses should make every effort to support telemental health care for enrolled students not physically present on campus. In addition, in order to fully serve all students who may need telemental health services, uniform standards and credentialing to practice across state lines will have to be established. The 2019 Higher Education Mental Health Alliance (HEMHA) *College Counseling From a Distance: Deciding Whether and When to Engage in Telemental Health Services* is an outstanding resource on telemental health in the higher education setting (see http://hemha.org/wp-content/uploads/2019/01/HEMHA-Distance-Counseling_FINAL2019.pdf).

Continued use of telemental health should be encouraged with the exception of those highly acute clients who meet exception criteria. In-person visits should be limited to those clients who would most benefit from such interactions. This could include crisis counseling, counseling for individuals unable to access telemental health, or other circumstances whereby the mental health professional believes an in-person visit carries significant benefit. Policies and procedures should clearly delineate which categories should receive an in-person vs. a telemental health appointment in order to facilitate appropriate scheduling. In order to maintain appropriate physical distance, waiting rooms may need to be modified or not allowed. If the size of the waiting room is an issue, services should be rendered by scheduled appointments only, no walk-ins allowed, or metered entrance to the clinic only at the appointment time. Integrated centers need to partner with health services for screening of all entrants to the clinic. Any staff member with direct student encounters should be provided appropriate PPE and practice physical distancing. Many of the patient and facilities considerations noted in the student health services section, such as limiting the use of high-touch areas or allowing online check-in, are applicable to mental health care as well.

Workshops, mindfulness, and other skill building programs could be placed in a virtual environment. Even group therapy visits could take place virtually. However, if the mental health provider deems the virtual environment to be subtherapeutic, the group could meet in person if there is space that allows for

appropriate physical distancing. The staff should provide clear instructions on staying home if sick, respiratory etiquette, and hand hygiene well in advance of the group session. At this time, personal face coverings would also be recommended.

Developing mechanisms for virtual drop-in sessions may address some of the increased demand for services.

Taking services to where the students are by establishing virtual "let's talk sessions" for students in specific divisional colleges/majors, residence halls, or groups allows for a sense of comradery and shared support.

Students also would benefit from ongoing virtual support venues in which they have access to needed education, resources, and self-help tools. A virtual platform, facilitated by counseling staff, to share experiences, connect with others, and feel supported and heard can be useful.

The health and well-being of student health and counseling staff, particularly those with direct patient contact must be preserved and protected. Staff members working in crisis settings tend to work many hours under

pressure with risk of infection, morbidity, and mortality. Recognition of signs and symptoms of burnout and provision of support to mitigate the possible psychosocial consequences of work in these situations through employee assistance programs or stress debriefing meetings is the obligation and responsibility of senior leadership.

This is a critical time to provide training and resources to faculty, staff, and students on how to identify those in distress and how to effectively intervene and refer appropriately. Counseling services staff can provide virtual trainings and workshops to provide the needed education, skills, confidence, and competence required (see <https://www.sprc.org/comprehensive-approach/identify-assist>).

Other Key Campus Areas

Campus-wide preparation is the key to an organized, effective, safety-focused, and medically informed process of reopening. Although student health services will play an important role, this effort will require the ongoing engagement of executive leadership (president/chancellor, provost, vice president of student affairs/campus life, other senior leaders) and the oversight and coordination of the institution's COVID-19 planning and response committee described in the *ACHA Guidelines: Preparing for COVID-19*.

While all areas of the college/university will require adjustments upon resuming operations, several key areas outside the classroom, such as housing, dining, athletics, and recreational sports, will require additional consideration.

Housing

Depending upon the size of the college/university, its residential housing inventory, and on-campus residency requirements, thousands to tens of thousands of students may live and dine on campus during periods of full in-person instruction. Students congregate, study, and socialize in these on-campus residential settings. Students often reside with two or more individuals per living space, with roommates from different parts of the country and world. In such settings, there will frequently be a mixture of individuals from low COVID-19 transmission areas and high-transmission areas living in a single space.

Clearly, it is difficult to maintain full physical distancing in on-campus housing, and even modified guidelines may be difficult to achieve. Considerations to decrease the risk for exposure within traditional residence halls, campus apartments/suites, campus fraternity/sorority houses, and other on-campus housing arrangements, include:

- Single resident per room and ideally per bathroom (if possible). This may be feasible only if the college/university has a limited number of students on campus for in-person instruction. When shared bathrooms are used, define the type and frequency of cleaning.
- Requirement of personal face coverings in common areas.
- Frequent reminders of proper hand hygiene (verbally, posters, videos) with hand sanitizer widely available in common areas and rooms.
- Enhanced cleaning in all common areas and high-touch surfaces, consistent with enhanced cleaning practices of other non-residential areas such as academic buildings. Custodial workers should be provided appropriate PPE and training consistent with their duties. See CDC guidelines for cleaning and disinfecting facilities (available at <https://www.cdc.gov/coronavirus/2019-ncov/community/reopen-guidance.html>).
- Widely shared/posted information in common areas about COVID-19 prevention. CDC provides communications resources such as posters, videos, and more at <https://www.cdc.gov/coronavirus/2019-ncov/communication/index.html>. Posted information should be updated as appropriate or with significant changes.
- Training on public health measures and signs/symptoms of COVID-19 for all live-in professionals, graduate hall directors, residence advisors (RA), and others in similar roles.
- Restrictions on events and social activities as per current physical distancing guidance. Reconfiguring seating in common areas to ensure proper physical distancing. Establish allowable occupancy and develop plans to monitor and enforce.
- Restrictions on building access by non-residents, including outside guests, non-residential staff, and others. These restrictions may not apply to some people, such as personal care attendants for students with disabilities.

Students with medical conditions such as asthma, diabetes, immunosuppressive drug therapy including chronic systemic corticosteroid treatment, heart disease, HIV, and morbid obesity are at high risk for COVID-19 illness and complications. The IHE must address whether these high-risk individuals should return to residence halls and other on-campus housing in the early phases of reopening the campus or later.

Housing/residence life, custodial, and other support staff are frequently on-call and are often the first responders to the needs of residential students. They need access to PPE, appropriate exercise and break opportunities, defined work schedules with time off as appropriate, and access to psychological/counseling support.

Isolation and Quarantine

Inevitably, a residential student will contract or be exposed to COVID-19 and will require isolation or quarantine. Campuses must proactively identify appropriate residential spaces and reserve those spaces in the event of needed isolation or quarantine of a student(s). If on-campus housing is nonexistent, unavailable, or unfeasible, the college/university should identify off-campus options for the isolation and quarantine of residential students. It is unreasonable to expect IHEs to provide on-campus isolation and quarantine housing for students who live off campus, but it is recommended that the IHE develop a plan for fielding requests for isolation/quarantine housing for off-campus students.

Ideally:

- A protocol should be made available to all individuals involved in the management of isolation spaces and its procedures.
- The isolation and quarantine rooms should be physically separated from other residential student rooms.
- The rooms should have private bathroom facilities and be stocked with a thermometer, sanitizing wipes, tissues, soap, hand sanitizer, and toiletries.
- Spaces should be labeled externally with appropriate signage that states restricted access (e.g., “Private Quarters” or “Authorized Personnel Only”) but does not state the reason for the restricted access due to concerns about potential for stigma and FERPA/ HIPAA violations. Any signage decisions should be reviewed with college/university general counsel. Minimally, a select group of individuals within housing/residence life, campus safety, and facilities should be aware of the rooms used for isolation.
- Adequate numbers of rooms should be pre-identified to accommodate an increase in need. CDC may later provide guidance on adequate numbers of rooms; if when that guidance is released, these ACHA recommendations will be updated.
- Student health services staff should remotely monitor students on a daily basis (temperature checks and symptom screening) and transfer to an on- or off-campus site for a clinical evaluation if symptoms advance or the patient requests.
- For students on the campus meal plan, dining services should arrange food delivery in collaboration with housing/residence life staff. Student affairs or campus life, in collaboration with housing/residence life staff, could arrange for the purchase of a campus meal plan or coordinate meal delivery for those students who have not purchased the campus meal plan.
- Counseling services and/or the office of spiritual and religious life should be available remotely to students in isolation or quarantine as needed.
- To the degree possible, students should continue academic activities remotely or be provided with note takers.
- A team of designated student affairs/campus life staff should be appropriately trained and on call to assist students with their personal needs (medication pickup, delivery of hygiene supplies, etc.).
- Transportation is made available to and from the location if medical care is needed.
- Custodial and maintenance staff and live-in professionals are provided with and overingto wear appropriate PPE (as per CDC guidelines) when cleaning or entering isolation and quarantine spaces (available at <https://www.cdc.gov/coronavirus/2019-ncov/hcp/infection-control-faq.html>).

All IHEs may not have the resources to meet each of these ideal recommendations but at a minimum should assess their capability to provide these accommodations for residential students in isolation or quarantine.

Many of these guidelines were developed in collaboration with the Association of College and University Housing Officers-International (ACUHO-I). Please visit the ACUHO-I website at <https://www.acuho-i.org/covid19> for additional COVID-19 resources for residence life administrators and staff.

Dining

On-campus dining services share many similarities with restaurants, but there are also a number of important differences that potentially impact the risk of COVID-19 transmission. In most campus dining services, students (faculty, staff, and visitors) queue up to enter, choose food options, and pay with cash, credit/debit cards or meal cards. Dining areas are often large and chaotic, with closely spaced tables and chairs and both sustained and episodic interpersonal interactions. As a result, significant changes will likely be necessary to institute physical distancing and other infection prevention and control measures. If a campus chooses to partially or fully resume campus dining services, they should consider:

- Requiring all dining facility staff to wear face protective face coverings and gloves at all times while working and interacting with the public.
- Providing custodial services with appropriate PPE for cleaning and disinfecting common, non-clinical spaces as per CDC guidelines (available at: <https://www.cdc.gov/coronavirus/2019-ncov/community/disinfecting-building-facility.html>).
- Requiring employees to follow infection prevention guidelines including:
 - Staying home when ill.
 - Practicing physical distancing whenever possible at work.
 - Practicing proper hand hygiene.
 - Avoiding touching the eyes, nose, and mouth with unwashed hands.
 - Cleaning and disinfecting frequently touched surfaces throughout the workday.
 - Undergoing temperature checks prior to shift.
- Strongly encouraging all customers/diners to wear face protective face coverings or coverings while in the facility. Since an individual cannot eat and drink while in a protective face covering, protective face coverings should be worn during movement in the facility and can be removed when sitting and dining. This further emphasizes the need for physical distancing of patrons and additional discussions of providing only takeout options during the initial phases of re-opening.
- Limiting the number of individuals dining in a single facility at one time. The number should be chosen with the goal to achieve appropriate physical distancing of diners. Possible approaches include:
 - Access control: once the target number is reached, patrons are only allowed to enter when another customer leaves.
 - Cohort dining: established dining times admitting a specific group of customers/diners.
 - Physically spaced (6-foot) floor markers for waiting lines outside and inside the facility.

- Appropriately spaced and limited numbers of tables and chairs per table.
- Eliminating buffet-style self-serve food or beverage stations and replacing with staff-served meal stations.
- Providing a bagged take-out meal option at every meal. Consider kosher, vegetarian, vegan, and gluten-free options, as requested or appropriate to the customer base.
- Arranging food delivery to students in isolation or quarantine.

Athletics

Many colleges/universities have hundreds of students participating in intercollegiate (varsity) sports. The novel COVID-19 virus presents a high risk of transmission in athletic settings due to frequent physical contact, potential for aerosolization during exercise, fomites (shared towels, water bottles, athletic equipment, balls/pucks), and the potential physical effects of over-training and dehydration on disease resistance.

Student athletes are first and foremost students. Athletics and sports medicine programs must ensure department policies, procedures, and communications regarding COVID-19 align with institutional, CDC, federal, state, tribal, territorial, or local public health guidelines and requirements.

In preparation for a partial or full resumption of intercollegiate athletics activities, including practice and competition, athletics and sports medicine programs should consider the following:

Creation of an Athletics COVID-19 Action Team:

Team members could include:

- Athletic director or designee.
- Head athletic trainer or designee.
- Head team physician or designee.
- Coaching representative.
- Strength and conditioning representative.
- Student health services representative.
- Counseling services representative.
- Student athlete.
- University crisis management/emergency preparedness representative.
- Health care system (academic medical center or local health care system) representative.
- Other potential ad hoc or advisory group representatives could include those from: recreation services, public health, facilities management, custodial services, compliance offices; equipment services; health promotion and well-being services, nutrition/dining services, housing, academics, human resources, campus safety, and athletic conference/governing bodies.

Creation of an Athletics and Sports Medicine COVID-19 Action Plan: This plan is a living document that is developed, reviewed, and updated by the Athletics COVID-19 Action Team and includes:

- Guidelines developed in conjunction with the campus COVID-19 planning and response committee regarding:
 - Personal protective equipment (PPE) and training for athletic trainers and custodial staff, including donning and doffing procedures.
 - Adequate availability of recommended PPE.
 - Recommended approach to Basic Life Support (BLS), resuscitation, and automated external defibrillator (AED) use in a student athlete/staff/spectator/patient with possible COVID-19.
- An assessment of the potential for COVID-19 transmission in each sport (e.g., individual vs. team sports; contact vs. non-contact sports; major spectator vs. limited spectator sports). Consider a phased return to athletics participation based on potential risk of transmission in each sport. Areas for consideration should include:
 - Sport-related impediments to personal distancing, which is unavoidable in many sports (e.g., wrestling, football, soccer, basketball, and other contact sports) and less common in others (e.g., golf, individual swimming events with appropriately spaced lanes, singles tennis).
 - Ball transfer during practice and competition (e.g., volleyball, basketball, soccer, baseball/softball, etc.).
 - Needs and feasibility of appropriate cleaning and disinfection in shared apparatus sports (e.g., gymnastics).
 - The difficulty/feasibility of “policing physical distancing” among spectators, even in a very small crowd and whether it is a task that athletics staff are able/willing to undertake.
- Pre-participation screening and evaluation of student athletes:
 - Consider addition of pre-participation questions regarding COVID-19 diagnosis, recent or current illness suggestive of COVID-19, exposure, current restrictions (isolation or quarantine), and/or current symptoms.
 - Carefully review each athlete for the presence of underlying health conditions that places the individual at higher risk for COVID-19.
 - Consider further evaluation of a student athlete based upon their questionnaire and recommendation of team physician or student health or primary care provider. Ensure onsite access to appropriate PPE in the event of a concerning student athlete questionnaire or screening.
 - Consider staggering pre-participation screening (rather than a single “mass screening event”), perhaps by team or by individual athlete appointments, to ensure physical distancing during waiting and examinations and allow cleaning of exam spaces between athletes.
 - Understand that scheduling changes could impact the immediate availability of individual athletes or teams upon return to campus.
 - At the time of publication of these guidelines, the question of COVID-19 testing of all intercollegiate athletes or other at-risk groups (noted on page 2) has not yet been settled. Given the current limitations of testing technology and interpretation of the results, it is clear that even

a combination of testing for both infection (nucleic acid or antigen testing) and immunity (serologic or antibody testing) cannot provide a comprehensive picture of the safety of the student athlete "herd." There will also be questions about the need for repeated testing and how often. IHEs and athletics programs are advised to continue carefully monitoring the recommendations of CDC, public health authorities, and professional organizations moving forward.

- Safe transition/acclimatization to athletic activity. Review adherence to NCAA governing body and sports medicine consensus recommendations for transition and acclimatization to activity following extended inactivity periods.
- Physical distancing principles in athletics. Consider recommendations for physical distancing in:
 - Athletics training room and other sports medicine health care facilities.
 - Athletics locker rooms.
 - Strength and conditioning facilities (including weight rooms). Will need to evaluate the spacing of equipment and use of a "sanitation station" at each equipment/exercise site so that cleaning can take place between each athlete, either by staff or the user.
 - Team meeting rooms.
 - Athletics academic areas.
 - Athletics dining areas.
 - High volume communal areas in athletics facilities, including spectator areas ("the stands," arenas, and stadiums).
- Recommendations for virtual team activities (e.g., team meetings). Whenever possible, these virtual activities should include athletes, coaches, and staff currently separated due to high-risk conditions, illness, or travel restrictions.
- Recommendations on use of personal face coverings (or surgical protective face coverings) in the athletics setting (including training rooms and sports medicine settings) that are consistent with CDC guidelines.
- Recommendations for non-touch temperature check prior to practice, training, and competition.
- Recommended steps in the transport, assessment, and testing of student athletes or staff with potential COVID-19 illness.
- Isolation and quarantine guidelines for student athletes:
 - Guidelines should be consistent with campus and CDC guidelines and procedures (see Housing recommendations).
 - Many student athletes live together in groups (e.g., off-campus apartments and houses), which may present issues for isolation and quarantine of individuals and groups.
 - Include contingency plan for onset of illness and/or exposure during athletics-related travel and competition.

- CDC guidelines for disinfecting non-emergency vehicles in the event of transport of an individual with diagnosed COVID-19 or a person under investigation (PUI) (available at <https://www.cdc.gov/coronavirus/2019-ncov/community/organizations/disinfecting-transport-vehicles.html>).
- Implementation of an athletics “shared responsibility” infection prevention plan, including:
 - Individual personal conduct consistent with prevention guidelines.
 - Signage about prevention based on CDC, campus, and other recommendations.
 - Hand sanitation stations (soap and water or 60% alcohol-based rub/hand sanitizer).
 - Annual prevention education and training for student athletes and staff.
- Guidelines for custodial services on appropriate techniques and PPE (as per CDC guidelines) for cleaning and disinfecting common, non-clinical spaces (available at: <https://www.cdc.gov/coronavirus/2019-ncov/community/disinfecting-building-facility.html>).
- Guidelines for both athletic trainers and custodial services on appropriate techniques and PPE (as per CDC guidelines) for cleaning and disinfecting training room and sports medicine health care spaces, including terminal cleaning (available at: <https://www.cdc.gov/coronavirus/2019-ncov/hcp/infection-control-faq.html>).
- Travel considerations: sports medicine staff should follow federal, state, local, and institutional public health recommendations related to screening and testing of student athletes and staff following team, work-related, and individual travel.
 - Considerations include travel to community or international “hot spots” and sports involved (contact vs. non-contact sports, team vs. individual sports).
 - Sports medicine staff should provide guidance regarding whether the proposed travel is appropriate given the current stage of the pandemic, potential isolation and quarantine measures that could arise as a result of the travel, and additional screening that may be required as a result of the travel.
- Contingency plans for illness, isolation, or quarantine of athletic trainers and other sports medicine staff. Consider minimum athletic trainer staffing levels for the safe continuation of team training and competition activities.

Provision of COVID-19 and infectious diseases education and training for athletics staff, including athletic trainers, coaches, strength and conditioning professionals, administration, facilities management, other departmental staff, and student athletes. The Athletics COVID-19 Action Team should recommend the timing (prior to return to campus) and continuing need throughout the academic year(s). The training should include:

- Details of COVID-19 signs, symptoms, evaluation, testing, course of illness, and transmission.
- Infection prevention and control concepts and procedures, including physical distancing, avoiding contact with ill individuals, and institutional screening procedures (if any).
- Individual personal conduct and hygiene.

Many of these guidelines were developed in collaboration with the National Athletic Trainers Association Intercollegiate Council for Sports Medicine (NATA- ICSM). For more college and

university resources, visit the NATA website at <https://www.nata.org/professional-interests/job-settings/college-university/resources>.

Recreational Programs, Facilities, and Club/Intramural Sports

Most campuses have recreation centers for students, faculty, and staff, and many include multiple and/or extensive indoor and outdoor (e.g., fields) facilities. Thousands of students participate in club and intramural sports, fitness classes and activities, aquatics, and other opportunities for physical activity. Research has shown positive effects of exercise on the immune system and many chronic diseases (including diabetes, obesity, and heart disease) that place individuals into higher risk groups for COVID-19. Exercise also has positive impacts on psychological well-being. However, these recreation centers and programs carry many of the same enhanced COVID-19 transmission risks that are potentially present in varsity sports and local health clubs. Therefore, recreation programs and services should:

- Align recreation services policies, procedures, and communication guidelines with institutional guidelines and CDC, federal, state, tribal, territorial, or local public health guidelines and requirements.
- Provide COVID-19 and infectious diseases education for recreation staff (professional and student), faculty, and instructors. Training should include:
 - Details of COVID-19 signs, symptoms, evaluation, testing, course of illness, and transmission.
 - Infection prevention and control concepts and procedures.
 - Individual personal conduct and hygiene.
 - The important personal and institutional responsibility to protect the health and safety of all students, faculty, and staff, including maximizing efforts to protect recreation, intramural, and club sport participants from COVID-19.
- Assess recreation and sports programs for their potential for COVID-19 transmission (e.g., individual vs. team sports; high intensity workouts with possible enhanced risk for aerosolization). Consider a phased return of sports and recreation programs based upon potential risk of transmission in a given activity.
- Consider informing the campus community, including parents, about COVID-19 prevention steps being taken by the recreation department. Be sure to carefully craft and vet any communications going to all or part of the campus community (see guidance under “Communications Plan”).
- Required protective face coverings as stated above in the USG directive, by coaches, instructors, recreation staff, and participants.
- Employ physical distancing measures in:
 - Locker rooms
 - Strength and conditioning facilities (e.g., weight rooms, cardio areas). As with athletics, consider the use of a “sanitation station” at each equipment/exercise site so that cleaning can take place between each athlete, either by staff or the user.

- Fitness and wellness classes.
- Lounge areas.
- Indoor and outdoor recreation facilities.
- Consider options to limit the maximum number of people in the facility with access control, use-by- appointment, or other measures.
- Consider starting or continuing to offer virtual recreation classes.
 - Feature signage about COVID-19 prevention (based on CDC, campus, or other recommendations) throughout the facilities.
 - Increase the availability of hand sanitation stations (soap and water or 60% alcohol-based rub/hand sanitizer) throughout the facilities, especially in high touch areas (elevators, stair rails, turnstiles).
 - Provide custodial services, athletic trainers, personal trainers and fitness instructors with guidelines for appropriate techniques and PPE (as per CDC guidelines) for cleaning and disinfecting common, non-clinical spaces, including recreation venues and equipment (available at: <https://www.cdc.gov/coronavirus/2019-ncov/community/disinfecting-building-facility.html>).

Many of these guidelines were developed in collaboration with National Intramural-Recreational Sports Association (NIRSA), Leaders in Collegiate Recreation. For more information about COVID-19 resources for recreational services professionals and their campus colleagues, visit the NIRSA website at <https://nirsa.net/nirsa/covid19/>.

Communications Plan

Regardless of size, a college/university must develop a communications plan when reopening the campus. Given the high stakes associated with reopening any IHE during the ongoing COVID-19 pandemic, it becomes vitally important to carefully craft and vet all communications to the campus community. Communications must convey the institution's confidence in the information, contain the institution's brand identity, send a unified message, and align with the core mission and values of the IHE.

The campus COVID-19 planning and response committee, a communications sub-committee, or the central communication/public relations team should oversee all messages, including messaging from the SHS. Student health, counseling, and health promotion/well-being leadership should engage early and often with the communications oversight group, as well as senior campus leadership, as they develop health and wellness messaging.

Information must always be credible, trustworthy, and up to date. Ideally, any document containing medical, science-based, epidemiologic and/or infection prevention and control messages should be reviewed by an individual with appropriate credentials or expertise. Information and recommendations will continue to evolve rapidly, and it is crucial to "get the science part right" in all communications.

Elements of Effective Messaging and Communication

Most or all IHEs have experience in crisis communications, and the basics of the approach will serve them well as they communicate about partial or full reopening in the face of the COVID-19 crisis.

Effective crisis messaging:

- Has unified content.
- Is consistent and reflects brand identity.
- Addresses the intended audiences' needs and (if appropriate) is delivered in multiple languages.
- Is appropriate in tone to the urgency of the communication. Calmness, confidence, and compassion should be evident in the message.
- Is timely, transparent, and clear.
- Is updated frequently and dated to reflect this timing.
- Resides on a single, easily accessible landing page on the institution's website.
- Is delivered through multiple platforms (website, social media, email, etc.).
- References additional resources (e.g., website, hot lines, FAQs for additional information).
- Is assessed and adjusted, as necessary.

While there are many issues to consider for communication pieces, it can be helpful to address the basics of “Who, What, When, Where, Why, and How.”

Who is the targeted audience?

- All students or only a subset of students (e.g., only undergraduates, only health science students, only student athletes)?
- The entire campus community, including faculty and staff?
- Students and parents?
- Trustees?
- Alumni?
- Local hospitals, health department, urgent care clinics?
- Visitors to campus—visiting teams, prospective students, visiting scholars and faculty, vendors, conference attendees, etc.?
- Off-site partners, community service facilities, internship locations?
- Local and national media via a press release?

The level of parental concern about COVID-19 will be extraordinarily high when the campus reopens. Including parents in key messaging is an excellent strategy to address their concerns and can be accomplished by inclusion in the main message or via a parent-targeted version. The most effective approach will vary significantly depending upon the target audience.

What is the purpose of the message?

- Define the main message. Including too many key points into a single communication piece makes it overly complex and long, which risks reader fatigue, inattention, and loss of the message.
- Limit to three or four main messages per communication piece. For example, the key messages could be “We will continue to do in-person care, telehealth, and telemental health once the campus reopens;” “This is how to access care during and after office hours;” and “For questions, here is

how you contact us.” If you also need to communicate about physical distancing in classrooms, residence halls and dining facilities, it is likely to be more effective in a separate message.

- Each message should include contact information for email and phone follow-up. Ensure staff are prepared to respond to concerns in a timely manner.

When should the message be sent?

- Some events will call for immediate notification of your audience(s), such as a sudden resurgence of COVID-19 illnesses on your campus.
- Urgent/important messages (e.g., a message in response to tragedy, such as the death of a community member) should be templated in advance, so that the language can be crafted, appropriately vetted, and available for immediate use.
 - The health services team should consider drafting key messages now for review and approval so they can be delivered to the campus in an orderly and timely manner.
 - The campus should consider developing a plan in advance for communicating about active cases as well as the death of a student, faculty, or staff member from COVID-19.
- Communications regarding policies, procedures, and strategies can be planned and scheduled for release more deliberately.
- Important messages should not be sent in the late evening, at night, or on Friday afternoon. Typically, questions regarding the communication will arise, and it is important to have someone available to respond.

Where will this message be housed?

Whether the message is an email, video, or press release, it should be featured in a format and location most readily accessible to the target audience, such as the campus website or social media sites.

Why is this message being sent?

Communications will serve several purposes including:

- To delineate action steps the IHE is taking to progressively reopen the campus.
- To share important safety measures.
- To describe specific approaches/instructions for subsets of the campus population (e.g., residential students, student athletes, health sciences students).
- To reassure the message’s recipients.

How will feedback and questions be addressed?

- Some messages, particularly those delivered urgently, may create a flurry of responses from the community, parents, and the media.
- Designate spokespersons in key areas to respond to media and individuals to answer phone and email inquiries using standardized and evidence-informed responses.
- Consider proactively engaging media (including campus, student, and local media), and prepare for contact from national press and communications organizations.

- Frequently asked questions (FAQs), or perhaps even recently asked questions (RAQs), can provide helpful, quickly accessible predetermined responses and should be posted prominently on the IHE's webpage.
- It is difficult to manage inaccurate information and rumors, particularly those circulating on social media. While some IHEs monitor key sites for misinformation and malicious content, many have concluded that the task is simply too big and social media is impossible to control. It is, however, worthy of discussion with the communications team.
- As the campus reopens, consider hosting monthly in-person or virtual leadership updates or town hall meetings. These updates could occur with greater frequency (weekly or bi-weekly) as conditions warrant. The president/chancellor, provost, or member of the COVID-19 response team could lead these sessions on emerging topics and continue to emphasize that the health and safety of the campus community is their highest priority.

International Travel

Currently, guidelines regarding international travel are very simple: **Avoid all nonessential travel globally.** This is detailed in the U.S. State Department's Level 4 Global Do Not Travel Advisory (<https://travel.state.gov/content/travel.html>) and the CDC Level 3 Global Travel Health Notice to avoid all nonessential travel (<https://www.cdc.gov/coronavirus/2019-ncov/travelers/index.html>).

Looking ahead to that time when international travel for IHE constituents resumes on a broader scale, protecting the health of the individual traveler as well as campus and local communities is of paramount importance. The following elements should be considered for all travelers embarking on IHE-related international travel, including students, faculty, and staff. These recommendations are based on current information and will be updated as the global COVID-19 situation evolves.

- Frequent, detailed communication among all involved parties is essential.
- Detailed travel plans and purposes should be fully disclosed prior to travel.
- All IHEs should establish comprehensive institution-wide policies regarding international travel recommendations, restrictions, and requirements for both outgoing and incoming travelers.
 - Policies should pertain to all IHE-related persons (students, faculty, and staff) who are planning international travel or returning from international travel.
 - Policies should be created collaboratively by appropriate parties (e.g., student health services, administration, office of international programs, risk management, and general counsel, as well as the state, tribal, territorial, or local health departments as appropriate).
 - Policies should be easily accessible, well-known to all affected parties, and enforceable.
 - Due to the variability of the global COVID-19 situation, policies should be reviewed regularly and revised as appropriate.
- Current, reliable, relevant resources must be provided to travelers prior to travel.
- A travel registry must be established for all international travel.
- Plans for reliable intra-travel communication and ability to identify travelers' locations is vitally important and must be in place prior to travel.

- Pre-travel orientations are essential and should contain current and relevant safety and health information, including emergency procedures.
- Greater consideration should be given to pre-travel health screenings due to health risks of the COVID- 19 pandemic.
- Appropriate health insurance should be mandatory for all travelers, including adequate evacuation coverage. IHEs should carefully review the details of insurance policies to ensure adequate coverage for planned activities as well as absence of pandemic exclusions.

Students, faculty, or staff who have been traveling internationally and are planning to re-enter the campus environment:

- Should be encouraged or required to communicate their intentions with identified contacts at their institutions in order to receive critical relevant information well in advance of their anticipated return.
- Must follow state, tribal, territorial, and local health department recommendations, and requirements.
 - At this time, this includes quarantine at home for 14 days, checking temperature twice a day, monitoring for onset of symptoms of COVID- 19, and maintaining contact with the appropriate health department as directed.
 - Directories of local (and tribal) health departments: <https://www.cdc.gov/publichealthgateway/healthdirectories/healthdepartments.html>
 - CDC returning traveler guidelines: <https://www.cdc.gov/coronavirus/2019-ncov/travelers/after-travel-precautions.html>

International Students, Faculty (Including Visiting Faculty), and Staff Who Are Incoming to or Present on Campus

There are many complex variables at play for our international students and colleagues planning travel in the ever-evolving global COVID-19 situation.

- It is crucial to inform our international students and colleagues of relevant, reliable, and current travel health and safety resources and to encourage the serious consideration of current recommendations prior to travel.
- Every international student, faculty, and staff member is in a unique situation, which warrants individually tailored recommendations.
- All new or returning international travelers should refer to CDC returning travelers guidelines and review CDC's "Travelers Prohibited from Entry to the U.S." (available at <https://www.cdc.gov/coronavirus/2019-ncov/travelers/from-other-countries.html>).
- Existing international students, faculty, and staff currently at an IHE in the U.S. who are considering travel to their home countries should review global travel restrictions as noted by the U.S. State Department and CDC (see above and in Resources).
- Faculty and staff contemplating travel with subsequent return to the U.S. to continue IHE studies or work must seriously consider:

- Current COVID-19 travel health risks and the possibility of significant unexpected changes in risks during their travels.
- Potential for abrupt disruption, cancellation, or other serious complications of planned return to the U.S. due to the COVID-19 pandemic.
- Rapidly changeable re-entry restrictions (including at any intermediate points in itinerary).

International travel is an evolving situation. Most IHEs in the U.S. have canceled or prohibited international travel for any university-related reasons through August 2020.

Fall study abroad programs and research-based travel are being scrutinized at an individual institutional level, and many have thus far postponed making definitive decisions. Incoming international students, faculty, and staff are faced with a multitude of uncertainties as well, and challenges and uncertainties abound in both host and home institutions and countries. Considering the multitude of unknown factors involved with this pandemic,

knowledge and resources to inform new international travel guidelines will emerge in the coming months, and ACHA will offer updates as appropriate.

Conclusion

COVID-19 has changed the health and safety of our nation and our college campuses dramatically. Easing the mitigation and physical distancing restrictions too soon will offset the progress we are starting to see in the U.S. and may precipitate an increase in spread of the virus, cause unnecessary deaths, overwhelm health care facilities, and prolong the economic crisis. Until specific and effective therapies and vaccines are available and widely used, campuses may need to continue to loosen or reinstate public health control measures throughout the pandemic.

A careful risk assessment and staged approach is needed to balance the benefits and potential harms of adjusting these measures, so as not to trigger a resurgence of COVID-19 cases and jeopardize the health and safety of the campus community.

Colleges and universities should implement incremental steps based on testing, surveillance, contact tracing, and the health care and campus infrastructure ability to handle a surge in order to lessen physical distancing. Changes should be guided by local, state, and regional data for both the state in which the IHE resides and nationally.

Understanding and considering the preparedness levels of the community and the campus and marshaling the IHE's considerable teaching, research, and student development expertise and resources will be critical to the success of resuming campus operations and mitigating the potential spread of the virus.

Resources

White House Guidelines—Opening Up America Again: <https://www.whitehouse.gov/wp-content/uploads/2020/04/Guidelines-for-Opening-Up-America-Again.pdf>

IDSA Policy and Public Health Recommendations for Easing COVID-19 Distancing Restrictions: https://www.idsociety.org/contentassets/9ba35522e0964d51a47ae3b22e59fb47/idsa-recommendations-for-reducing-COVID-19-distancing_16apr2020_final-.pdf

American Psychological Association Practice Resources in Response to COVID-19:
<https://www.apaservices.org/practice/clinic>

American Counseling Association, Counseling in a time of COVID-19:
<https://www.counseling.org/knowledge-center/mental-health-resources/trauma-disaster/mental-health-professional-counseling-and-emergency-preparedness>

Substance Abuse and Mental Health Services Association: <https://www.samhsa.gov/coronavirus>

Mental Health America: <https://mhanational.org/covid19#ForMentalHealthProviders>

American College Health Association:
<https://www.acha.org/COVID-19>

COVID-19 Task Force: Reopening Guidelines Committee

These guidelines were developed by the Reopening Guidelines Committee, part of ACHA's COVID-19 Task Force. A special thanks to the committee members: Jean Chin, MD, MBA, FACP, FACHA (Task Force and Committee Chair); Deborah Beck, MPA, EdD; Michael Deichen, MD, MPH; Catherine Ebelke, PA-C, CTH; Mike Huey, MD, FACHA; Cheryl Hug-English, MD, MPH; and Sarah Van Orman, MD, MMM.

Higher Education Mental Health Alliance (HEMHA) College Counseling from a Distance: Deciding Whether and When to Engage in Telemental Health Services: http://hemha.org/wp-content/uploads/2019/01/HEMHA-Distance-Counseling_FINAL2019.pdf

International Travel and COVID-19:

CDC Travel :
<https://www.cdc.gov/coronavirus/2019-ncov/travelers/index.html>

U.S. State Department Travel:
<https://travel.state.gov/content/travel/en/international-travel.html>

Many additional travel health related resources in ACHA Connect Travel Health Forum library (members only).

8455 Colesville Road, Suite 740 | Silver
Spring, MD 20910 | (410) 859-1500 |
www.acha.org

ARCHIVED
The COVID-19 Public Health Emergency Declaration ended at midnight on May 11, 2023.
Information for archival use only.

Attachment B



Coronavirus Disease 2019 (COVID-19)

Considerations for Institutes of Higher Education

Updated May 19, 2020

As some institutes of higher education (IHE) open in the United States, the Centers for Disease Control and Prevention (CDC) offers the following considerations for ways in which IHEs can help protect students and employees (e.g., faculty, staff, and administrators) and slow the spread of the Coronavirus Disease 2019 (COVID-19). IHEs vary considerably in geographic location, size, and structure. As such, IHE officials can determine, in collaboration with [state and local health officials](#), whether and how to implement these considerations while adjusting to meet the unique needs and circumstances of the IHE and local community. Implementation should be guided by what is feasible, practical, acceptable, and tailored to the needs of each community. Health facilities managed by the IHE may refer to CDC's [Guidance for U.S. Healthcare Facilities](#) and may find it helpful to reference the [Ten Ways Healthcare Systems Can Operate Effectively During the COVID-19 Pandemic](#). These considerations are meant to supplement—**not replace**—any state, local, territorial, or tribal health and safety laws, rules, and regulations with which IHEs must comply.

Guiding Principles to Keep in Mind

The more an individual interacts with others, and the longer that interaction, the higher the risk of COVID-19 spread. The risk of COVID-19 spread increases in IHE non-residential and residential (i.e., on-campus housing) settings as follows:

IHE General Settings

- **Lowest Risk:** Faculty and students engage in virtual-only learning options, activities, and events.
- **More Risk:** Small in-person classes, activities, and events. Individuals remain spaced at least 6 feet apart and do not share objects (e.g., hybrid virtual and in-person class structures or staggered/rotated scheduling to accommodate smaller class

sizes).

- **Highest Risk:** Full-sized in-person classes, activities, and events. Students are not spaced apart, share classroom materials or supplies, and mix between classes and activities.

IHE On-Campus Housing Settings

- **Lowest Risk:** Residence halls are closed, where feasible.
- **More Risk:** Residence halls are open at lower capacity and shared spaces are closed (e.g., kitchens, common areas).
- **Highest Risk:** Residence halls are open at full capacity including shared spaces (e.g., kitchens, common areas).

COVID-19 is mostly spread by respiratory droplets released when people talk, cough, or sneeze. It is thought that the virus may spread to hands from a contaminated surface and then to the nose or mouth, causing infection. Therefore, personal prevention practices (such as [handwashing](#), [staying home when sick](#)) and environmental prevention practices (such as [cleaning and disinfection](#)) are important principles that are covered in this document.

Fortunately, there are a number of actions IHE administrators can take to help lower the risk of COVID-19 exposure and spread.

Promoting Behaviors that Reduce Spread

IHEs may consider implementing several strategies to encourage behaviors that reduce the spread of COVID-19.

• **Staying Home or Self-Isolating when Appropriate**

- If a decision is made to have any version of in-person classes, before returning to campus, actively encourage students, faculty, and staff who have been sick with COVID-19 [symptoms](#), tested positive for COVID-19, or have been potentially [exposed](#) to someone with COVID-19 (either through [community-related exposure](#) or [international travel](#)) to follow CDC guidance to [self-isolate or stay home](#).
- Once back on campus, educate students, faculty, and staff on when they should [stay home or self-isolate](#) in their living quarters.
 - Actively encourage students, faculty, and staff who are sick or have recently had a [close contact](#) with a person with COVID-19 to stay home or in their living quarters (e.g., dorm room). Develop policies that encourage sick individuals to stay at home without fear of reprisals, and ensure students, faculty, and staff are aware of these policies. Offer virtual learning and telework options, if feasible.
 - Students, faculty, and staff should [stay home](#) when they have tested positive for or are showing [symptoms](#) of COVID-19.
 - Students, faculty, and staff who have recently had a [close contact](#) with a person with COVID-19 should also [stay home and monitor their health](#).
 - CDC's criteria can help inform return to work/school policies:
 - [If they have been sick with COVID-19](#)
 - [If they have recently had a close contact with a person with COVID-19](#)

• **Hand Hygiene and Respiratory Etiquette**

- Recommend and reinforce [handwashing](#) with soap and water for at least 20 seconds.
 - If soap and water are not readily available, hand sanitizer that contains at least 60% alcohol can be used.
- Encourage students, faculty, and staff to cover coughs and sneezes with a tissue or use the inside of your elbow. Used tissues should be thrown in the trash and hands washed immediately with soap and water for at least 20 seconds.
 - If soap and water are not readily available, hand sanitizer that contains at least 60% alcohol can be used.

• **Cloth Face Coverings**

- Recommend and reinforce use of [cloth face coverings](#) among students, faculty, and staff. Face coverings should be worn as feasible and are **most** essential in times when physical distancing is difficult. Individuals should be frequently reminded not to touch the face covering and to [wash their hands](#) frequently. Information should be provided to all students, faculty, and staff on [proper use, removal, and washing of cloth face coverings](#).
 - Note: [Cloth face coverings](#) should **not** be placed on:
 - Babies and children younger than 2 years old

- Anyone who has trouble breathing or is unconscious
- Anyone who is incapacitated or otherwise unable to remove the cover without assistance
- **Cloth face coverings** are meant to protect other people in case the wearer is unknowingly infected but does not have symptoms. **Cloth face coverings** are not surgical protective face coverings, respirators, or other medical personal protective equipment.

- **Adequate Supplies**

- Support **healthy hygiene** behaviors by providing adequate supplies, including soap, hand sanitizer containing at least 60 percent alcohol, paper towels, tissues, disinfectant wipes, cloth face coverings (as feasible), and no-touch/foot pedal trash cans.

- **Signs and Messages**

- Post **signs** in highly visible locations (e.g., building entrances, restrooms, dining areas) that promote everyday protective measures and describe how to stop the spread of germs (such as by properly washing hands and wearing a cloth face covering).

ARCHIVED
The COVID-19 Public Health Emergency Declaration ended at midnight on May 11, 2023.
Information for archival use only.

- Include messages (for example, [videos](#)) about behaviors that prevent spread of COVID-19 when communicating with faculty, staff, and students (such as on IHE websites, in emails, and on IHE [social media accounts](#)) in accordance with the [Clery Act](#) [?](#) .
- Find freely available CDC print and digital resources on CDC’s [communications resources](#) main page.

Maintaining Healthy Environments

IHEs may consider implementing several strategies to maintain healthy environments.

• **Cleaning and Disinfection**

- [Clean and disinfect](#) frequently touched surfaces (e.g., door handles, sink handles, drinking fountains, grab bars, hand railings, bathroom stalls, dining hall tables) within IHE facilities at least daily or between use as much as possible. Use of shared objects (e.g., lab equipment, computer equipment, desks) should be limited when possible, or cleaned between use.
- If transport vehicles (e.g., buses) are used by the IHE, drivers should practice all safety actions and protocols as indicated for other staff (e.g., hand hygiene, cloth face coverings). To clean and disinfect IHE buses, vans, or other vehicles, see guidance for [bus transit operators](#).
- Develop a schedule for increased, routine cleaning and disinfection.
- Ensure [safe and correct use](#) and storage of [cleaners and disinfectants](#) [?](#) , including storing products securely. Use products that meet [EPA disinfection criteria](#) [?](#) .
- Encourage students, faculty, and staff to keep their personal items (e.g., cell phones, other electronics) and personal work and living spaces clean. Encourage students, faculty, and staff to use disinfectant wipes to wipe down shared desks, lab equipment, and other shared objects and surfaces before use.
- Ensure there is adequate ventilation when using cleaning products to prevent students or staff from inhaling toxic fumes.

• **Shared Objects**

- Discourage sharing of items that are difficult to [clean or disinfect](#).
- Ensure adequate supplies to minimize sharing of high-touch materials to the extent possible (e.g., assigning each student their own art supplies, lab equipment, computers) or limit use of supplies and equipment by one group of students at a time and [clean and disinfect](#) between use.
- Avoid sharing electronic devices, books, pens, and other learning aids.

• **Ventilation**

- Ensure ventilation systems operate properly and increase circulation of outdoor air as much as possible, for example by opening windows and doors. Do not open windows and

doors if doing so poses a safety or health risk (e.g., risk of falling, triggering asthma symptoms) to students, faculty, or staff using the facility.

• **Water Systems**

- To minimize the risk of [Legionnaires' disease](#) and other diseases associated with water, [take steps](#) to ensure that all water systems and features (e.g., sink faucets, drinking fountains, decorative fountains) are safe to use after a prolonged facility shutdown. Drinking fountains should be cleaned and disinfected, but encourage faculty, staff and students to bring their own water to minimize use and touching of water fountains.

• **Modified Layouts**

- Space seating/desks at least 6 feet apart when feasible. For lecture halls, consider taping off seats and rows to ensure six-foot distance between seats.
- Host smaller classes in larger rooms.
- Offer distance learning in addition to in-person classes to help reduce the number of in-person attendees.
- Provide adequate distance between individuals engaged in experiential learning opportunities (e.g., labs, vocational skill building activities).
- Create [distance](#) between students in IHE vehicles (e.g., skipping rows) when possible.

• **Physical Barriers and Guides**

- Install physical barriers, such as sneeze guards and partitions, particularly in areas where it is difficult for individuals to remain at least 6 feet apart (e.g., cash registers).
- Provide physical guides, such as tape on floors or sidewalks and signs on walls to ensure that individuals remain at least 6 feet apart in lines and at other times.

• **Communal Spaces**

- Close shared spaces such as dining halls, game rooms, exercise rooms, and lounges if possible; otherwise, stagger use and restrict the number of people allowed in at one time to ensure everyone can stay at least 6 feet apart, and [clean and disinfect](#) between use.
- Add physical barriers, such as plastic flexible screens, between bathroom sinks and between beds especially when they cannot be at least 6 feet apart.
- For more information on communal spaces in student or faculty housing (e.g., laundry rooms, shared bathrooms and recreation areas) follow [CDC's guidance for Shared or Congregate Housing](#).

• **Food Service**

- Provide grab-and-go options for meals. If a cafeteria or group dining room is typically used, if possible, serve individually plated meals (versus buffet or any self-serve stations).
- Use disposable food service items (e.g., utensils, dishes). If disposable items are not feasible or desirable, ensure that all non-disposable food service items are handled with gloves and washed with dish soap and hot water or in a dishwasher. Individuals should

wash their hands after removing their gloves or after directly handling used food service items.

- If food is offered at any event, have pre-packaged boxes or bags for each attendee instead of a buffet or family-style meal. Avoid sharing food and utensils and consider the safety of individuals with food allergies.

Maintaining Healthy Operations

IHEs may consider implementing several strategies to maintain healthy operations.

• **Protections for Students, Faculty, and Staff at Higher Risk for Severe Illness from COVID-19**

- Offer options for faculty and staff at higher risk for severe illness (including older adults and people of all ages with certain underlying medical conditions) that limit their exposure risk (e.g., telework and modified job responsibilities).
- Offer options for students at higher risk for severe illness that limit their exposure risk (e.g. virtual learning opportunities).
- Consistent with applicable law, put in place policies to protect the privacy of people at higher risk for severe illness regarding underlying medical conditions in compliance with applicable federal and state privacy and confidentiality laws.

• **Regulatory Awareness**

- Be aware of state or local regulatory agency policies related to group gatherings to determine if events can be held.

• **Gatherings**

- Pursue virtual group events, gatherings, or meetings, if possible, and promote social distancing of at least 6 feet between people if events are held. Limit group size to the extent possible.
- Pursue options to convene sporting events and participate in sports activities in ways that reduce the risk of transmission of COVID-19 to players, families, coaches, and communities.
- Limit any nonessential visitors, volunteers, and activities involving external groups or organizations as possible – especially with individuals who are not from the local geographic area (e.g., community, town, city, or county).

• **Telework and Virtual Meetings**

- Encourage telework for as many faculty and staff as possible, especially employees at higher risk for severe illness from COVID-19.
- Replace in-person meetings with video- or tele-conference calls whenever possible.
- Provide student support services virtually, as feasible.
- When possible, use flexible work or learning sites (e.g., telework, virtual learning) and flexible work or learning hours (e.g., staggered shifts or classes) to help establish

policies and practices for social distancing (maintaining distance of approximately 6 feet) between people, especially if social distancing is recommended by state and local health authorities.

- **Travel and Transit**

- Consider options for limiting non-essential travel in accordance with state and local regulations and guidance.
- Encourage students, faculty and staff who use mass transit to consider using other transportation options (e.g., walking, biking, driving or riding by car- alone or with household members only) if feasible.

- **Designated COVID-19 Point of Contact**

- Designate an administrator or office to be responsible for responding to COVID-19 concerns. All IHE students, faculty and staff should know who this person is and how to contact them.

- **Participation in Community Response Efforts**

- Consider participating with state or local authorities in broader COVID-19 community response efforts (e.g., sitting on community response committees).

- **Communication Systems**

- Put systems in place for:
 - Consistent with applicable law and privacy policies, having students, faculty and staff report to the IHE if they have [symptoms](#) of COVID-19, a positive test for COVID-19, or were exposed to someone with COVID-

19 within the last 14 days in accordance with [health information sharing regulations for COVID-19](#)

[?](#) (e.g. see “Notify Health Officials and Close Contacts” in the **Preparing for When Someone Gets Sick** section below), and other applicable federal and state privacy and confidentiality laws, such as the Family Educational Rights and Privacy Act (FERPA).

- Notifying faculty, staff, students, families, and the public of IHE closures and any restrictions in place to limit COVID-19 exposure (e.g., limited hours of operation).

- **Leave (Time Off) and Excused Absence Policies**

- Implement flexible sick leave policies and practices that enable faculty, staff, and students to stay home or self-isolate when they are sick, have been exposed, or [caring for someone who is sick](#).
- Examine and revise policies for excused absences and virtual learning (students) and leave, telework, and employee compensation (employees).

- Leave and excused absence policies should be flexible, not be punitive to people for taking time off and should allow sick employees and students to stay home and away from others. Leave and excused absence policies should also account for employees and students who need to stay home with their children if there are school or childcare closures, or to care for sick family members.
- Develop policies for returning to classes and IHE facilities after COVID-19 illness. CDC’s criteria to [discontinue home isolation](#) and [quarantine](#) can inform these policies.

- **Back-Up Staffing Plan**

- Monitor absenteeism of employees and students, cross-train staff, and create a roster of trained back-up staff.

- **Staff Training**

- Train staff on all safety protocols
- Conduct training virtually or ensure that [social distancing](#) is maintained during training.

- **Recognize Signs and Symptoms**

- If feasible, conduct daily health checks or ask faculty, staff, and students to conduct self-checks (e.g., temperature screening and/or [symptom checking](#)).
- Health checks should be done safely and respectfully, and in accordance with any applicable federal or state [privacy and confidentiality laws and regulations](#). IHE administrators may use examples of screening methods found in CDC’s [General Business FAQs](#).

- **Sharing Facilities**

- Encourage any organizations that share or use IHE facilities to also follow these considerations.

- **Support Coping and Resilience**

- Encourage employees and students to take breaks from watching, reading, or listening to news stories, including social media if they are feeling overwhelmed or distressed.
- Promote employees and students eating healthy, exercising, getting sleep and finding time to unwind.
- Encourage employees and students to talk with people they trust about their concerns and how they are feeling.
- Consider posting signages for the national distress hotline: 1-800-985-5990, or text TalkWithUsto 66746

Preparing for When Someone Gets Sick

IHEs may consider implementing several strategies to prepare for when someone gets sick.

- **Advise Sick Individuals of Home Isolation Criteria**

- Sick faculty, staff, or students should not return to in-person classes or IHE facilities, or

end isolation until they have met CDC's [criteria to discontinue home isolation](#).

• **Isolate and Transport Those Who are Sick**

- Make sure that faculty, staff, and students know they should not come to the IHE if they are sick, and should notify IHE officials (e.g., IHE designated COVID-19 point of contact) if they become sick with COVID-19 [symptoms](#), test positive for COVID-19, or have been [exposed](#) to someone with COVID-19 symptoms or a confirmed or suspected case.
- Immediately separate faculty, staff, and students with COVID-19 [symptoms](#) (such as fever, cough, or shortness of breath). Individuals who are sick should go home or to a healthcare facility, depending on how severe their symptoms are, and follow [CDC Guidance for caring for oneself and others](#) who are sick. IHEs may follow [CDC's Guidance for Shared or Congregate Housing](#) for those that live in IHE housing.
- Work with IHE administrators and healthcare providers to identify an isolation room, area, or building/floor (for on-campus housing) to separate anyone who has COVID-19 symptoms or tests positive but does not have symptoms. IHE healthcare providers should use [Standard and Transmission-Based Precautions](#) when caring for sick people. See: [What Healthcare Personnel Should Know About Caring for Patients with Confirmed or Possible COVID-19 Infection](#).
- Establish procedures for safely transporting anyone who is sick to their home or to a healthcare facility. If you are calling an ambulance or bringing someone to the hospital, try to call first to alert them that the person may have COVID-19.

• **Clean and Disinfect**

- Close off areas used by a sick person and do not use these areas until after [cleaning and disinfecting](#)
- Wait at least 24 hours before cleaning and disinfecting. If 24 hours is not feasible, wait as long as possible. Ensure [safe and correct use](#) and storage of [cleaning and disinfection products](#) , including storing products securely away from children.

• **Notify Health Officials and Close Contacts**

- In accordance with applicable federal, state and local laws and regulations, IHEs should notify [local health officials](#), faculty, staff, and students immediately of any case of COVID-19 while maintaining confidentiality in accordance with the [Americans with Disabilities Act \(ADA\)](#) , FERPA or and other applicable laws and regulations.
- Inform those who have had [close contact](#) with a person diagnosed with COVID-19 to [stay home](#) or in their living quarters and [self-monitor for symptoms](#), and follow [CDC guidance](#) if symptoms develop.

Other Resources

[Latest COVID-19 information](#)

[Social Distancing](#)

[Cleaning and Disinfection](#)

[People at Higher Risk](#)

[Guidance for Business and Employers](#)

[Managing Stress and Coping](#)

[Shared and Congregate Housing](#)

[COVID-19 Frequently Asked Questions](#)

[Guidance for U.S. Healthcare Facilities](#)

[HIPAA and COVID-19](#)

[COVID-19 Prevention](#)

[CDC Communication Resources](#)

[Handwashing Information](#)

[Community Mitigation](#)

[Face Coverings](#)

[OSHA Guidance on Preparing Workplaces for COVID-19](#)

[5/19/20](#)

Page last reviewed: May 19, 2020 Content source: [National Center for Immunization and Respiratory Diseases \(NCIRD\), Division of Viral Diseases](#)

Attachment C

USG Coronavirus Disease 2019 (COVID-19) Implementation Guidance for Facilities Officers – Custodial Operations Focus

Environmental Cleaning and Disinfection Recommendations

Interim Recommendations for US Community Facilities Coronavirus Disease 2019

Bullets taken from <https://www.cdc.gov/coronavirus/2019-ncov/community/organizations/cleaning-disinfection.html>

Background

Based on what is currently known about the virus, spread from person-to-person happens most frequently among close contacts (within about 6 feet). This type of transmission occurs via respiratory droplets. Transmission of novel coronavirus to persons from surfaces contaminated with the virus has not been documented.

Timing and location of cleaning and disinfection of surfaces

- At a school, daycare center, office, or other facility o It is recommended to **close off areas used by the ill persons and wait as long as practical before beginning cleaning and disinfection**
 - o **Open outside doors and windows to increase air circulation in the area.** If possible, wait up to 24 hours before beginning cleaning and disinfection.
 - o **Cleaning staff should clean and disinfect all areas (e.g., offices, bathrooms, and common areas) used by the ill persons,** focusing especially on frequently touched surfaces.
 - o In areas where ill persons have visited or used, continue routine cleaning and disinfection as in this guidance.
 - o Bathrooms should be closed to anyone other than the cleaners during cleaning, so the major transmission vector, respiratory droplets, will be eliminated.

How to Clean and Disinfect Surfaces

- If surfaces are dirty, they should be cleaned using a detergent or soap and water prior to disinfection.
- For disinfection, diluted household bleach solutions, alcohol solutions with at least 70% alcohol, and most common EPA-registered household disinfectants should be effective.
 - o Diluted household bleach solutions can be used if appropriate for the surface. Follow manufacturer's instructions for application and proper ventilation. Check to ensure the product is not past its expiration date. Never mix household bleach with ammonia or any other cleanser. Unexpired household bleach will be effective against coronaviruses when properly diluted.

Personal Protective Equipment (PPE) and Hand Hygiene:

- **Cleaning staff should wear disposable gloves and gowns for all tasks in the cleaning process, including handling trash.**
 - o Gloves and gowns should be compatible with the disinfectant products being used.

- Additional PPE might be required based on the cleaning/disinfectant products being used and whether there is a risk of splash.
- Gloves and gowns should be removed carefully to avoid contamination of the wearer and the surrounding area. Be sure to **clean hands** after removing gloves.
- Gloves should be removed after cleaning a room or area occupied by ill persons. Clean hands immediately after gloves are removed.
- Cleaning staff should immediately report breaches in PPE (e.g., tear in gloves) or any potential exposures to their supervisor.
- **Cleaning staff and others should clean hands often**, including immediately after removing gloves and after contact with an ill person, by washing hands with soap and water for 20 seconds. If soap and water are not available and hands are not visibly dirty, an alcohol-based hand sanitizer that contains 60%-95% alcohol may be used. However, if hands are visibly dirty, always wash hands with soap and water.
- Follow normal preventive actions while at work and home, including cleaning hands and avoiding touching eyes, nose, or mouth with unwashed hands.
- Additional key times to clean hands include:
 - After blowing one's nose, coughing, or sneezing
 - After using the restroom
 - Before eating or preparing food
 - After contact with animals or pets
 - Before and after providing routine care for another person who needs assistance (e.g., a child)

Lastly and most importantly, new products claiming COVID 19 compliance should be vetted <https://www.americanchemistry.com/Novel-Coronavirus-Fighting-Products-List.pdf>

Note 1: PPE should be appropriate for the method and chemicals being used for cleaning. For example, if the space has been closed and unoccupied for at least 24 hours, in consultation with medical staff/local medical advisors, consider allowing cleaning staff to enter using gloves and processes used in BPP cleanup. Gowns are in short supply nationally and may be better allocated to staff using misters/active sprayers for disinfecting - more to protect the workers' clothes from the chemicals than from the virus. Many entities are waiting for more than the minimum 24 hours before entering, often 3 days, as over a weekend.

3/25/2020



Custodial protocol on sanitizing the health clinic

The custodian will be doing the following cleaning and sanitizing the health clinic on Monday through Friday from 5:00a.m.-2:00p.m. Below are the duties and roles of the custodian.

- Mop and sweep the floors
- Vacuum carpet then sprays the carpet with disinfectant afterwards
- Sanitize all counter tops
- Sanitize all doorknobs at the start of each shift
- Sanitize exterior doorknobs during the shift
- Wash and sanitize bathroom; restock paper dispensers as needed
- Sanitize the chairs in the lobby
- Clean and sanitizer windows and ledges
- Dispose of trash and empty trash receptacles

Please note that Emanuel Medical Center has installed their own soap and hand sanitizing dispensers. It is their responsibility to keep them filled and operational.

Student Health Clinic Staff Cleaning Procedures

Clinic staff perform standard cleaning of exam rooms after each visit, regardless of reason for visit. The cleaning solutions are appropriate for use with Covid-19 virus.

Any person with respiratory symptoms will be placed into a room as quickly as possible. All staff who enter must wear appropriate PPE. When the student leaves, the room will be cleaned using the above protocol.

Handwashing: Clean Hands Save Lives

When & How to Wash Your Hands

When and How to Wash Your Hands

[Español \(Spanish\)](#)



During the Coronavirus Disease 19 (COVID-19) pandemic, [keeping hands clean is especially important to help prevent the virus from spreading.](#)

Handwashing is one of the best ways to protect yourself and your family from getting sick. Learn when and how you should wash your hands to stay healthy.

How Germs Spread

Washing hands can keep you healthy and prevent the spread of respiratory and diarrheal infections from one person to the next. Germs can spread from other people or surfaces when you:

- Touch your eyes, nose, and mouth with unwashed hands
- Prepare or eat food and drinks with unwashed hands
- Touch a contaminated surface or objects



Blow your nose, cough, or sneeze into hands and then touch other people's hands or

objects

Key Times to Wash Hands

You can help yourself and your loved ones stay healthy by washing your hands often, especially during these key times when you are likely to get and spread germs:

- **Before, during, and after** preparing food
- **Before** eating food
- **Before and after** caring for someone at home who is sick with vomiting or diarrhea
- **Before and after** treating a cut or wound
- **After** using the toilet
- **After** [changing diapers or cleaning up a child who has used the toilet](#)
- **After** blowing your nose, coughing, or sneezing
- **After** touching an animal, animal feed, or animal waste
- **After** handling pet food or pet treats
- **After** touching garbage

During the COVID-19 pandemic, you should **also** clean hands:

- After you have been in a public place and **touched an item** or surface that may be frequently touched by other people, such as door handles, tables, gas pumps, shopping carts, or electronic cashier registers/screens, etc.
- Before touching your eyes, nose, or **mouth** because that's how germs enter our bodies.

Follow Five Steps to Wash Your Hands the Right Way

Washing your hands is easy, and it's one of the most effective ways to prevent the spread of germs. Clean hands can stop germs from spreading from one person to another and throughout an entire community— from your home and workplace to childcare facilities and hospitals.

Follow these five steps every time.

1. **Wet** your hands with clean, running water (warm or cold), turn off the tap, and apply soap.
2. **Lather** your hands by rubbing them together with the soap. Lather the backs of your hands, between your fingers, and under your nails.
3. **Scrub** your hands for at least 20 seconds. Need a timer? Hum the “Happy Birthday” song from beginning to end twice.
4. **Rinse** your hands well under clean, running water.

5. **Dry** your hands using a clean towel or air dry them.

Why? Read the science behind the recommendations.

Use Hand Sanitizer When You Can't Use Soap and Water

Washing hands with soap and water is the best way to get rid of germs in most situations. If soap and water are not readily available, you can use an alcohol-based [hand sanitizer](#) that contains at least 60% alcohol. You can tell if the sanitizer contains at least 60% alcohol by looking at the product label.

Sanitizers can quickly reduce the number of germs on hands in many situations. However,

- Sanitizers do **not** get rid of all types of germs.
- Hand sanitizers may not be as effective when hands are visibly dirty or greasy.

You can use an alcohol-based hand sanitizer that contains at least 60% alcohol if soap and water are not available.

- Hand sanitizers might not remove harmful chemicals fr

How to use hand sanitizer

- Apply the gel product to the palm of one hand (read the label to learn the correct amount).
- Rub your hands together.
- Rub the gel over all the surfaces of your



Caution! Swallowing alcohol-based hand sanitizers can cause alcohol poisoning if more than a couple of mouthfuls are swallowed. [Keep it out of reach of young children and supervise their use.](#)



hands and fingers until your hands are dry. This should take around 20 seconds.

CDC's Handwashing Campaign: *Life is Better with Clean Hands*

CDC's *Life is Better with Clean Hands* campaign encourages adults to make handwashing part of their everyday life and encourages parents to wash their hands to set a good example for their kids. Visit the [Life is Better with Clean Hands](#) campaign page to download resources to help promote handwashing in your community.

For more information on handwashing, visit CDC's [Handwashing website](#) or call 1-800-CDC-INFO.

More Information

- [Handwashing: Clean Hands Save Lives](#)
- [Life is Better with Clean Hands Campaign](#)
- [Preventing the Flu](#)
- [Hand Hygiene in Healthcare Settings](#)
- [Hand Hygiene After a Disaster](#)
- [Water-Related Hygiene](#)
- [Keeping Your Hands Clean on a Cruise](#)

Use of Cloth Face Coverings to Help Slow the Spread of COVID-19

How to Wear Cloth Face Coverings

Cloth face coverings should—

- fit snugly but comfortably against the side of the face
- be secured with ties or ear loops
- include multiple layers of fabric
- allow for breathing without restriction
- be able to be laundered and machine dried without damage or change to shape

CDC on Homemade Cloth Face Coverings

CDC recommends wearing cloth face coverings in public settings where other social distancing measures are difficult to maintain (e.g., grocery stores and pharmacies), **especially** in areas of significant community-based transmission.

CDC also advises the use of simple cloth face coverings to slow the spread of the virus and help people who may have the virus and do not know it from transmitting it to others. Cloth face coverings fashioned from household items or made at home from common materials at low cost can be used as an additional, voluntary public health measure.

Cloth face coverings should not be placed on young children under age 2, anyone who has trouble breathing, or is unconscious, incapacitated or otherwise unable to remove the cloth face covering without assistance.

The cloth face coverings recommended are not surgical protective face coverings or N-95 respirators. Those are critical supplies that must continue to be reserved for healthcare workers and other medical first responders, as recommended by current CDC guidance.

Should cloth face coverings be washed or otherwise cleaned regularly? How regularly?



Yes. They should be routinely washed depending on the frequency of use.

How does one safely sterilize/clean a cloth face covering?

A washing machine should suffice in properly washing a cloth face covering.

How does one safely remove a used cloth face covering?

Individuals should be careful not to touch their eyes, nose, and mouth when removing their cloth face covering and wash hands immediately after removing.



CS316353B 04/10/2020, 8:07 PM



Sewn Cloth Face Covering

Materials

- Two 10" x 6" rectangles of cotton fabric
- Needle and thread (or bobby pin)
- Scissors
- Sewing machine
- Two 6" pieces of elastic (or rubber bands, string, cloth strips, or hair ties)

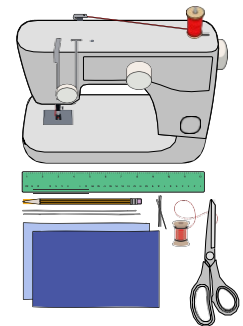

Tutorial

1. Cut out two 10-by-6-inch rectangles of cotton fabric. Use tightly woven cotton, such as quilting fabric or cotton sheets. T-shirt fabric will work in a pinch. Stack the two rectangles; you will sew the cloth face covering as if it was a single piece of fabric.

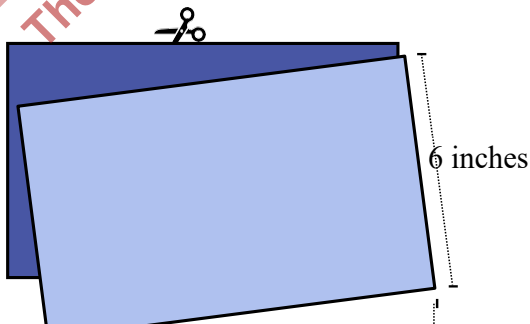

2. Fold over the long sides 1/4 inch and hem. Then fold the double layer of fabric over 1/2 inch along the short sides a

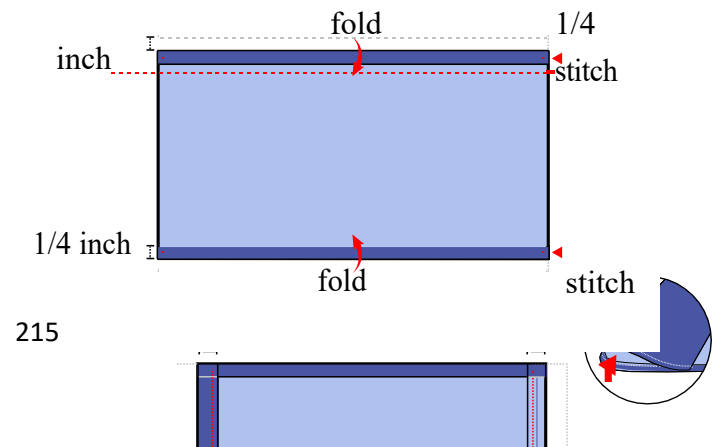

10 inches

fold

1/2 inch

1/2 inch

stitch

stitch

3. Run a 6-inch length of 1/8-inch wide elastic through the wider hem on each side of the cloth face covering. These will be the ear loops. Use a large needle or a bobby pin to thread it through. Tie the ends tight.

Don't have elastic? Use hair ties or elastic head bands. If you only have string, you can make the ties longer and tie the cloth face covering behind your head.

4. Gently pull on the elastic so that the knots are tucked inside the hem. Gather the sides of the cloth face covering on the elastic and adjust so the protective face covering fits your face. Then securely stitch the elastic in place to keep it from slipping.

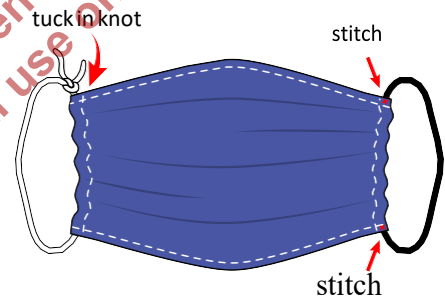
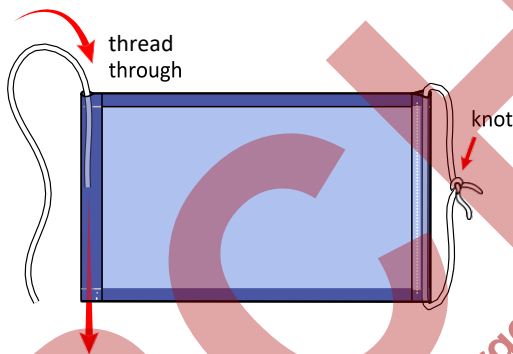

Quick Cut T-shirt Cloth Face Covering (no sew method)

Materials

- T-shirt
- Scissors

Tutorial

1.

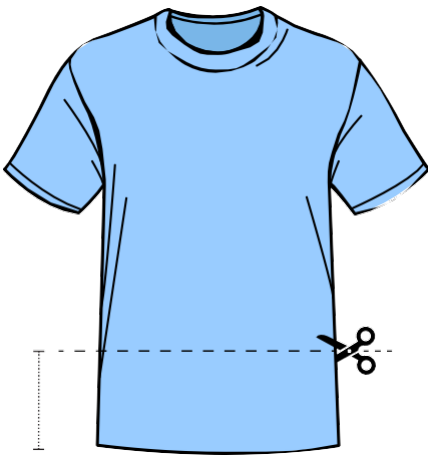

7-8 inches

2.

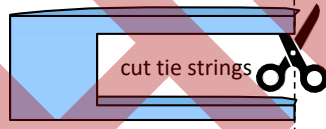
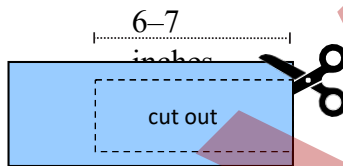

3.

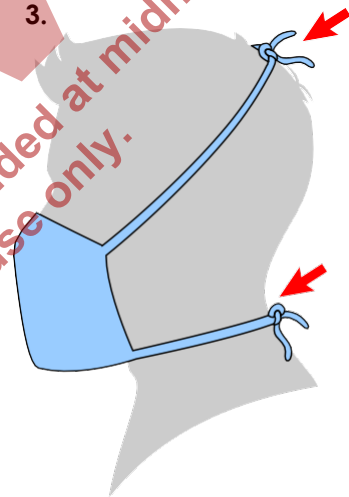

Tie strings around neck, then over top of head.

Bandana Cloth Face Covering (no sew method)

Materials

- Bandana (or square cotton cloth approximately 20"x20")
- Rubber bands (or hairties)

- Scissors (if you are cutting your own cloth)

Tutorial

1.

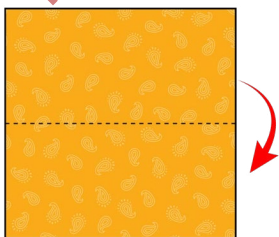

2.

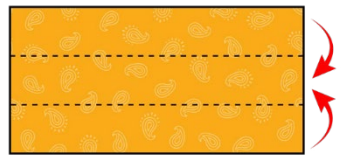

217

3.



Fold bandana in half.

4.

Fold side to the middle and tuck.

Fold top down. Fold bottom up.

5.



ARCHIVED
The COVID-19 Public Health Emergency Declaration ended at midnight on May 11, 2023.
Information for archival use only.

Place rubber bands or hair ties about 6 inches apart.

6.

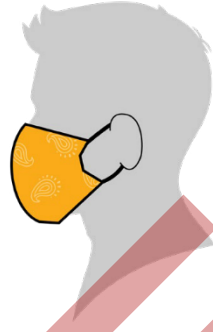

ARCHIVED
The COVID-19 Public Health Emergency Declaration ended at midnight on May 11, 2023.
Information for archival use only.

Appendix F

Mayo Clinic COVID-19 Self-Assessment Tool*

Have you been within 6 feet of a person with a lab-confirmed case of COVID-19 for at least 5 minutes, or had direct contact with their mucus or saliva, in the past 14 days?

Yes

No

Does the person with COVID-19 live with you?

Yes

No

In the last 48 hours, have you had any of the following NEW symptoms?

Check all that apply.

- Fever of 100.5 F (38 C) or above, or possible fever symptoms like alternating chills and sweating
- Cough
- Trouble breathing, shortness of breath or severe wheezing
- Chills or repeated shaking with chills
- Muscle aches
- Sore throat
- Loss of smell or taste, or a change in taste
- Nausea, vomiting or diarrhea
- Headache
- None of the above

Do you have any of the following possible emergency symptoms?

Check all that apply.

- Struggling to breathe or fighting for breath even while inactive or when resting
- Feeling about to collapse every time you stand or sit up (floppiness or a lack of response in a child under age 2)
- None of the above

Symptoms of COVID-19 include new:

- Fever
- Cough or sore throat
- Shortness of breath or trouble breathing
- Chills or repeated shaking with chills
- Muscle aches
- Nausea, vomiting or diarrhea
- Loss of smell or taste, or a change in taste
- Headache

Call 911 or your local emergency number immediately if you develop symptoms like:

- Ongoing pain or pressure in your chest
- New confusion
- A bluish color to your lips or face
- Struggling to breathe
- Feeling about to collapse every time you stand or sit up

If your health care provider suspects or confirms that you have COVID-19:

- Don't leave your home, except to get medical care, until cleared by your health care provider.
- Stay in a specific room away from others in your home, and use a separate bathroom, if possible.

*This tool appears as a fillable form: <https://www.mayoclinic.org/COVID-19-self-assessment-tool>

Appendix G

Guidance to Supervisors Regarding Employees Reports of Illness During COVID -19 Pandemic

6/29/20

Updated 7/11/2020

This guidance is provided to assist you in implementing EGSC's (EGSC's) employee policies and procedures concerning employee illness and absences during COVID-19. During this time, it is important that EGSC take appropriate precautionary measures concerning employee illness and absence to ensure the safety of all employees and students. The following reporting procedures provide an illness and absence reporting mechanism for supervisors that will enable EGSC to monitor its response to COVID-19.

1. Employees on campus are required to use face coverings as provided in the above USG directive, practice social distancing of at least 6 feet, wash hands frequently, and keep spaces and equipment clean using appropriate sanitation methods. All meetings must be held by conference call or electronically (Zoom, Skype, etc.).
2. Illness with COVID-like symptoms and/or exposures to COVID-19 may arise in off campus and on campus settings, such as:
 - An employee calls in sick from home and reports illness with COVID-like symptoms or possible exposure to COVID-19
 - An employee is on campus and reports feeling ill with COVID-like symptoms
 - An employee reports that a co-worker who is on campus has disclosed that the co-worker is feeling ill with COVID-like symptoms and supervisor had verified this with the sick employee

Mitigations for these are:

- If the employee is off campus, that employee will be instructed to seek medical care and not to report to work until providing clearance from his/her medical provider to return to work.
 - If the employee is on campus, that employee will be instructed to leave and to seek medical care. If the illness is later confirmed positive for COVID-19, the employee should notify HR. That employee must complete quarantine guidelines and cannot return to campus until clearance is provided from his/her medical provider to return to work.
 - In both cases, the supervisor will complete the EGSC COVID-19 Possible Exposures Form, notify EGSC HR, and send the form to the EGSC President. The EGSC President will send the form to HR.
 - HR is responsible for tracking the employee using the EGSC COVID-19 Possible Exposures Form from initial report through return to work.
 - If the employee is on campus, the employee's workspace will be cleaned per CDC guidelines.
3. When other employees have had **close contact** with an employee on campus that has tested positive for COVID-19, has a possible COVID-19 exposure or has illness with COVID-like symptoms and these occurred within the last two days, the supervisor will complete the EGSC COVID-19 Possible Exposures Form, notify EGSC HR, and send the form to the EGSC President. EGSC will implement the following mitigation measures:
 - Those employees should be sent home and instructed to seek medical care and not to report to work until providing clearance from his/her medical provider to return to work.
 - **Close contact is defined as face to face interaction of less than 6 feet for greater than 15 minutes at one time.** Per CDC, "recommendations vary on the length of time of exposure, but 15 minutes of close exposure can be used as an operational definition. Brief interactions are less likely to result in transmission; however, symptoms and the type of interaction (e.g., did the infected person cough directly into the face of the exposed individual) remain important." (<https://www.cdc.gov/coronavirus/2019-ncov/php/public-health-recommendations.html>)
 - At any time, if an employee tests positive for COVID-19 he/she should report to HR and should not return to campus until providing clearance from his/her medical provider to return to work.
 - If the employee is sent home due to close contact with an individual that subsequently tests negative for COVID-19, upon notice to EGSC-HR, the employee will be released to return to work.
 4. In the event of suspected or actual COVID-19 illness, the Director of Human Resources will send a letter to each identified employee with information regarding leave, self-care and quarantine per GDPH guidelines, free COVID-19 screening, and return to work deadline and conditions, as appropriate.
 5. Quarantined and/or ill employees will maintain in contact with his or her immediate supervisor and EGSC HR while on leave / quarantine.

Appendix H

Vendor Acknowledgement and Waiver

COVID-19 HEALTH AND SAFETY PROTOCOLS

EGSC (EGSC) is monitoring public access to the campus due to COVID-19. COVID-19 is a highly contagious virus that can spread from person to person. In response to this threat, EGSC has implemented prevention practices for faculty, staff, students, and vendors while on campus. All individuals on campus are expected to follow the EGSC health and safety protocols. It is the personal responsibility of all persons on campus to follow the protocols for the health and safety of themselves and others on campus.

EGSC has adopted the Centers for Disease Control's *How to Stop the Spread* as its health and safety protocol (attached). Please review this document carefully as it sets forth EGSC's behavioral expectations while on campus. Please indicate your reason for being on campus by completing the form below.

By signing below, I acknowledge that I have read the Centers for Disease Control's *How to Stop the Spread*, agree to follow the instructions while on campus and hereby waive liability, release and forever discharge EGSC, the Board of Regents of the USG, its members individually, and its officers, agents, and employees, and the Georgia Tort Claims Trust Fund, of and from any and all claims, demands, rights and causes of action of whatever kind or nature arising out of all known and unknown, foreseen and unforeseen bodily and personal injury, resulting from or in any way connected with the my work as a vendor on campus during the COVID-19 pandemic.

This acknowledgment and waiver will be valid for the period covering vendors on campus duties, not to exceed one year from date of signing.

Signature

Print Name: _____

Date: _____

Campus Business:

Vendor: _____ (Name of company)

5/20/20



Attachment I

EGSC

COVID-19 HEALTH AND SAFETY PROTOCOLS

ACKNOWLEDGMENT AND PLEDGE OF PERSONAL RESPONSIBILITY

EGSC is monitoring public access to the campus due to COVID-19. COVID-19 is a highly contagious virus that can spread from person to person. In response to this threat, EGSC has implemented prevention practices for faculty, staff, students, parents/guardians, and vendors while on campus. All individuals on campus are expected to follow the EGSC health and safety protocols. It is the personal responsibility of all persons on campus to follow the protocols for the health and safety of themselves and others on campus.

EGSC has adopted the Centers for Disease Control's *How to Stop the Spread* as its health and safety protocol (attached). Please review this document carefully as it sets forth EGSC's behavioral expectations while on campus.

ARCHIVED
The COVID-19 Public Health Emergency Declaration ended at midnight on May 11, 2023.
Information for archival use only.



Coronavirus Disease 2019 (COVID-19)

People Who Are at Increased Risk for Severe Illness

Updated June 25, 2020

[Print Page](#)

Everyone is at risk for getting COVID-19 if they are exposed to the virus. Some people are more likely than others to become severely ill, which means that they may require hospitalization, intensive care, or a ventilator to help them breathe, or they may even die. We learn more about COVID-19 every day, and as more information becomes available, CDC will continue to update and share information about risk for severe illness.

[People at increased risk for severe illness](#)

[Older Adults](#)

[People with Underlying Medical Conditions](#)

COVID-19: Are You at Higher Risk for Severe Illness?

Additional Resources

[ASL Video Series: COVID-19: Are You at Higher Risk for Severe Illness?](#)

[Learn how you can help protect yourself if you are at higher risk of severe illness from COVID-19](#)

Page last reviewed: June 25, 2020

COVID-2019 Menu

- [Coronavirus Home](#)
- [Your Health](#)
- [Community, Work & School](#)
- [Healthcare Workers](#)
-  [Laboratories](#)
- [Health Departments](#)
-  [Cases, Data & Surveillance](#)
- [More Resources](#)

Coronavirus Disease 2019 (COVID-19)

Older Adults

Updated June 25, 2020

[Print Page](#)

Among adults, the risk for severe illness from COVID-19 increases with age, with older adults at highest risk.

Severe illness means that the person with COVID-19 may require hospitalization, intensive care, or a ventilator to help them breathe, or they may even die.

Risk for Severe Illness Increases with Age

As you get older, your risk for severe illness from COVID-19 increases. For example, people in their 50s are at higher risk for severe illness than people in their 40s. Similarly, people in their 60s or 70s are, in general, at higher risk for severe illness than people in their 50s. The greatest risk for severe illness from COVID-19 is among those aged 85 or older.

There are also other factors that can increase your risk for severe illness, such as having [underlying medical conditions](#). By understanding the factors that put you at an increased risk, you can make decisions about what kind of precautions to take in your daily life.

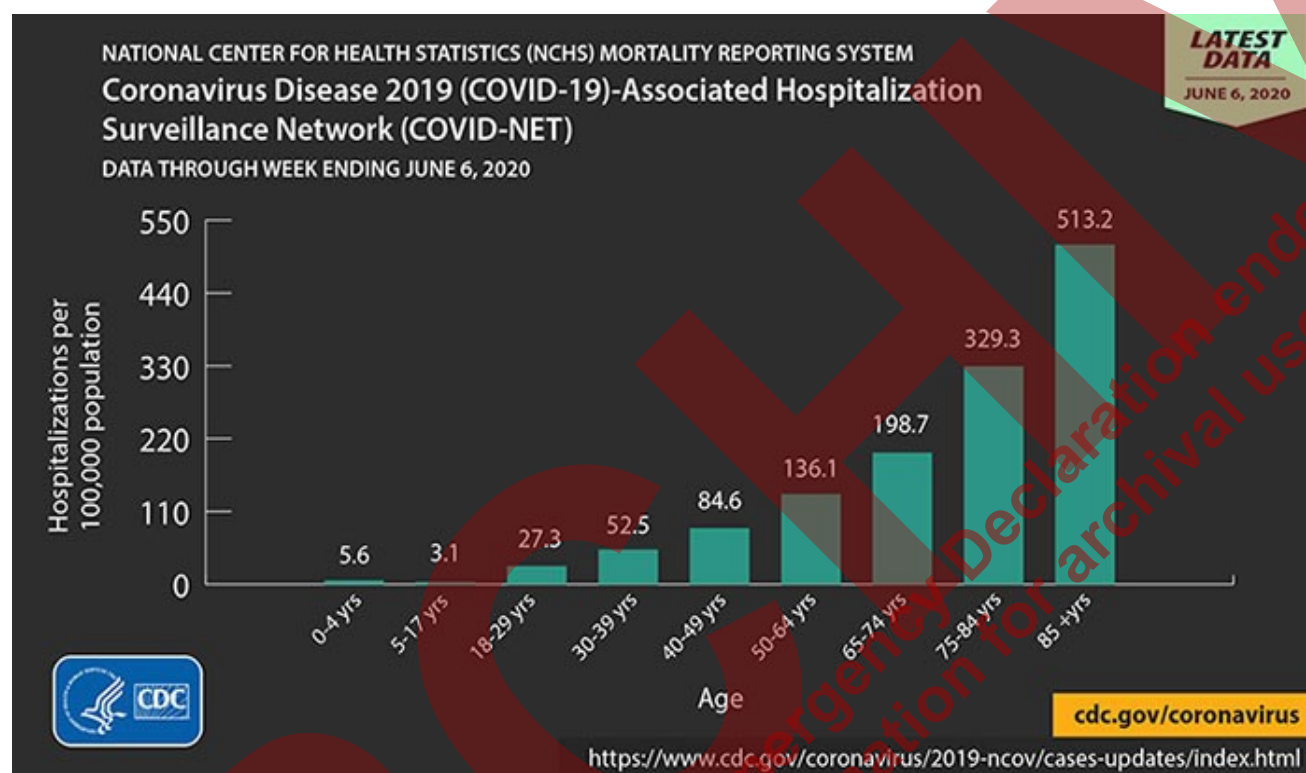

Everyone, especially older adults and others at increased risk of severe illness, should take [steps to protect themselves](#) from getting COVID-19.

In general, your risk of getting severely ill from COVID-19 increases as you get older. In fact, 8 out of 10 COVID-19-related deaths reported in the United States have been among adults aged 65 years and older.

CDC Has Information For Older Adults at Higher Risk

8 out of **10** COVID-19 deaths reported in the U.S. have been in adults 65 years old and older. Visit [CDC.gov/coronavirus](https://www.cdc.gov/coronavirus) for steps to reduce your risk of getting sick.



[cdc.gov/coronavirus](https://www.cdc.gov/coronavirus)



ARCHIVED
The COVID-19 Public Health Emergency Declaration ended at midnight on May 11, 2023.
Information for archival use only.

Reduce your risk of getting COVID-19.

It is especially important for people at high risk of severe illness from COVID-19, and those who live with them, to protect themselves from getting COVID-19.

The best way to protect yourself and to help reduce the spread of the virus that causes COVID-19 is to:

- Limit your interactions with other people as much as possible.
- Take [precautions to prevent getting](#) COVID-19 when you do interact with others.

If you start feeling sick and think you may have COVID-19, get in touch with your healthcare provider within 24 hours

Venturing out into a public setting? What to consider before you go.

As communities and businesses across the United States are opening, you may be thinking about [resuming some activities](#), [running errands](#), and attending [events and gatherings](#). There is no way to ensure you have zero risk of infection.

People at increased risk of severe illness from COVID-19, and those who live with them, should consider their level of risk before [deciding to go out](#) and ensure they are taking steps to [protect themselves](#). Consider avoiding activities where taking protective measures may be difficult, such as activities where social distancing can't be maintained. **Everyone should take steps to prevent getting and spreading COVID-19 to protect themselves, their communities, and people who are at increased risk of severe illness.**

In general, the more people you interact with, the more closely you interact with them, and the longer the duration, the higher your risk getting and spreading COVID-19.

- If you decide to engage in public activities, continue to protect yourself by [practicing everyday preventive actions](#).
- Keep these items on hand and use them when venturing out: a cloth face covering, tissues, and a hand sanitizer with at least 60% alcohol, if possible.
- If possible, avoid others who are not wearing [cloth face coverings](#) or ask others around you to wear cloth face coverings.

Are you considering in-person visits with family and friends? Here are some things to consider to help make your visit as safe as possible.

When to delay or cancel a visit

- Delay or cancel a visit if you or your visitor has [symptoms](#) of COVID-19 or have been exposed to someone with COVID-19 in the last 14 days.
- Anyone who has had [close contact](#) with a person with COVID-19 should [stay home and monitor for symptoms](#).

In general, the more people you interact with, the more closely you interact with them, and the longer that interaction, the higher the risk of COVID-19 spread

- How many people will you interact with?
- Can you keep 6 feet of space between you and others? Will you be outdoors or indoors?
- What's the length of time that you will be interacting with people?

Encourage social distancing during your visit

- Visit with your friends and family outdoors when possible. If this is not feasible, make sure the room or space is well-ventilated (for example, open windows or doors) and large enough to accommodate [social distancing](#).
- Arrange tables and chairs to allow for social distancing. People from the same household can be in groups together and don't need to be 6 feet apart from each other.
- Consider activities where social distancing can be maintained, like sidewalk chalk art or yard games.
- Try to avoid close contact with your visitors. For example, don't shake hands, elbow bump, or hug. Instead wave and verbally greet them.
- If possible, avoid others who are not wearing cloth face coverings or ask others around you to wear cloth face coverings.
- Consider keeping a list of people you visited or who visited you and when the visit occurred. This will help with [contact tracing](#) if someone becomes sick.

Wear cloth face coverings

- **Cloth face coverings** should be worn over the nose and mouth. Cloth face coverings are especially important when it is difficult to stay at least 6 feet apart from others or when people are indoors to help protect each other.
- Cloth face coverings may slow the spread of the virus and help people who may have the virus and do not know it from transmitting it to others
 - Wearing a cloth face covering helps protect others in case you're infected, while others wear one to protect you should they be infected.
- **Who should NOT use cloth face coverings**
Children under age 2 or anyone who has trouble breathing, is unconscious, or is incapacitated or otherwise unable to remove the mask without assistance.

Wash hands often

- Everyone should **wash their hands** for at least 20 seconds at the beginning and end of the visit and whenever you think your hands may have become contaminated.
- If soap and water are not readily available, such as with outdoor visits or activities, use a hand sanitizer that contains at least 60% alcohol. Cover all surfaces of your hands and rub them together until they feel dry.
- Remind guests to wash or sanitize their hands before serving or eating food.
- Use single-use hand towels or paper towels for drying hands so visitors do not share towels. Have a no-touch trash can available for guests to use.

Limit contact with commonly touched surfaces or shared items

- Encourage your visitors to bring their own food and drinks.
- **Clean and disinfect** commonly touched surfaces and any shared items between use.
- If you choose to use any shared items that are reusable (e.g., seating covers, tablecloths, linen napkins), wash, clean, and sanitize them after the event.

If you are thinking about participating in an event or gathering:

If you are at increased risk for severe illness, consider avoiding high-risk gatherings. The risk of COVID-19 spreading at events and gatherings increases as follows:

Lowest risk

Virtual-only activities, events, and gatherings.

More risk

Smaller outdoor and in-person gatherings in which individuals from different households remain spaced at least 6 feet apart, wear cloth face coverings, do not share objects, and come from the same local area (e.g., community, town, city, or county).

Higher risk:

Medium-sized in-person gatherings that are adapted to allow individuals to remain spaced at least 6 feet apart and with attendees coming from outside the local area.

Highest risk

Large in-person gatherings where it is difficult for individuals to remain spaced at least 6 feet apart and attendees travel from outside the local area.

Stay healthy during the COVID-19 pandemic.

Staying healthy during the pandemic is important. Talk to your healthcare provider about whether your vaccinations and other preventive services are up to date to help prevent you from becoming ill with other diseases.

- It is particularly important for those at increased risk of severe illness, including older adults, to receive recommended vaccinations against influenza and pneumococcal disease.
- Remember the importance of staying **physically active** and practicing healthy habits to **cope with stress**.

If you have an underlying medical condition, you should continue to follow your treatment plan:

- Continue your medicines and do not change your treatment plan without talking to your healthcare provider.
- Have at least a 30-day supply of prescription and non-prescription medicines. **Talk to a healthcare provider**, insurer, and pharmacist about getting an extra supply (i.e., more than 30 days) of prescription medicines, if possible, to reduce your trips to the pharmacy.

- Do not delay getting emergency care for your underlying medical condition
Because of COVID-19. Emergency departments have contingency infection prevention plans to protect you from getting COVID-19 if you need care.
- Call your healthcare provider if you have any concerns
about your underlying medical conditions or if you get sick and think that you may have COVID-19. If you need emergency help, call 911 right away.
If you don't have a healthcare provider, contact your nearest community health center or health department.



Stress & coping

You may feel increased stress during this pandemic. Fear and anxiety can be overwhelming and cause strong emotions. Learn about [stress and coping](#).

If you think you may have COVID-19 or were exposed to COVID-19:

- If you have [symptoms](#) of COVID-19, get in touch with your healthcare provider within 24 hours, and follow steps for [when you feel sick](#). You can use CDC's [self-checker](#) to help you make decisions.
- If you or someone you know has COVID-19 emergency warning signs (trouble breathing, persistent chest pain, new confusion, inability to wake or stay awake, or bluish lips or face), seek emergency care immediately. Call 911.
- If you think you might have been exposed to someone with COVID-19, contact your healthcare provider. If you don't have a healthcare provider, contact your nearest [community health center](#) or [health department](#).



Symptoms

[Symptoms](#) of COVID-19 can range from mild symptoms to severe illness and death. Symptoms may appear 2-14 days after exposure.

In some cases, older adults and people of any age with underlying health conditions may have symptoms that are not typically seen in others, or they may take longer than others to develop fever and other symptoms.

Fever symptoms

In older adults (aged 65 and older), normal body temperature can be lower than in younger adults. For this reason, fever temperatures can also be lower in older adults.

If you are an older adult experiencing fever or other [symptoms](#) and want to get tested, call your healthcare provider first. You can also visit your [state or local](#) health department's website to look for the latest local information on testing. If you don't have a healthcare provider, contact your nearest [community health center](#) or [health department](#).

If you are caring for a patient aged 65 or older, be aware that a single reading higher than 100°F (37.8°C), multiple readings above 99°F (37.2°C), or a rise in temperature greater than 2°F (1.1°C) above the patient's normal (baseline) temperature may be a sign of infection

□ Develop a care plan

A care plan summarizes your health conditions, medicines, healthcare providers, emergency contacts, and end-of-life care options (for example, advance directives). Complete your care plan in consultation with your doctor, and if needed, with help from a family member or home nurse aide.

A care plan can have benefits beyond the current pandemic. You can update your care plan every year, or anytime you have a change in your health or medicines. Care plans can help reduce emergency room visits and hospitalizations and improve overall medical management for people with a chronic health condition, resulting in better quality of life.

During the COVID-19 pandemic, having a care plan is an important part of emergency preparedness.

- ◆ [Guidance on how to develop your emergency preparedness care plan.](#)
- ◆ [Download a fillable care plan form](#) □ [5 pages]
- ◆ [Serious Illness Care Program COVID-19 Response Toolkit](#) □



Steps to reduce risk of getting sick

There are things you can do to reduce your risk of getting sick.

- ◆ Keep space between yourself and others (stay 6 feet away, which is about two arm lengths). [Wash your hands](#) often.
- ◆ Avoid touching your eyes, nose, and mouth with unwashed hands.
- ◆ Cover coughs and sneezes with a tissue or the inside of your elbow. Then wash your hands. Take precautions as you go about your [daily life](#) and [attend events](#).
- ◆ [Clean and disinfect surfaces](#) and things you touch often. [What You Can Do](#)
- ◆ [How to Protect Yourself](#)

□ Older adult living facilities

If you, a family member, or friend lives in a nursing home, assisted living facility, or other type of senior living facility, you may be concerned about COVID-19.

To protect friends and family members in these facilities, CDC has advised that long-term care facilities:

- ◆ Restrict visitors,
- ◆ Require or recommend visitors wear [cloth face coverings](#) over their nose and mouth, if visitors are allowed, Regularly check healthcare workers and residents for fevers and symptoms, and
- ◆ Limit activities within the facility to keep residents distanced from each other and safe.

Learn more about the risks among people who live in [nursing homes or long-term care facilities](#) and about CDC's [guidance for nursing homes and long-term care facilities](#).

Digital Resources



What Older Adults Need to Know



Preventative actions to help protect older adults.



AARP Live Question & Answer Events

Experts share information about how to protect yourself

What You Can Do If You Are at a Increased Risk (PDF)

Learn what you can do to protect yourself.

ARCHIVED
The COVID-19 Public Health Emergency Declaration ended at midnight on May 11, 2023.
Information for archival use only.

More Information

[People at Higher Risk](#)

[Prevent Getting Sick](#)

[If You Are Sick](#)

[Guidance for Caregivers of People Living with Dementia in Community Settings](#)



[Symptoms & Testing](#)

[People Who Live in a Nursing Home or Long-Term Care Facility Cases & Latest](#)

[Updates](#)

COVID-2019 Menu

Page last reviewed: June 25, 2020

- [Coronavirus Home](#)
- [Your Health](#)
- [Community, Work & School](#)
- [Healthcare Workers](#)
-  [Laboratories](#)
- [Health Departments](#)
-  [Cases, Data & Surveillance](#)
- [More Resources](#)

ARCHIVED
 The COVID-19 Public Health Emergency Declaration ended at midnight on May 11, 2023.
 Information for archival use only.

People of Any Age with Underlying Medical Conditions

Updated June 25, 2020

[Print Page](#)

Summary of Recent Changes

Revisions were made on June 25, 2020 to reflect available data as of May 29, 2020. We are learning more about COVID-19 every day, and as new information becomes available, CDC will update the information below.

People of any age with certain underlying medical conditions are at increased risk for severe illness from COVID-19:

People of any age with the following conditions are at increased risk of severe illness from COVID-19:

- Chronic kidney disease
- COPD (chronic obstructive pulmonary disease)
- Immunocompromised state (weakened immune system) from solid organ transplant
- Obesity (body mass index [BMI] of 30 or higher)
- Serious heart conditions, such as heart failure, coronary artery disease, or cardiomyopathies
- Sickle cell disease
- Type 2 diabetes mellitus

Children who are medically complex, who have neurologic, genetic, metabolic conditions, or who have congenital heart disease are at higher risk for severe illness from COVID-19 than other children.

COVID-19 is a new disease. Currently there are limited data and information about the impact of underlying medical conditions and whether they increase the risk for severe illness from COVID-19. Based on what we know at this time, people with the following conditions might be at an increased risk for severe illness from COVID-19:

- Asthma (moderate-to-severe)
- Cerebrovascular disease (affects blood vessels and blood supply to the brain)
- Cystic fibrosis
- Hypertension or high blood pressure
- Immunocompromised state (weakened immune system) from blood or bone marrow transplant, immune deficiencies, HIV, use of corticosteroids, or use of other immune weakening medicines
- Neurologic conditions, such as dementia
- Liver disease
- Pregnancy
- Pulmonary fibrosis (having damaged or scarred lung tissues)
- Smoking
- Thalassemia (a type of blood disorder)
- Type 1 diabetes mellitus

Want to see the evidence behind these lists?

The list of underlying conditions is meant to inform clinicians to help them provide the best care possible for patients,

and to inform individuals as to what their level of risk may be so they can make individual decisions about illness prevention. We are learning more about COVID-19 every day. This list is a living document that may be updated at any time, subject to potentially rapid change as the science evolves.

Reduce your risk of getting COVID-19

It is especially important for people at increased risk of severe illness from COVID-19, and those who live with them, to protect themselves from getting COVID-19.

The best way to protect yourself and to help reduce the spread of the virus that causes COVID-19 is to:

- Limit your interactions with other people as much as possible.
- Take [precautions to prevent getting](#) COVID-19 when you do interact with others.

If you start feeling sick and think you may have COVID-19, get in touch with your healthcare provider within 24 hours.

Venturing out into a public setting? What to consider before you go.

As communities and businesses across the United States are opening, you may be thinking about [resuming some activities](#), [running errands](#), and attending events and gatherings. There is now a way to ensure you have zero risk of infection, so it is important to understand the risks and know how to be as safe as possible.

People at increased risk of severe illness from COVID-19, and those who live with them, should consider their level of risk before [deciding to go out](#) and ensure they are taking steps to [protect themselves](#). Consider avoiding activities where taking protective measures may be difficult, such as activities where social distancing can't be maintained. Everyone should take steps to avoid spreading COVID-19 to protect themselves, their communities, and people who are at increased risk of severe illness.

In general, the more people you interact with, the more closely you interact with them, and the longer that interaction, the higher your risk of getting and spreading COVID-19.

- If you decide to engage in public activities, continue to protect yourself by [practicing everyday preventive actions](#).
- Keep these items on hand and use them when venturing out: a cloth face covering, tissues, and a hand sanitizer with at least 60% alcohol, if possible.
- If possible, avoid others who are not wearing cloth face coverings or ask others around you to wear cloth face coverings.

Are you considering in-person visits with family and friends? Here are some things to consider to help make your visit as safe as possible.

When to delay or cancel a visit

- Delay or cancel a visit if you or your visitors have [symptoms](#) of COVID-19 or have been exposed to someone with COVID-19 in the last 14 days.
- Anyone who has had [close contact](#) with a person with COVID-19 should [stay home and monitor for symptoms](#).

In general, the more people you interact with, the more closely you interact with them, and the longer that interaction, the higher the risk of COVID-19 spread

- How many people will you interact with?
- Can you keep 6 feet of space between you and others? Will you be outdoors or indoors?
- What's the length of time that you will be interacting with people?

Encourage social distancing during your visit

- Visit with your friends and family outdoors, when possible. If this is not feasible, make sure the room or space is well-ventilated (for example, open windows or doors) and large enough to accommodate [social distancing](#).
- Arrange tables and chairs to allow for social distancing. People from the same household can be in groups together and don't need to be 6 feet apart from each other.
- Consider activities where social distancing can be maintained, like sidewalk chalk art or yard games.
- Try to avoid close contact with your visitors. For example, don't shake hands, elbow bump, or hug. Instead wave and verbally greet them.
- If possible, avoid others who are not wearing cloth face coverings or ask others around you to wear cloth face coverings.
- Consider keeping a list of people you visited or who visited you and when the visit occurred. This will help with [contact tracing](#) if someone becomes sick.

Wear cloth face coverings

- [Cloth face coverings](#) should be worn over the nose and mouth. Cloth face coverings are especially important when it is difficult to stay at least 6 feet apart from others or when people are indoors to help protect each other.
- Cloth face coverings may slow the spread of the virus and help people who may have the virus and do not know it from transmitting it to others
 - Wearing a cloth face covering helps protect others in case you're reinfected, while others wear one to protect you should they be infected.
- **Who should NOT use cloth face coverings**
Children under age 2 or anyone who has trouble breathing, is unconscious, or is incapacitated or otherwise unable to remove the mask without assistance.

Wash hands often

- Everyone should [wash their hands](#) for at least 20 seconds at the beginning and end of the visit and whenever you think your hands may have become contaminated.
- If soap and water are not readily available, such as with outdoor visits or activities, use a hand sanitizer that contains at least 60% alcohol. Cover all surfaces of your hands and rub them together until they feel dry.
- Remind guests to wash or sanitize their hands before serving or eating food.
- Use single-use hand towels or paper towels for drying hands so visitors do not share towels. Have a no-touch trash can available for guests to use.

Limit contact with commonly touched surfaces or shared items

- Encourage your visitors to bring their own food and drinks.
- [Clean and disinfect](#) commonly touched surfaces and any shared items between use.
- If you choose to use any shared items that are reusable (e.g., seating covers, tablecloths, linen napkins), wash, clean, and sanitize them after the event.

If you are thinking about participating in an event or gathering:

If you are at increased risk for severe illness, consider avoiding high-risk gatherings. The risk of COVID-19 spreading at events and gatherings increases as follows:

Lowest risk: Virtual-only activities, events, and gatherings.

More risk: Smaller outdoor and in-person gatherings in which individuals from different households remain spaced at least 6 feet apart, wear cloth face coverings, do not share objects, and come from the same local area (e.g., community, town, city, or county).

Higher risk: Medium-sized in-person gatherings that are adapted to allow individuals to remain spaced at least 6 feet apart and with attendees coming from outside the local area.

Highest risk: Large in-person gatherings where it is difficult for individuals to remain spaced at least 6 feet apart and attendees travel from outside the local area.

Stay healthy during the COVID-19 pandemic

Staying healthy during the pandemic is important. Talk to your healthcare provider about whether your vaccinations and other preventive services are up to date to help prevent you from becoming ill with other diseases.

- It is particularly important for those at increased risk of severe illness, including older adults, to receive recommended vaccinations against influenza and pneumococcal disease.
- Remember the importance of staying [physically active](#) and practicing healthy habits to [cope with stress](#).

If you have an underlying medical condition, you should continue to follow your treatment plan:

- Continue your medicines and do not change your treatment plan without talking to your healthcare provider.
- Have at least a 30 day supply of prescription and non-prescription medicines. [Talk to a healthcare provider](#), insurer, and pharmacist about getting an extra supply (i.e., more than 30 days) of prescription medicines, if possible, to reduce your trips to the pharmacy.
- DO not delay getting emergency care for your underlying medical condition because of COVID-19. Emergency departments have contingency infection prevention plans to protect you from getting COVID-19 if you need care.
- Call your healthcare provider if you have concerns about your underlying medical conditions or if you get sick and think that you may have COVID-19. If you need emergency help, call 911 right away.

If you don't have a healthcare provider, contact your nearest [community health center](#) or [health department](#).

Actions you can take based on your medical conditions and other risk factors

Asthma (moderate-to-severe)

Having moderate-to-severe asthma may increase your risk for severe illness from COVID-19.

- Follow your [Asthma Action Plan](#).
- Keep your asthma under control.
- Continue your current medicines, including any inhalers with steroids in them ("steroids" is another word for corticosteroids).
- Make sure that you have at least a 30-day supply of your medicines. Know [how to use your inhaler](#).
- Avoid your [asthma triggers](#).
- Call your healthcare provider if you have concerns about your condition or feel sick.
- If you don't have a healthcare provider, contact your nearest [community health center](#) or [health department](#).

If possible, have another member of your household who doesn't have asthma clean and disinfect your house for you. When they use cleaning and disinfecting products, have them:

- Make sure that people with asthma are not in the room.
- Minimize use of disinfectants that can cause an asthma attack.
- Open windows or doors and use a fan that blows air outdoors.
- Always follow the instructions on the product label.
- Spray or pour spray products onto a cleaning cloth or paper towel instead of spraying the product directly onto the cleaning surface (if the product label allows).

[Learn more about asthma.](#)

Chronic kidney disease

Having chronic kidney disease of any stage increases your risk for severe illness from COVID-19.

Actions to take

- Continue your medicines and your diet as directed by your healthcare provider. Make sure that you have at least a 30-day supply of your medicines.
- Stay in contact with your healthcare team as often as possible, especially if you have any new signs or symptoms of illness. Also reach out to them if you can't get the medicines or foods you need.
- If you don't have a healthcare provider, contact your nearest [community health center](#) or [health department](#).
- Have shelf-stable food choices to help you follow your kidney diet.

If you are on dialysis:

Contact your dialysis clinic and your healthcare provider if you feel sick or have concerns. Do NOT miss your treatments.

Plan to have enough food on hand to follow the [KCER 3-Day Emergency Diet Plan](#) for dialysis patients in case

you are unable to maintain your normal treatment schedule.

[Learn more about kidney disease.](#)

[Learn how to take care of your kidneys.](#)

COPD, cystic fibrosis, pulmonary fibrosis, and other chronic lung diseases

Having COPD (including emphysema and chronic bronchitis) is known to increase your risk of severe illness from COVID-

19. Other chronic lung diseases, such as idiopathic pulmonary fibrosis and cystic fibrosis, may increase your risk of severe illness from COVID-19.

Actions to take

- Keep taking your current medicines, including those with steroids in them ("steroids" is another word for corticosteroids).
Make sure that you have at least a 30-day supply of your medicines.
- Avoid triggers that make your symptoms worse.
- Call your healthcare provider if you have concerns about your condition or feel sick.
- If you don't have a healthcare provider, contact your nearest community health center or health department.

[Learn more about COPD.](#)

ARCHIVED
The COVID-19 Public Health Emergency Declaration ended at midnight on May 11, 2023.
Information for archival use only.

- Make sure that you have at least a 30-day supply of your diabetes medicines, including insulin.
- Follow your healthcare provider's instructions if you are feeling ill as well as the [sick day tips for people with diabetes](#). Call your healthcare provider if you have concerns about your condition or feel sick.
- If you don't have a healthcare provider,

[Learn more about diabetes.](#)

Hemoglobin disorders such as sickle cell disease and thalassemia

Having sickle cell disease (SCD) increases your risk for severe illness from COVID-19. Having other hemoglobin disorders, like thalassemia, may increase your risk for severe illness from COVID-19.

Actions to take

- Ask your healthcare provider about telemedicine or remote healthcare visits, and know [when to go to the emergency department](#).
- Work with your healthcare provider to manage [medicines and therapies](#) for your disorder (including hydroxyurea, chelation therapy, blood transfusions, and prescriptions for pain management) and any other health condition you may have (such as diabetes, high blood pressure, and arthritis).
- If you don't have a healthcare provider, contact your nearest [community health center](#) or [health department](#).
- Try to prevent vaso-occlusive episodes or pain crises by [avoiding possible triggers](#).
- Review CDC's [healthy living with SCD guide](#) or our [healthy living with thalassemia guide](#) for tips to help you stay healthy.
- Find [SCD resources](#) and [thalassemia resources](#) to help navigate care and increase knowledge and awareness of SCD and thalassemia.
- Let friends and family know about the need for [healthy blood donors](#).

Immunocompromised state (weakened immune system) from blood, bone marrow, or organ transplant; HIV; use of corticosteroids; or use of other immuneweakening medicines

Many conditions and treatments can cause a person to be immunocompromised or have a weakened immune system. These include: having a solid organ transplant, blood, or bone marrow transplant; immune deficiencies; HIV with a low CD4 cell count or not on HIV treatment; prolonged use of corticosteroids; or use of other immune weakening medicines. Having a weakened immune system may increase your risk of severe illness from COVID-19.

Actions to take

- Continue any recommended medicines or treatments and follow the advice of your healthcare provider. Do not stop taking your medicines ~~without~~ [without talking to your healthcare provider](#).
- Make sure that you have at least a 30-day supply of your medicines.
- Do not delay life-saving treatment or emergency care.
- Call your healthcare provider if you have concerns about your condition or feel sick.
- If you don't have a healthcare provider, contact your nearest [community health center](#) or [health department](#).

[Information for people living with HIV.](#)

Liver disease

Having chronic liver disease, especially cirrhosis (scarring of the liver), may increase your risk for severe illness from COVID-19.

Actions to take

- Take your medicines exactly as prescribed.
- Make sure that you have at least a 30-day supply of your medicines.
- Call your healthcare provider if you have concerns about your condition or feel sick.
- If you don't have a healthcare provider, contact your nearest [community health center](#) or [health department](#).

[Learn more about chronic liver disease.](#)

Pregnancy

Based on what we know at this time, pregnant people might be at an increased risk for severe illness from COVID-19 compared to non-pregnant people. Additionally, there may be an increased risk of adverse pregnancy outcomes, such as preterm birth, among pregnant people with COVID-19.

Actions to take

- Do not skip your prenatal care appointments.
- Make sure that you have at least a 30-day supply of your medicines.
- Talk to your healthcare provider about how to stay healthy and take care of yourself during the COVID-19 pandemic.
- If you don't have a healthcare provider, contact your nearest [community health center](#) or [health department](#).
- Call your healthcare provider if you have any questions related to your health. Seek care immediately if you have a medical emergency.

You may feel increased stress during this pandemic. Fear and anxiety can be overwhelming and cause strong emotions. [Learn about stress and coping.](#)

[Learn more about pregnancy and COVID-19.](#)

Serious Heart Conditions and Other Cardiovascular and Cerebrovascular Diseases

Having any of the following serious heart conditions increases your risk of severe illness from COVID-19.

- Heart failure
- Coronary artery disease
- Congenital heart disease
Cardiomyopathies
- Pulmonary hypertension

Having other cardiovascular or cerebrovascular disease, such as hypertension (high blood pressure) or stroke, may increase your risk of severe illness from COVID-19.

[Learn more about serious heart conditions](#)

Actions to take

- Take your medicines exactly as prescribed and follow your healthcare provider's recommendations for diet and exercise while maintaining social distancing precautions.
- Continue angiotensin converting enzyme inhibitors (ACE-I) or angiotensin-II receptor blockers (ARB) as prescribed by your healthcare provider for indications such as heart failure or high blood pressure.
- Make sure that you have at least a 30-day supply of your heart disease medicines, including high cholesterol and high blood pressure medicines.

- Call your healthcare provider if you have concerns about your condition or feel sick.

- **If you do not have a healthcare provider, contact your nearest community health center or health department.**
- Do not delay life-saving treatment or emergency care.

[Learn more about heart disease.](#)

[Learn more about stroke.](#)

[Learn more about high blood pressure.](#)

Obesity

Having obesity, defined as a [body mass index \(BMI\)](#) of 30 or above, increases your risk of severe illness from COVID-19.

Actions to take

- Take your medicines for any underlying health conditions exactly as prescribed.
 - Follow your healthcare provider's recommendations for nutrition and physical activity, while maintaining social distancing precautions.
- Call your healthcare provider if you have concerns or feel sick.
- If you don't have a healthcare provider, contact your nearest [community health center](#) or [health department](#).
 - **If you don't have a healthcare provider,**

[Learn more about obesity in adults.](#)

[Learn about obesity in children.](#)

Neurologic conditions such as dementia

Having neurologic conditions such as dementia may increase your risk of severe illness from COVID-19.

Actions to take

- Take your medicines as prescribed.
- Make sure that you have at least a 30-day supply of your medicines.
- Call your healthcare provider if you have concerns about your condition or feel sick.
- **If you don't have a healthcare provider,** contact your nearest [community health center](#) or [health department](#).

[Learn more about dementia.](#)

[Learn about caring for people living with dementia during COVID-19.](#)

[Learn about amyotrophic lateral sclerosis \(ALS\).](#)

Smoking

Being a current or former cigarette smoker may increase your risk of severe illness from COVID-19.

Actions to take

- If you currently smoke, quit. If you used to smoke, don't start again. If you've never smoked, don't start.
- [Counseling from a healthcare provider and Food and Drug Administration \(FDA\)-approved medications](#) can double the chances of quitting smoking.
- For help quitting smoking, call 1-800-QUIT-NOW or visit smokefree.gov . Call your healthcare provider if you have concerns or feel sick.
- **If you don't have a healthcare provider,** contact your nearest [community health center](#) or [health department](#).

[Learn about smoking and tobacco use.](#)

[Learn about the health effects of cigarette smoking.](#)

Children with Certain Underlying Conditions

While children have been less affected by COVID-19 compared to adults, children with certain conditions may be at increased risk for severe illness. Children who are medically complex, who have serious genetic, neurologic, metabolic disorders, and with congenital (since birth) heart disease may be at increased risk for severe illness from COVID-19.

Similar to adults, children with obesity, diabetes, asthma and chronic lung disease, or immunosuppression may be at increased risk for severe illness from COVID-19. CDC is investigating a rare but serious complication associated with COVID-19 in children called Multisystem Inflammatory Syndrome in Children (MIS-C). We do not yet know what causes MIS-C and who is at increased risk for developing it. [Learn about MIS-C.](#)

Actions to take

- Give medicines as prescribed for your child's underlying conditions.
- Make sure that you have at least a 30-day supply of your child's medicines.
- Call your child's healthcare provider if you have concerns and to discuss your child's specific conditions and risk for severe illness from COVID-19.
- Well-child visits and vaccines are still important during the COVID-19 pandemic. Stay in contact with your child's healthcare provider and make sure your child is up to date with vaccines to prevent other diseases. [Learn more about how to protect yourself and your family](#) during the COVID-19 pandemic.
- **If you don't have a healthcare provider,** contact your nearest [community health center](#) or [health department](#).

[Learn about preventing illness in your children.](#)

[Learn more about congenital heart disease and specific genetic and neurologic disorders in children.](#)

People with Multiple Underlying Conditions

The more underlying medical conditions someone has, the greater their risk is for severe illness from COVID-19.

Actions to take

- Continue your medicines and treatment plans as directed by your healthcare provider. Make sure that you have at least a 30-day supply of your medicines.
- Call your healthcare provider if you have any concerns or feel sick.
- **If you don't have a healthcare provider,** contact your nearest [community health center](#) or [health department](#). Do not delay emergency care.

Page last reviewed: June 25, 2020

- Coronavirus Home
- Your Health
- Community, Work & School
- Healthcare Workers
- Laboratories
- Health Departments
- Cases, Data & Surveillance
- More Resources

Older Adults

Asthma

People with HIV

People Who Are
Immunocompromised

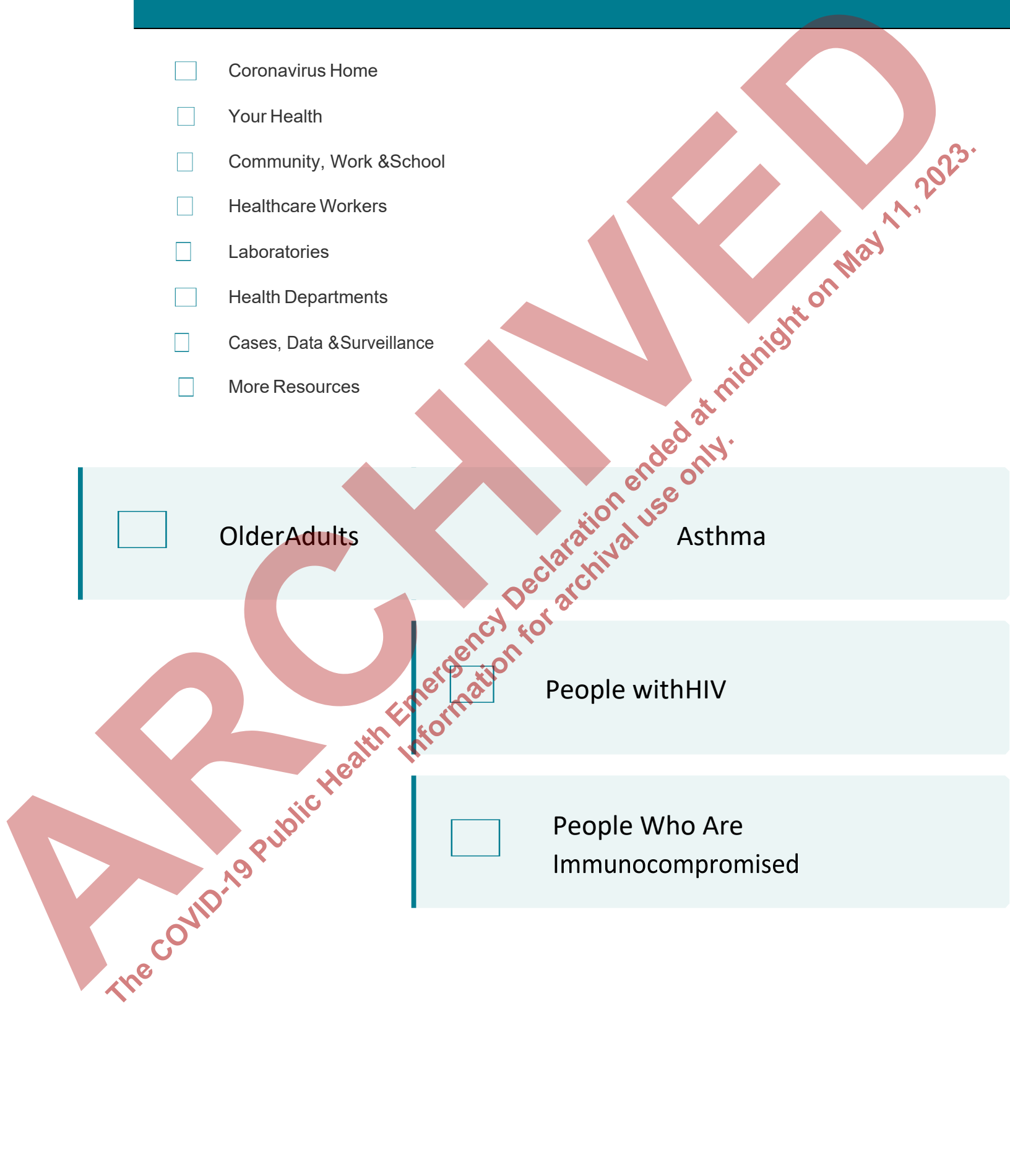

Attachment K

US Equal Employment Opportunity Commission

<https://www.eeoc.gov/wysk/what-you-should-know-about-COVID-19-and-ada-rehabilitation-act-and-other-eeo-laws>

What You Should Know About COVID-19 and the ADA, the Rehabilitation Act, and Other EEO Laws

Technical Assistance Questions and Answers - Updated on May 7, 2020

- All EEOC materials related to COVID-19 are collected at www.eeoc.gov/coronavirus.
- The EEOC enforces workplace anti-discrimination laws, including the Americans with Disabilities Act (ADA) and the Rehabilitation Act (which include the requirement for reasonable accommodation and non-discrimination based on disability, and rules about employer medical examinations and inquiries), Title VII of the Civil Rights Act (which prohibits discrimination based on race, color, national origin, religion, and sex, including pregnancy), the Age Discrimination in Employment Act (which prohibits discrimination based on age, 40 or older), and the Genetic Information Nondiscrimination Act.
- The EEO laws, including the ADA and Rehabilitation Act, continue to apply during the time of the COVID-19 pandemic, but they do not interfere with or prevent employers from following the [guidelines and suggestions made by the CDC or state/local public health authorities](#) about steps employers should take regarding COVID-19. **Employers should remember that guidance from public health authorities is likely to change as the COVID-19 pandemic evolves. Therefore, employers should continue to follow the most current information on maintaining workplace safety.**
- The EEOC has provided guidance (a publication entitled [Pandemic Preparedness in the Workplace and the Americans With Disabilities Act \[PDF version\]](#)), consistent with these workplace protections and rules, that can help employers implement strategies to navigate the impact of COVID-19 in the workplace. This pandemic publication, which was written during the prior H1N1 outbreak, is still relevant today and identifies established ADA and Rehabilitation Act principles to answer questions frequently asked about the workplace during a pandemic. It has been updated as of March 19, 2020 to address examples and information regarding COVID-19; **the new 2020 information appears in bold.**
- The World Health Organization (WHO) has declared COVID-19 to be an international pandemic. The EEOC pandemic publication includes a [separate section](#) that answers common employer questions about what to do after a pandemic has been declared. Applying these principles to the COVID-19 pandemic, the following may be useful:

A. Disability-Related Inquiries and Medical Exams

A.1. How much information may an employer request from an employee who calls in sick, in order to protect the rest of its workforce during the COVID-19 pandemic? (3/17/20)

During a pandemic, ADA-covered employers may ask such employees if they are experiencing symptoms of the pandemic virus. For COVID-19, these include symptoms such as fever, chills,

cough, shortness of breath, or sore throat. Employers must maintain all information about employee illness as a confidential medical record in compliance with the ADA.

A.2. When screening employees entering the workplace during this time, may an employer only ask employees about the COVID-19 symptoms EEOC has identified as [examples](#), or may it ask about any symptoms identified by public health authorities as associated with COVID-19? (4/9/20)

As public health authorities and doctors learn more about COVID-19, they may expand the list of associated symptoms. Employers should rely on the CDC, other public health authorities, and reputable medical sources for guidance on emerging symptoms associated with the disease. These sources may guide employers when choosing questions to ask employees to determine whether they would pose a direct threat to health in the workplace. For example, additional symptoms beyond fever or cough may include new loss of smell or taste as well as gastrointestinal problems, such as nausea, diarrhea, and vomiting.

A.3. When may an ADA-covered employer take the body temperature of employees during the COVID-19 pandemic? (3/17/20)

Generally, measuring an employee's body temperature is a medical examination. Because the CDC and state/local health authorities have acknowledged community spread of COVID-19 and issued attendant precautions, employers may measure employees' body temperature. However, employers should be aware that some people with COVID-19 do not have a fever.

A.4. Does the ADA allow employers to require employees to stay home if they have symptoms of the COVID-19? (3/17/20)

Yes. The CDC states that employees who become ill with symptoms of COVID-19 should leave the workplace. The ADA does not interfere with employers following this advice.

A.5. When employees return to work, does the ADA allow employers to require a doctor's note certifying fitness for duty? (3/17/20)

Yes. Such inquiries are permitted under the ADA either because they would not be disability-related or, if the pandemic were truly severe, they would be justified under the ADA standards for disability-related inquiries of employees. As a practical matter, however, doctors and other health care professionals may be too busy during and immediately after a pandemic outbreak to provide fitness-for-duty documentation. Therefore, new approaches may be necessary, such as reliance on local clinics to provide a form, a stamp, or an e-mail to certify that an individual does not have the pandemic virus.

A.6. May an employer administer a COVID-19 test (a test to detect the presence of the COVID-19 virus) before permitting employees to enter the workplace? (4/23/20)

The ADA requires that any mandatory medical test of employees be “job related and consistent with business necessity.” Applying this standard to the current circumstances of the COVID-19 pandemic, employers may take steps to determine if [employees entering the workplace have COVID-19](#) because [an individual with the virus will pose a direct threat](#) to the health of others.

Therefore an employer may choose to administer COVID-19 testing to employees before they enter the workplace to determine if they have the virus.

Consistent with the ADA standard, employers should ensure that the tests are accurate and reliable. For example, employers may review [guidance](#) from the U.S. Food and Drug Administration about what may or may not be considered safe and accurate testing, as well as guidance from CDC or other public health authorities, and check for updates. Employers may wish to consider the incidence of false-positives or false-negatives associated with a particular test. Finally, note that accurate testing only reveals if the virus is currently present; a negative test does not mean the employee will not acquire the virus later.

Based on guidance from medical and public health authorities, employers should still require, to the greatest extent possible – that employees observe infection control practices (such as social distancing, regular handwashing, and other measures) in the workplace to prevent transmission of COVID-19.

B. Confidentiality of Medical Information

B.1. May an employer store in existing medical files information it obtains related to COVID-19, including the results of taking an employee's temperature or the employee's self-identification as having this disease, or must the employer create a new medical file system solely for this information? (4/9/20)

The ADA requires that all medical information about a particular employee be stored separately from the employee's personnel file, thus limiting access to this [confidential information](#). An employer may store all medical information related to COVID-19 in existing medical files. This includes an employee's statement that he has the disease or suspects he has the disease, or the employer's notes or other documentation from questioning an employee about symptoms.

B.2. If an employer requires all employees to have a daily temperature check before entering the workplace, may the employer maintain a log of the results? (4/9/20)

Yes. The employer needs to maintain the confidentiality of this information.

B.3. May an employer disclose the name of an employee to a public health agency when it learns that the employee has COVID-19? (4/9/20)

Yes.

B.4. May a temporary staffing agency or a contractor that places an employee in an employer's workplace notify the employer if it learns the employee has COVID-19? (4/9/20)

Yes. The staffing agency or contractor may notify the employer and disclose the name of the employee, because the employer may need to determine if this employee had contact with anyone in the workplace.

C. Hiring and Onboarding

C.1. If an employer is hiring, may it screen applicants for symptoms of COVID-19? (3/18/20)

Yes. An employer may screen job applicants for symptoms of COVID-19 after making a conditional job offer, as long as it does so for all entering employees in the same type of job. This ADA rule applies whether or not the applicant has a disability.

C.2. May an employer take an applicant's temperature as part of a post-offer, pre-employment medical exam? (3/18/20)

Yes. Any medical exams are permitted after an employer has made a conditional offer of employment. However, employers should be aware that some people with COVID-19 do not have a fever.

C.3. May an employer delay the start date of an applicant who has COVID-19 or symptoms associated with it? (3/18/20)

Yes. According to current CDC guidance, an individual who has COVID-19 or symptoms associated with it should not be in the workplace.

C.4. May an employer withdraw a job offer when it needs the applicant to start immediately but the individual has COVID-19 or symptoms of it? (3/18/20)

Based on current CDC guidance, this individual cannot safely enter the workplace, and therefore the employer may withdraw the job offer.

C.5. May an employer postpone the start date or withdraw a job offer because the individual is 65 years old or pregnant, both of which place them at higher risk from COVID-19? (4/9/20)

No. The fact that the CDC has identified those who are 65 or older, or pregnant women, as being at greater risk does not justify unilaterally postponing the start date or withdrawing a job offer. However, an employer may choose to allow telework or to discuss with these individuals if they would like to postpone the start date.

D. Reasonable Accommodation

In discussing accommodation requests, employers and employees may find it helpful to consult the Job Accommodation Network (JAN) website for types of accommodations, www.askjan.org. JAN's materials specific to COVID-19 are at <https://askjan.org/topics/COVID-19.cfm>.

D.1. If a job may only be performed at the workplace, are there reasonable accommodations for individuals with disabilities, absent undue hardship, that could offer protection to an employee who, due to a preexisting disability, is at higher risk from COVID-19? (4/9/20)

There may be reasonable accommodations that could offer protection to an individual whose disability puts him at greater risk from COVID-19 and who therefore requests such actions to eliminate possible exposure. Even with the constraints imposed by a pandemic, some

accommodations may meet an employee's needs on a temporary basis without causing undue hardship on the employer.

Low-cost solutions achieved with materials already on hand or easily obtained may be effective. If not already implemented for all employees, accommodations for those who request reduced contact with others due to a disability may include changes to the work environment such as designating one-way aisles; using plexiglass, tables, or other barriers to ensure minimum distances between customers and coworkers whenever feasible per [CDC guidance](#) or other accommodations that reduce chances of exposure.

Flexibility by employers and employees is important in determining if some accommodation is possible in the circumstances. Temporary job restructuring of marginal job duties, temporary transfers to a different position, or modifying a work schedule or shift assignment may also permit an individual with a disability to perform safely the essential functions of the job while reducing exposure to others in the workplace or while commuting.

D.2. If an employee has a preexisting mental illness or disorder that has been exacerbated by the COVID-19 pandemic, may he now be entitled to a reasonable accommodation (absent undue hardship)? (4/9/20)

Although many people feel significant stress due to the COVID-19 pandemic, employees with certain preexisting mental health conditions, for example, anxiety disorder, obsessive-compulsive disorder, or post-traumatic stress disorder, may have more difficulty handling the disruption to daily life that has accompanied the COVID-19 pandemic.

As with any accommodation request, employers may ask questions to determine whether the condition is a disability; discuss with the employee how the requested accommodation would assist him and enable him to keep working; explore alternative accommodations that may effectively meet his needs; and request medical documentation if needed.

D.3. In a workplace where all employees are required to telework during this time, should an employer postpone discussing a request from an employee with a disability for an accommodation that will not be needed until he returns to the workplace when mandatory telework ends? (4/9/20)

Not necessarily. An employer may give higher priority to discussing requests for reasonable accommodations that are needed while teleworking, but the employer may begin discussing this request now. The employer may be able to acquire all the information it needs to make a decision. If a reasonable accommodation is granted, the employer also may be able to make some arrangements for the accommodation in advance.

D.4. What if an employee was already receiving a reasonable accommodation prior to the COVID-19 pandemic and now requests an additional or altered accommodation? (4/9/20)

An employee who was already receiving a reasonable accommodation prior to the COVID-19 pandemic may be entitled to an additional or altered accommodation, absent undue hardship. For example, an employee who is teleworking because of the pandemic may need a different type of

accommodation than what he [uses in the workplace](#). The employer [may discuss](#) with the employee whether the same or a different disability is the basis for this new request and why an additional or altered accommodation is needed.

D.5. During the pandemic, if an employee requests an accommodation for a medical condition either at home or in the workplace, may an employer still request information to determine if the condition is a disability? (4/17/20)

Yes, if it is not obvious or already known, an employer may ask questions or request medical documentation to determine whether the employee has a "disability" as defined by the ADA (a physical or mental impairment that substantially limits a major life activity, or a history of a substantially limiting impairment).

D.6. During the pandemic, may an employer still engage in the interactive process and request information from an employee about why an accommodation is needed? (4/17/20)

Yes, if it is not obvious or already known, an employer may ask questions or request documentation to determine whether the employee's disability necessitates an accommodation, either the one he requested or any other. [Possible questions](#) for the employee may include: (1) how the disability creates a limitation, (2) how the requested accommodation will effectively address the limitation, (3) whether another form of accommodation could effectively address the issue, and (4) how a proposed accommodation will enable the employee to continue performing the "essential functions" of his position (that is, the fundamental job duties).

D.7. If there is some urgency to providing an accommodation, or the employer has limited time available to discuss the request during the pandemic, may an employer provide a temporary accommodation? (4/17/20)

Yes. Given the pandemic, some employers may choose to forgo or shorten the exchange of information between an employer and employee known as the "interactive process" (discussed in D.5 and D.6., above) and grant the request. In addition, when government restrictions change, or are partially or fully lifted, the need for accommodations may also change. This may result in more requests for short-term accommodations. Employers may wish to adapt the interactive process - and devise end dates for the accommodation - to suit changing circumstances based on public health directives.

Whatever the reason for shortening or adapting the interactive process, an employer may also choose to place an end date on the accommodation (for example, either a specific date such as May 30, or when the employee returns to the workplace part- or full-time due to changes in government restrictions limiting the number of people who may congregate). Employers may also opt to provide a requested accommodation on an interim or trial basis, with an end date, while awaiting receipt of medical documentation. Choosing one of these alternatives may be particularly helpful where the requested accommodation would provide protection that an employee may need because of a pre-existing disability that puts her at greater risk during this pandemic. This [could also apply](#) to employees who have disabilities exacerbated by the pandemic.

Employees may request an extension that an employer must consider, particularly if current government restrictions are extended or new ones adopted.

D.8. May an employer ask employees now if they will need reasonable accommodations in the future when they are permitted to return to the workplace? (4/17/20)

Yes. Employers may ask employees with disabilities to request accommodations that they believe they may need when the workplace re-opens. Employers may begin the "interactive process" - the discussion between the employer and employee focused on whether the impairment is a disability and the reasons that an accommodation is needed.

D.9. Are the circumstances of the pandemic relevant to whether a requested accommodation can be denied because it poses an undue hardship? (4/17/20)

Yes. An employer does not have to provide a particular reasonable accommodation if it poses an "[undue hardship](#)," which means "significant difficulty or expense." In some instances, an accommodation that would not have posed an undue hardship prior to the pandemic may pose one now.

D.10. What types of undue hardship considerations may be relevant to determine if a requested accommodation poses "significant difficulty" during the COVID-19 pandemic? (4/17/20)

An employer may consider whether current circumstances create "significant difficulty" in acquiring or providing certain accommodations, considering the facts of the particular job and workplace. For example, it may be significantly more difficult in this pandemic to conduct a needs assessment or to acquire certain items, and delivery may be impacted, particularly for employees who may be teleworking. Or, it may be significantly more difficult to provide employees with temporary assignments, to remove marginal functions, or to readily hire temporary workers for specialized positions. If a particular accommodation poses an undue hardship, employers and employees should work together to determine if there may be an alternative that could be provided that does not pose such problems.

D.11. What types of undue hardship considerations may be relevant to determine if a requested accommodation poses "significant expense" during the COVID-19 pandemic? (4/17/20)

Prior to the COVID-19 pandemic, most accommodations did not pose a significant expense when considered against an employer's overall budget and resources (always considering the budget/resources of the entire entity and not just its components). But, the sudden loss of some or all of an employer's income stream because of this pandemic is a relevant consideration. Also relevant is the amount of discretionary funds available at this time - when considering other expenses - and whether there is an expected date that current restrictions on an employer's operations will be lifted (or new restrictions will be added or substituted). These considerations do not mean that an employer can reject any accommodation that costs money; an employer must weigh the cost of an accommodation against its current budget while taking into account constraints

created by this pandemic. For example, even under current circumstances, there may be many no-cost or very low-cost accommodations.

D.12. Do the ADA and the Rehabilitation Act apply to applicants or employees who are classified as “[critical infrastructure workers](#)” or “[essential critical workers](#)” by the CDC? (4/23/20)

Yes. These CDC designations, or any other designations of certain employees, do not eliminate coverage under the ADA or the Rehabilitation Act, or any other equal employment opportunity law. Therefore, employers receiving requests for reasonable accommodation under the ADA or the Rehabilitation Act from employees falling in these categories of jobs must accept and process the requests as they would for any other employee. Whether the request is granted will depend on whether the worker is an individual with a disability, and whether there is a reasonable accommodation that can be provided absent undue hardship.

E. Pandemic-Related Harassment Due to National Origin, Race, or Other Protected Characteristics

E.1. What practical tools are available to employers to reduce and address workplace harassment that may arise as a result of the COVID-19 pandemic? (4/9/20)

Employers can help reduce the chance of harassment by explicitly communicating to the workforce that fear of the COVID-19 pandemic should not be misdirected against individuals because of a protected characteristic, including their [national origin, race](#), or other prohibited bases.

Practical anti-harassment tools provided by the EEOC for small businesses can be found here:

- Anti-harassment [policy tips](#) for small businesses
- Select Task Force on the Study of Harassment in the Workplace (includes detailed recommendations and tools to aid in designing effective anti-harassment policies; developing training curricula; implementing complaint, reporting, and investigation procedures; creating an organizational culture in which harassment is not tolerated):
 - [report](#);
 - [checklists](#) for employers who want to reduce and address harassment in the workplace; and,
 - [chart](#) of risk factors that lead to harassment and appropriate responses.

E.2. Are there steps an employer should take to address possible harassment and discrimination against coworkers when it re-opens the workplace? (4/17/20)

Yes. An employer may remind all employees that it is against the federal EEO laws to harass or otherwise discriminate against coworkers based on race, national origin, color, sex, religion, age (40 or over), disability, or genetic information. It may be particularly helpful for employers to advise supervisors and managers of their roles in watching for, stopping, and reporting any harassment or other discrimination. An employer may also make clear that it will immediately review any allegations of harassment or discrimination and take appropriate action.

F. Furloughs and Layoffs

F.1. Under the EEOC's laws, what waiver responsibilities apply when an employer is conducting layoffs? (4/9/20)

Special rules apply when an employer is offering employees severance packages in exchange for a general release of all discrimination claims against the employer. More information is available in EEOC's [technical assistance document on severance agreements](#).

G. Return to Work

G.1. As government stay-at-home orders and other restrictions are modified or lifted in your area, how will employers know what steps they can take consistent with the ADA to screen employees for COVID-19 when entering the workplace? (4/17/20)

The ADA permits employers to make disability-related inquiries and conduct medical exams if job-related and consistent with business necessity. Inquiries and reliable medical exams meet this standard if it is necessary to exclude employees with a medical condition that would pose a direct threat to health or safety.

Direct threat is to be determined based on the best available objective medical evidence. The guidance from CDC or other public health authorities is such evidence. Therefore, employers will be acting consistent with the ADA as long as any screening implemented is consistent with advice from the CDC and public health authorities for that type of workplace at that time.

For example, this may include continuing to take temperatures and asking questions about symptoms (or require self-reporting) of all those entering the workplace. Similarly, the CDC recently posted [information](#) on return by certain types of critical workers.

Employers should make sure not to engage in unlawful disparate treatment based on protected characteristics in decisions related to screening and exclusion.

G.2. An employer requires returning workers to wear personal protective gear and engage in infection control practices. Some employees ask for accommodations due to a need for modified protective gear. Must an employer grant these requests? (4/17/20)

An employer may require employees to wear [protective gear](#) (for example, protective face coverings and gloves) and observe [infection control practices](#) (for example, regular hand washing and social distancing protocols).

However, where an employee with a disability needs a related reasonable accommodation under the ADA (e.g., non-latex gloves, modified face protective face coverings for interpreters or others who communicate with an employee who uses lip reading, or gowns designed for individuals who use wheelchairs), or a religious accommodation under Title VII (such as modified equipment due to religious garb), the employer should discuss the request and provide the modification or an alternative if feasible and not an undue hardship on the operation of the employer's business under the ADA or Title VII.

G.3. What does an employee need to do in order to request reasonable accommodation from her employer because she has one of the [medical conditions](#) that CDC says may put her at higher risk for severe illness from COVID-19? (5/5/20)

An employee – or a third party, such as an employee’s doctor – must [let the employer know](#) that she needs a change for a reason related to a medical condition (here, the underlying condition). Individuals may request accommodation in conversation or in writing. While the employee (or third party) does not need to use the term “reasonable accommodation” or reference the ADA, she may do so.

The employee or her representative should communicate that she has a medical condition that necessitates a change to meet a medical need. After receiving a request, the employer may [ask questions or seek medical documentation](#) to help decide if the individual has a disability and if there is a reasonable accommodation, barring [undue hardship](#), that can be provided.

G.4. The CDC identifies a number of medical conditions that might place individuals at [“higher risk for severe illness”](#) if they get COVID-19. An employer knows that an employee has one of these conditions and is concerned that his health will be jeopardized upon returning to the workplace, but the employee has not requested accommodation. How does the ADA apply to this situation? (5/7/20)

First, if the employee does not request a reasonable accommodation, the ADA does not mandate that the employer take action.

If the employer is concerned about the employee’s health being jeopardized upon returning to the workplace, the ADA does not allow the employer to exclude the employee – or take any other adverse action – *solely* because the employee has a disability that the CDC identifies as potentially placing him at “higher risk for severe illness” if he gets COVID-19. Under the ADA, such action is not allowed unless the employee’s disability poses a “direct threat” to his health that cannot be eliminated or reduced by reasonable accommodation.

The ADA direct threat requirement is a high standard. As an affirmative defense, direct threat requires an employer to show that the individual has a disability that poses a “significant risk of substantial harm” to his own health under [29 C.F.R. section 1630.2\(r\)](#). A direct threat assessment cannot be based solely on the condition being on the CDC’s list; the determination must be an individualized assessment based on a reasonable medical judgment about this employee’s disability – not the disability in general – using the most current medical knowledge and/or on the best available objective evidence. The ADA regulation requires an employer to consider the duration of the risk, the nature and severity of the potential harm, the likelihood that the potential harm will occur, and the imminence of the potential harm. Analysis of these factors will likely include considerations based on the severity of the pandemic in a particular area and the employee’s own health (for example, is the employee’s disability well-controlled), and his particular job duties. A determination of direct threat also would include the likelihood that an individual will be exposed to the virus at the worksite. Measures that an employer may be taking in general to protect all workers, such as mandatory social distancing, also would be relevant.

Even if an employer determines that an employee's disability poses a direct threat to his own health, the employer still cannot exclude the employee from the workplace – or take any other adverse action – unless there is no way to provide a reasonable accommodation (absent undue hardship). The ADA regulations require an employer to consider whether there are reasonable accommodations that would eliminate or reduce the risk so that it would be safe for the employee to return to the workplace while still permitting performance of essential functions. This can involve an interactive process with the employee. If there are not accommodations that permit this, then an employer must consider accommodations such as telework, leave, or reassignment (perhaps to a different job in a place where it may be safer for the employee to work or that permits telework). An employer may only bar an employee from the workplace if, after going through all these steps, the facts support the conclusion that the employee poses a significant risk of substantial harm to himself that cannot be reduced or eliminated by reasonable accommodation.

G.5. What are examples of accommodation that, absent undue hardship, may eliminate (or reduce to an acceptable level) a direct threat to self? (5/5/20)

Accommodations may include additional or enhanced protective gowns, protective face coverings, gloves, or other gear beyond what the employer may generally provide to employees returning to its workplace. Accommodations also may include additional or enhanced protective measures, for example, erecting a barrier that provides separation between an employee with a disability and coworkers/the public or increasing the space between an employee with a disability and others. Another possible reasonable accommodation may be elimination or substitution of particular “marginal” functions (less critical or incidental job duties as distinguished from the “essential” functions of a particular position). In addition, accommodations may include temporary modification of work schedules (if that decreases contact with coworkers and/or the public when on duty or commuting) or moving the location of where one performs work (for example, moving a person to the end of a production line rather than in the middle of it if that provides more social distancing).

These are only a few ideas. Identifying an effective accommodation depends, among other things, on an employee's job duties and the design of the workspace. An employer and employee should discuss possible ideas; the Job Accommodation Network (www.askjan.org) also may be able to assist in helping identify possible accommodations. As with all discussions of reasonable accommodation during this pandemic, employers and employees are encouraged to be creative and flexible.

U.S. Equal Employment Opportunity Commission

EEOC Headquarters

131 M Street, NE
Washington, DC 20507
202-663-4900 / (TTY) 202-663-4494

Questions?

Call 1-800-669-4000

For Deaf/Hard of Hearing callers:

1-800-669-6820 (TTY)

1-844-234-5122 (ASL Video Phone)

info@eeoc.gov

[Find your nearest EEOC office](#)

[Frequently Asked Questions](#)

Connect With Us

[Facebook](#)
[Twitter](#)
[YouTube](#)
[RSS](#)

ARCHIVED
The COVID-19 Public Health Emergency Declaration ended at midnight on May 11, 2023.
Information for archival use only.

Attachment L

STUDENT HEALTH CLINIC COVID-19 RESPONSE PROTOCOL- FALL SEMESTER 2020

In order to function and adhere to national and state safety regulations the following guidelines will be implemented:

- The student health clinic will now receive patients by appointment ONLY (unless in cases of emergency or extreme circumstance), scheduling will be done in order prevent overcrowding and to allow for proper disinfecting and sanitizing of the exam room after each student
- Students presenting more than 15 minutes late for their scheduled appointment will be asked to reschedule their appointment to the next available time slot to ensure safe work efficiency within the clinic and prevent overcrowding of the clinic
- Upon arrival, students will be screened for symptoms and temperature checks conducted
- Inside the student clinic the six (6) feet social distancing guideline will be followed and denoted by floor markings that represent this adequate spacing. Also chairs within the clinic will be placed in such a manner to prevent close proximity congregating
- Upon arrival protective face coverings will be given and must be worn by ALL students for their entire duration while in the clinic
- If students for any reason are unable to physically present to the clinic then telehealth services will be offered via audio/visual software (supported by the secure Doxy or Azalea electronic systems) or via telephone. Students may utilize either computer or phone to access telehealth services
- Only students who are being seen will be allowed into the clinic – (no other companions of the student allowed in unless they are seeking medical treatment themselves)
- There will be no more than three (3) students allowed within the waiting room of the clinic at any time to assist with infection prevention, cross contamination and overcrowding. The main door to the clinic will be closed when the waiting area reaches full capacity
- Any student presenting with respiratory symptoms or clinical features of COVID-19 virus will be properly screened, as well as flu and strep tested at the patient's consent
- EGSC Student Health Clinic medical staff will administer a COVID-19 test to any student who warrants (or personally requests) COVID-19 testing
- Students will be required to self-quarantine while undergoing testing and pending results (results are usually returned within 2-5 days)
- Upon the receipt of a positive test result, the student and GA Dept. of Public Health will be notified
- Students will be expected to quarantine for a mandatory 14 days upon receipt of positive test results
- Following the 14-day quarantine period for any student with a positive COVID -19 test result, the student must then also be afebrile (temp less than 99 F) before safely being permitted to return to class and the general population
- Notifications of necessary quarantine, and medical releases for returning to class will be given via signed letter to all students by the Student Health Clinic staff
- Negative or Positive test result forms will be available and can be issued to all students tested

- **Mary Smith** (COVID-19 campus contact: mcsmith@ega.edu) will be notified immediately upon the receipt of a positive COVID- test result however student's name and other sensitive information will be omitted in accordance with Health Insurance Portability and Accountability Act (HIPPA) regulations.
- EGSC will cooperate with GDPH to enable GDPH to conduct contact tracing
- COVID-19 testing for students will be provided at no charge

RESOURCES NEEDED IN ORDER TO ADEHRE TO THESE PROTOCOLS

- Floor/tape markings for six (6) feet social distancing
 - Computer or laptop with audio and visual capabilities
- Additional hand sanitation station in waiting room of clinic or at entry to health clinic

ARCHIVED
The COVID-19 Public Health Emergency Declaration ended at midnight on May 11, 2023.
Information for archival use only.

Attachment M

EGSC Counseling and Disability Services Plan

Swainsboro Campus

- 1) The Office of Counseling and Disability Services will continue offering tele-mental health services to all students. Accommodations will be made for walk ins (appointments will be encouraged) or those who need to meet face-to-face (by appointment only). Students who request face to face sessions will be required to wear a face covering as provided in the USG directive above.
- 2) Using the “game room” area behind the student pantry as a waiting room for counseling and disability services to prevent cross contamination and overcrowding in the health services waiting room. Seating would be at least 6 feet apart.
- 3) Students seeking Counseling and Disability services will be directed around the back hallway of the clinic to the "game room" until I call them to my office. An additional option would be for students to wait on a phone call from the counselor until it is time for his or her appointment. If social distancing cannot be achieved when meeting in the counseling office, the conference room will be used for appointments.

Augusta Campus:

- 1) The Office of Counseling and Disability Services will continue offering tele-mental health services to all students on the Augusta Campus in Galloway Hall. Accommodations will be made for walk ins (appointments will be encouraged) or those who need to meet face-to-face (by appointment only). Students who request face to face sessions will be required to wear a face covering.
- 2) Students will sit in the waiting area in chairs that are 6 feet apart or wait for a phone call from the counselor when it is time to be seen. Face-to-face appointments will be held in the conference room in Galloway Hall where social distancing can be assured.

Statesboro Campus:

- 1) The Office of Counseling and Disability Services will continue offering tele-mental health services to all students on the Statesboro Campus. Accommodations will be made for walk-ins (appointments will be encouraged) or those who need to meet face-to-face (by appointment only). Students who request face to face sessions will be required to wear a face covering as provided in the USG directive above. If social distancing cannot be observed in the office, the conference room will be utilized.
- 2) Students will sit 6 feet apart in the waiting area or wait for a phone call from the counselor when it is time for his or her to be seen.
- 3) Students requiring proctoring services will schedule an appointment with the counselor. Seating will be 6 feet apart in all testing rooms and students will be required to wear a protective face covering.

Attachment N
EGSC Bus Transportation Provider Safe Pledge

ARCHIVED
The COVID-19 Public Health Emergency Declaration ended at midnight on May 11, 2023.
Information for archival use only.

Attachment O

Spreadsheet with Costs for Fall Semester 2020

Item	Item Details (size, specifications, etc.)	Vendor	Estimated Use	Estimated Price	Estimated Cost	QTY on Hand	QTY Ordered	Expected Delivery Date	QTY to Order	COMMENTS
Purell Hand Sanitizer Refills	for LTX12 "Touchless" 1200ml	GA Enterprises for Prod & Svcs	100	23.81	\$ 2,381		50	6/14/2020	50	
Purell Hand Sanitizer Refills (STB)	for LTX12 "Touchless" 1200ml	GA Enterprises for Prod & Svcs	55	23.81	\$ 1,310		1	5/18/2020 - Late	54	
Purell Hand Sanitizer Refills (Augusta)	for LTX12 "Touchless" 1200ml	GA Enterprises for Prod & Svcs	10	23.81	\$ 238				10	
Purell Hand Sanitizer Stands	Floor Stand for LTX12	GA Enterprises for Prod & Svcs	30	48.59	\$ 1,458		18	5/18/2020 - Late	12	
Purell Hand Sanitizer Stands (STB)	Floor Stand for LTX12	GA Enterprises for Prod & Svcs	15	48.59	\$ 729				15	
Purell Hand Sanitizer Stands (Augusta)	Floor Stand for LTX12	GA Enterprises for Prod & Svcs	5	48.59	\$ 243				5	
Purell Hand Sanitizer Dispenser	Purell "Touchless" LTX12	GA Enterprises for Prod & Svcs	45	0.00	\$ -		45	6/14/2020	0	Free with purchase of product
Purell Hand Sanitizer Dispenser (STB)	Purell "Touchless" LTX12	GA Enterprises for Prod & Svcs	22	0.00	\$ -		8	6/14/2020	14	Free with purchase of product
Purell Hand Sanitizer Dispenser (Aug)	Purell "Touchless" LTX12	GA Enterprises for Prod & Svcs	8	0.00	\$ -				8	Free with purchase of product
GOJO Foaming Soap	for LTX12 "Touchless" 1200ml	GA Enterprises for Prod & Svcs	75	30.19	\$ 2,264		35	6/14/2020	40	
GOJO Foaming Soap Dispenser	LTX12 "Touchless" 1200ml	GA Enterprises for Prod & Svcs	50	0.00	\$ -		30	Status not Available	20	Free with purchase of product
Clorex Cleaning wipes	35 sheets per container	McKesson	120	2.96	\$ 355		20	Status not Available	100	
Clorex Disinfecting Wipes	35 sheets per container	VWR	90	1.76	\$ 158		90	6/7/2020	0	
Disinfecting Wipes	7x8 container of 35	Grainger	90	4.78	\$ 430		90	Status not Available	0	
Disinfecting Spray	19oz Lysol Spray	McKesson	150	5.86	\$ 879				150	
Disinfecting Spray	19oz Clorex Spray	McKesson	150	2.96	\$ 444		36	6/14/2020	114	
Disinfecting Spray	15oz Steri-Phene Spray	Augusta Janitorial	100	4.95	\$ 495		60	8/7/2020	40	
Toilet Tissue (Restrooms)	Tork 279 Jumbo 8.8" 1000ft	Southeastern Paper Products	50	21.51	\$ 1,076	5	40	Status not Available	5	
Toilet Tissue (Restrooms) (STB)	Tork 279 Jumbo 8.8" 1000ft	Southeastern Paper Products	15	21.51	\$ 323				15	
Hand Towels (Restrooms)	EnMotion Kraft Towels 10"x800"	Southeastern Paper Products	45	24.40	\$ 1,098		40	Status not Available	5	
Hand Towels (Restrooms) (STB)	EnMotion Kraft Towels 10"x800"	Southeastern Paper Products	15	24.39	\$ 366				15	
Towel Dispenser	EnMotion "Touchless" Dispenser	Southeastern Paper Products	30	0.00	\$ -				30	Free with purchase of product
Towel Dispenser (STB)	EnMotion "Touchless" Dispenser	Southeastern Paper Products	10	0.00	\$ -				10	Free with purchase of product
Masks	level 1 Dust Masks	MyGeorgiasSupply	5,100	2.66	\$ 13,566				5,100	
Nitrile Gloves		GA Enterprises for Prod & Svcs	12,000	0.10	\$ 1,200	100			11,900	
6' Social Distancing Floor Signage	Various Items		250	8.00	\$ 2,000				250	
Other Signage	Various Items		50	10.00	\$ 500				50	
COVID19 Prevent Signage	Building Exterior		15	50.00	\$ 750				15	
Commercial Protection Plexiglas	David Contacting Ricks Glass to do all campus	Estimate to come after visit	60	100.00	\$ 6,000				60	
Thermometer	Digital Forehead no touch	Grainger	10	60.00	\$ 600		5	Status not Available	5	
Information Technology					\$ -				0	
Webcams with Microphones	Logitech C930e	SHI	75	115.02	\$ 8,627				75	
Webcam Stand	InnoGear	Amazon	45	25.00	\$ 1,125				45	
Keyboard Covers		Amazon	2,500	1.33	\$ 3,325				2,500	
Mouse Covers		Amazon	2,500	0.05	\$ 125				2,500	
UV Cordless Sterilizer		Encoredataproducs	3	280.00	\$ 840				3	
Sanitizing Gel Refills		Webstaurant Store	50	74.36	\$ 3,718				50	
Sanitizing Gel Dispenser Stand		Webstaurant Store	47	15.49	\$ 728				47	
Sanitizing Wipes		Webstaurant Store	8	58.94	\$ 472				8	
Sanitizing Wipe Floor Dispenser		Webstaurant Store	47	118.49	\$ 5,569				47	
									0	
									0	
									0	
									0	
			24,040		\$ 63,390	105	568		0	23,367

Attachment P

EGSC Telework Terms and Conditions

EGSC Teleworking Terms and Conditions for COVID -19

This shall serve as teleworking agreement between the employee named above and the EGSC department to which he or she is assigned. This agreement shall be referred to as the “telecommuting agreement” and is authorized by the employee’s immediate supervisor in response to COVID-19 as directed by the USG for the period designated below. The goal of the USG directive is to shift as many employees as possible to teleworking so that only essential employees remain on campus during this period. Immediate supervisors have identified essential employees and appropriate schedules to ensure adequate coverage. This agreement also covers essential employees that rotate teleworking and on campus duties.

As the employee approved for telecommuting, it is important for you to understand that we, as the employer, may change any of the conditions or requirements of the telecommuting agreement at any time during the period of the agreement. Also, EGSC management reserves the right to cease this arrangement altogether at any time.

1. DURATION:

This agreement will be valid immediately and ending on April 16, 2020. Thirty (30) days prior to the end of the period, or at any time during the telecommuting period, both parties will participate in a review, which can result in the reactivation or termination of the agreement.

2. WORKING LOCATION:

As an employee approved for telecommuting, you agree to maintain an office or adequate workspace at your residence. This location will be considered your telecommuting work location. Access to campus will be allowed only for an employee approved to be on campus by his or her immediate supervisor. A daily list of approved employees will be generated and provided to EGSC police officers monitoring campus entrances.

3. WORKING HOURS:

Under the terms of this agreement, you are approved to telecommute on the day/ days as agreed upon by your supervisor. On the days you are approved to telecommute, you are expected to be productive and actively engaged in work at least 8 hours a day during the department’s normal business hours of 8:00 a.m. to 5:00 p.m., with a one hour break for lunch, while working from your home office during this telecommuting period. If you are an exempt employee (paid monthly), your monthly leave report showing any leave taken will be turned in as normal on the last working day of the month. If you are a non-exempt employee (hourly paid), your timesheet should be completed in One USG and reviewed every Friday to ensure all your work time is recorded and all absences have been submitted for approval. You must obtain supervisory approval within a timely manner before taking leave in accordance with established office procedures and institutional policy. Please continue to submit your leave requests to your immediate supervisor.

As an employee approved for telecommuting, you agree and understand that telecommuting requires that you be able to devote 100% commitment to working during the regular work hours specified above and that you will make arrangements to ensure that household duties, including child care, do not interfere with work time or are not conducted or performed during the normal work time.

4. TELEPHONE/COMPUTER/NETWORK & EQUIPMENT ACCESS & USE:

As an employee approved for telecommuting, you agree and understand that you will be expected to be accessible by telephone and thus will maintain a telephone line that can be used for phone calls at your own expense. To the extent possible, personnel at an institution’s primary location will call you

to minimize long distance expenses for you, but you agree and understand that there may be times when you will incur telephone charges in the performance of your duties and will do so at your own expense, without expectation of reimbursement. You further agree to have the phone line available to send and receive faxes as necessary. If your phone line cannot accept faxes, arrangements will be made to make any printer issued to you facsimile compatible.

Access to the information technology network and other applicable technology will be set up in accordance with EGSC policy.

If you are using institutionally issued IT equipment during the period of this telecommuting agreement you are authorized to use this computer and the network access referenced above in accordance with all applicable institutional computer use and information technology policies. Failure to adhere to institutional computing and IT use policies may result in revocation of use privileges, revocation of this telecommuting agreement, and possibly termination of employment. You will be required as a condition of employment to maintain internet access from your home office. Equipment issued to you is subject to the *IT Equipment/Software Usage Form and Agreement* which must be completed and approved prior to removal of state property from the regular work site.

You are subject to the *Information Technology Equipment Policy*. It will be your responsibility to ensure the appropriateness and safety of the equipment at all times. The equipment must be protected against damage and unauthorized use. EGSC owned equipment will be serviced and maintained by the EGSC. Equipment provided by the employee will be at no cost to EGSC and will be maintained by the employee.

You agree not to use EGSC owned equipment for personal purposes.

If you are expected to provide your own internet accessible computer and printer to support your work activities during the period of this telecommuting agreement, you will be required as a condition of employment to maintain internet access at your own expense.

5. WORK ASSIGNMENTS:

You will receive your work assignments by corresponding with your immediate supervisor daily at the beginning of the workday or as necessary during the day. Work assignments may also be communicated by phone, or other electronic means, or sent by mail. If there are any questions or concerns about your assignments, you are expected to inform your immediate supervisor of them at the time of receipt.

Once assignments have been completed you may send them via email or other method as designated by your immediate supervisor. You will be required to complete the Daily Telework Schedule form and return to your supervisor as directed.

6. PHYSICAL HOME OFFICE SPACE, LIABILITY:

You agree to have a designated work area in your home. If there are any injuries while you are working, the workers' compensation coverage will be limited to occurrences in the designated workspace (or during work-related travel). Also, if such an injury were to occur, it will be investigated in accordance with the standard workers' compensation procedures promulgated by the Georgia Department of Administrative Services (DOAS).

If there is an illness or injury, resulting from the condition of this home office arrangement, EGSC is released from any possible liability.

EGSC will not be liable for damages to the employee's property that results from participation in the telecommuting program. EGSC will not be responsible for visitors or family injured at the work site.

Under the terms of this agreement, you are responsible for setting up an appropriate work environment within your home. EGSC will not be responsible for any cost associated with the setup of a home office. Upon your request, EGSC will consult with you on any modifications or requirements to operate EGSC- owned equipment at the home office.

7. CURTAILMENT OF THE AGREEMENT:

The employee's supervisor or unit head may terminate participation in this agreement at any time. Management also reserves the right to remove the employee from the program at any time. Upon notification, the employee will be expected to report for work at the primary departmental office location or other location as assigned by the supervisor. The employee agrees to limit performance of officially assigned duties to the work location specified in paragraph 2. Failure to comply with this provision may result in termination of the Telecommuting Agreement, and other appropriate disciplinary action.

We look forward to working with you on this telecommuting assignment and will appreciate any input from you during this process on how we may assist you and our office with ensuring that you are productive and able to meet job expectations under this agreement.

I accept the terms and conditions of this agreement, as provided to me by the employer. I understand what is expected of me during the period of this telecommuting agreement. By signing below, I confirm the reasonable standards to include health and safety requirements (including an ergonomically sound workstation) and promise to maintain it in the condition for the duration of the telecommuting period.

If there are any concerns regarding this arrangement, I will immediately contact my immediate supervisor for clarification and resolution.

EGSC Policies

During the period of this agreement, the employee agrees that he/she shall be covered by all EGSC policies and procedures surrounding employment. The dates shown in the duration section are not to be construed as a contract and do not guarantee continuation of employment during the period.

Attachment Q

EGSC DAILY TELEWORK SCHEDULE

EMPLOYEE NAME		
DATE		
TIME	IDENTIFY TIME AS:	WORK DESCRIPTION (work performed; goals accomplished)
	CHOOSE ONE	
	CHOOSE ONE	
	CHOOSE ONE	
	CHOOSE ONE	
	CHOOSE ONE	
	CHOOSE ONE	
	CHOOSE ONE	
	CHOOSE ONE	
	CHOOSE ONE	
	CHOOSE ONE	
	CHOOSE ONE	
	CHOOSE ONE	
	CHOOSE ONE	
	CHOOSE ONE	
What technical difficulties or obstacles did you encounter while teleworking today?		

ARCHIVED
The COVID-19 Public Health Emergency Declaration ended at midnight on May 11, 2023.
Information for archival use only.

Attachment R

EGSC

Emergency Paid Sick Leave and Family Medical Leave Procedures

Effective: April 1, 2020

Expires: December 31, 2020

Under the Families First Coronavirus Response Act, qualified employees of EGSC are entitled to paid leave as they deal with various circumstances to the coronavirus COVID-19 public health emergency. These new requirements take effect on April 1, 2020 and expire on December 31, 2020.

Emergency Paid Sick Leave

Any employee (as defined by the Fair Labor Standards Act) regardless of their length of service, is eligible for emergency sick leave if the employee is, in connection of COVID-19:

- (7) subject to a federal, state, or local quarantine or isolation order;
- (8) advised by a health care provider to self-quarantine;
- (9) experiencing symptoms and seeking a medical diagnosis;
- (10) caring for an individual who is subject to (1) or (2);
- (11) caring for a son or daughter whose school or child care provider is closed or unavailable; or
- (12) experiencing any similar condition specified by the U.S. Department of Health and Human Services.

Full-time employees who meet at least one of these criteria may take up to 80 hours of paid leave. Affected part-time employees may take paid leave for up to their average number of hours worked over a two week period.

The pay for those employees who must be quarantined or isolated and/or are experiencing COVID-19 symptoms (criteria 1,2, and 3) is capped at \$511 per day and an aggregate total of \$5,110. The pay for those who are caring for someone else (criteria 4 and 5) is to be at least two-thirds (2/3) of their regular pay rate but capped at \$200 per day and an aggregate of \$2,000.

Covered employees are entitled to use this emergency paid sick leave before using any other accrued leave.

Expanded Family and Medical Leave

The Family and Medical Leave Act is amended to allow employees with at least thirty days of service who are caring for a son or daughter under 18 years of age whose school or child care provider is closed or unavailable due to COVID-19.

Affected employees are entitled to take this leave as part of their 12-week allotment under the FMLA. It does not add an additional 12 weeks onto the already existing 12 weeks of FMLA leave.

The first two weeks of leave under this provision are unpaid – as is customary under the FMLA. The employee may utilize these two weeks of unpaid leave, however, at the same time as the two weeks of emergency paid sick leave described above.

The remaining 10 weeks must be paid – unlike other leave under the FMLA. That pay is to be at least two-thirds (2/3) of their regular pay rate but capped at \$200 per day and an aggregate total of \$10,000.

Employees are to give as much notice as practicable when the need for leave is foreseeable.

Employees are to contact the Office of Human Resources regarding requests for Family Medical Leave.

ARCHIVED
The COVID-19 Public Health Emergency Declaration ended at midnight on May 11, 2023.
Information for archival use only.

Attachment S

EGSC Non-Closure Emergency Leave Procedures

Under the USG (USG) *Non-Closure Emergency Leave Procedures*, institutional presidents have the authority to allow **Leave with or Without Pay** for emergency leave where the institution remains open but with reduced operations.

While EGSC (EGSC) remains open, our operations have seen a significant reduction due to COVID-19. To support employees who are impacted by these reduced operations, the USG Human Resources Administrative Practice (HRAP) Manual provisions for Inclement Weather and Other Emergencies have been amended to include these *Non-Closure Emergency Leave Procedures* (in accordance with Board of Regents Policy 8.2.7.7). This gives presidents the discretion to compensate employees for hours not worked up to the equivalent of their regularly scheduled hours per week when there is not work for those employees to perform that is essential to college operations. This leave status option shall end no later than 120 days following its availability, and upon the emergency's conclusion, or upon the reestablishment of normal operations.

The President of EGSC has the authority to implement a reduced operations plan to benefit as many eligible employees as possible during this emergency while also enabling the College to sustain essential on-campus services and provide for continuity of instruction.

Employees eligible for Non-Closure Emergency Leave include regular full-time and regular part-time employees who:

1. are not able to perform their regular duties through telework or other remote and flexible work arrangements, and
2. are working a partial schedule on campus as an essential employee; or
3. are not working at all due to lack of work and #1

If Non-closure Emergency Leave is paid, employees are to be compensated for hours not worked up to the equivalent of their regularly scheduled hours per week. Where partial work hours are available, the employee will be expected to perform their assigned duties; the remainder of the work week up to the equivalent of the hours regularly scheduled per week will be classified as Non-Closure Emergency Leave. For example, employee A normally works 40 hours per week and cannot work remotely.

Through rotational scheduling, employee A is now scheduled to work in support of essential on campus services for 8 hours on Monday and 8 hours on Thursday. Employee A should be paid the 24

hours of work for Tuesday, Wednesday, and Friday will be classified as Non-Closure Emergency Leave and the employee should be paid 16 hours of regular pay for Monday and Thursday.

Managers/supervisors who identify employees in their department that are unable to perform their duties as described above, must provide justification on why the employee(s) is unable to work. The manager/supervisor must conduct due diligence in identifying work available in the employee's department. The manager/supervisor must have their respective Vice Presidents approval.

The manager/supervisor will complete the *Non-Closure Emergency Leave Template* and submit to the Director of Human Resources and the Vice President for Business Affairs. The Director of Human Resources will submit all documentation to the President for consideration. Upon the President's approval or denial, the Director of Human Resources will notify the respective Vice President and manager/supervisor of the decision. For approved Non-Closure Emergency Leave, a Personnel Action Request will be sent to payroll for processing.



Attachment T

Non-Closure Emergency Leave Justification Template

Department and Contact Information

Department Name:	
Submitted by (name):	Email Address:
Contact Number:	

Employee Position Data

<input type="checkbox"/> Full-time <input type="checkbox"/> Part-time <input type="checkbox"/> Regular Employee <input type="checkbox"/> Part-time Employee	
Employee Job Title:	Employee Current Pay Rate:
Department:	Work Location: Swainsboro / Statesboro / Augusta
Work Schedule	Monday / Tuesday / Wednesday / Thursday / Friday List Works Hours:
Describe the main job duties of the employees job:	
Based on the employee's job duties, is this employee able to telework from home and is flex-scheduling available? Please describe.	

What other alternatives or organization strategies have been considered?
Please provide detailed justification on why this employee meets the criteria for Paid Non-Closure Emergency Leave.

Approvals:

This signed form must be scanned or signed electronically and submitted to the Director of Human Resources. This request will not be accepted or considered without being signed.

Manager/Supervisor: _____ Date: _____

Vice President: _____ Date: _____

President: _____ Date: _____

Attachment V



Kathleen E. Toomey, M.D., M.P.H., Commissioner

Brian Kemp, Governor

2 Peachtree Street, NW, 15th Floor
Atlanta, Georgia 30303-3142

dph.ga.gov

Return to Work Guidance After COVID-19 Illness or Exposure for Persons Who Are Not Healthcare Personnel

May 21, 2020

If assessing a healthcare worker, please review DPH Healthcare Worker Return to Work Guidance
<https://dph.georgia.gov/document/document/dph-return-work-guidance-03-26-2020/download>

The following guidance should be used to make decisions about “return to work” for persons who are not Healthcare Personnel:

- with laboratory-confirmed COVID-19;
- who have suspected COVID-19 (e.g., developed symptoms of a respiratory infection [e.g., cough, shortness of breath, fever] but did not get tested for COVID-19 and have been exposed to a person with COVID-19 or live in an area with local or widespread transmission;
- who have been exposed to COVID-19 without appropriate personal protective equipment (PPE).

Return to Work Strategy

DPH recommends a time-based return to work strategy that is determined based on a person’s health status. Decisions about “return to work” for persons with confirmed or suspected COVID-19 who are not healthcare personnel should be made in the context of local circumstances (community transmission, resource needs, etc.).

- Symptomatic persons who are not healthcare personnel with confirmed COVID-19 or suspected COVID-19 can return to work after:
 - At least 3 days (72 hours) have passed *since recovery* defined as resolution of fever without the use of fever-reducing medications AND improvement in respiratory symptoms (e.g., cough, shortness of breath); AND,
 - At least 10 days have passed *since symptoms first appeared*
- Asymptomatic persons who are not healthcare personnel with confirmed COVID-19 can return to work after:
 - At least 10 days have passed since the positive laboratory test and the person remains asymptomatic.
 - Note, asymptomatic persons who test positive and later develop symptoms should follow the guidance for symptomatic persons above
- Asymptomatic persons who are not healthcare personnel, and who do not work in critical infrastructure who have a known exposure to a person with COVID-19 without appropriate PPE can return to work after:
 - After their 14-day home quarantine period has ended (i.e. 14 days have passed since the

last exposure without appropriate PPE). PPE includes: a mask, eye cover or face shield, and gloves. A gown and respirator (e.g., N95) should be used during aerosol generating procedures. For PPE guidance: <https://www.cdc.gov/coronavirus/2019-ncov/infection-control/control-recommendations.html>.

- If this person is tested for COVID-19 during the 14-day quarantine period, a negative test result would not change or decrease the time a person is monitored, but a positive test would move the person into one of the above categories, based on whether they are still asymptomatic or have developed symptoms.
- Asymptomatic persons who are not healthcare personnel, but who do work in critical infrastructure who have a known exposure to a person with COVID-19 can follow the CDC guidance for return to work:
 - <https://www.cdc.gov/coronavirus/2019-ncov/community/critical-workers/implementing-safety-practices.html>

DPH **DOES NOT** recommend using a test-based strategy for returning to work (2 negative tests at least 24 hours apart) after COVID-19 infection for non-healthcare personnel.* CDC has reported prolonged PCR positive test results without evidence of infectiousness. Although persons may have PCR-positive tests for up to 6 weeks, it remains unknown whether these PCR-positive results represent the presence of infectious virus. At this time, PCR positive specimens capable of producing disease have not been isolated more than 9 days after onset of illness.

More information about the science behind the symptom-based return to work can be found at: <https://www.cdc.gov/coronavirus/2019-ncov/community/strategy-discontinue-isolation.html>

Return to Work Practices and Work Restrictions

Persons who are not healthcare personnel who complete the above conditions and can return to work should:

- Wear a face covering if social distancing cannot be maintained in the workplace, per current CDC guidelines: <https://www.cdc.gov/coronavirus/2019-ncov/prevent-getting-sick/cloth-face-cover.html>. Note: A facemask, instead of a cloth face covering, should be used by healthcare providers only. Cloth face coverings are appropriate for persons who are not healthcare personnel and are recommended by CDC to help prevent asymptomatic spread of COVID-19 in settings where social distancing cannot be practiced.
- Adhere to hand hygiene, respiratory hygiene, and cough etiquette in [CDC's interim infection control guidance](#) (e.g., cover nose and mouth when coughing or sneezing, dispose of tissues in waste receptacles)
- Self-monitor for symptoms and seek re-evaluation from occupational health if respiratory symptoms recur or worsen.

CDC guidance for discontinuation of home isolation for persons with COVID-19 infection not in a healthcare setting can be used in conjunction with this guidance for returning to work and school and can be found at <https://www.cdc.gov/coronavirus/2019-ncov/hcp/disposition-in-home-patients.html>

** Completing a test-based strategy is contingent upon the availability of ample testing supplies, laboratory capacity, and convenient access to testing and requires two samples taken at least 24 hours apart. If an employer requires the test-based strategy for return (which is discouraged by DPH), this should be done by a private physician through a commercial lab. The test-based strategy is not fulfilled by a single test, nor should it be used for screening of all persons returning to work.*

ARCHIVED
The COVID-19 Public Health Emergency Declaration ended at midnight on May 11, 2023.
Information for archival use only.